

AIR CONDITIONER

Wall mounted type

DESIGN & TECHNICAL MANUAL

INDOOR



ASUH18LPAS
ASUH24LPAS

OUTDOOR



AOUH18LPAS1
AOUH24LPAS1

FUJITSU GENERAL LIMITED

Notices:

- Product specifications and design are subject to change without notice for future improvement.
- For further details, please check with our authorized dealer.

Trademarks

FGLair™ is trademark of Fujitsu General Limited in the United States, other countries or both.

Google Play™ is trademark of Google Inc.

App Store® is a service mark of Apple Inc., registered in the U.S. and other countries.

CONTENTS

Part 1. INDOOR UNIT	1
1. Specifications	2
2. Dimensions	4
2-1. Models: ASUH18LPAS and ASUH24LPAS	4
3. Wiring diagrams	6
3-1. Models: ASUH18LPAS and ASUH24LPAS	6
4. Capacity table	7
4-1. Cooling capacity.....	7
4-2. Heating capacity	9
5. Fan performance	10
5-1. Air velocity distributions.....	10
5-2. Airflow	12
6. Operation noise (sound pressure)	14
6-1. Noise level curve.....	14
6-2. Sound level check point	15
7. Safety devices	16
8. External input and output	17
8-1. External input.....	18
8-2. External output.....	20
8-3. Combination of external input and output.....	22
8-4. Details of function	24
9. Group connection	46
10. Remote controller	47
10-1. Wireless remote controller	47
11. Function settings	50
11-1. Function settings by using remote controller.....	50
11-2. Custom code setting for wireless remote controller.....	59
12. Accessories	60
12-1. Models: ASUH18LPAS and ASUH24LPAS	60
13. Optional parts	61
13-1. Controllers	61
13-2. Others	62

CONTENTS (continued)

Part 2. OUTDOOR UNIT	63
1. Specifications	64
2. Dimensions	65
2-1. Models: AOUH18LPAS1 and AOUH24LPAS1	65
3. Installation space	66
3-1. Models: AOUH18LPAS1 and AOUH24LPAS1	66
4. Refrigerant circuit	69
4-1. Models: AOUH18LPAS1 and AOUH24LPAS1	69
5. Wiring diagrams	70
5-1. Models: AOUH18LPAS1 and AOUH24LPAS1	70
6. Capacity compensation rate for pipe length and height difference	71
6-1. Models: AOUH18LPAS1 and AOUH24LPAS1	71
7. Additional charge calculation	72
7-1. Models: AOUH18LPAS1 and AOUH24LPAS1	72
8. Airflow	73
8-1. Model: AOUH18LPAS1.....	73
8-2. Model: AOUH24LPAS1.....	73
9. Operation noise (sound pressure)	74
9-1. Noise level curve.....	74
9-2. Sound level check point	75
10. Electrical characteristics	76
11. Safety devices	77
12. Accessories	78
12-1. Models: AOUH18LPAS1 and AOUH24LPAS1	78

Part 1. INDOOR UNIT

WALL MOUNTED TYPE:

ASUH18LPAS

ASUH24LPAS

1. Specifications

Type				Wall mounted		
				Inverter heat pump		
Model name				ASUH18LPAS	ASUH24LPAS	
Power supply				208/230 V ~ 60 Hz		
Power supply intake				Outdoor unit		
Available voltage range				187—253 V		
Capacity	Cooling	Rated	kW	5.28	7.03	
			Btu/h	18,000	24,000	
		Min.—Max.	kW	1.17—5.57	1.17—7.15	
			Btu/h	4,000—19,000	4,000—24,400	
	Heating	Rated	kW	5.28	7.03	
			Btu/h	18,000	24,000	
		Min.—Max.	kW	0.82—7.03	0.85—8.50	
			Btu/h	2,800—24,000	2,900—29,000	
	Heating (17 °F) ¹	Rated	kW	3.28	4.51	
			Btu/h	11,200	15,400	
Max.		kW	4.40	5.57		
		Btu/h	15,000	19,000		
Input power	Cooling	Rated	kW	1.50	2.60	
		Min.—Max.		0.15—1.90	0.15—3.20	
	Heating	Rated		1.33	2.07	
		Min.—Max.		0.15—2.10	0.15—3.10	
	Heating (17 °F) ¹	Rated		1.12	1.58	
		Max.		1.70	2.20	
Current	Cooling	Rated	A	6.7	11.4	
	Heating		5.9	9.1		
EER	Cooling	kW/kW	3.52	2.70		
		Btu/hW	12.0	9.2		
COP	Heating	kW/kW	3.97	3.40		
		Btu/hW	13.5	11.6		
SEER	Cooling	Btu/hW	20.0	19.0		
HSPF	Heating	Btu/hW	11.0	11.0		
Power factor	Cooling		%	97.3	99.2	
	Heating		98.0	98.9		
Moisture removal			pints/h (L/h)	4.0 (1.9)	6.3 (3.0)	
Maximum operating current* ²			Cooling	A	9.9	
			Heating	11.9	13.9	
Fan	Airflow rate	Cooling	HIGH	CFM (m ³ /h)	530 (900)	642 (1,090)
			MED		471 (800)	471 (800)
			LOW		377 (640)	377 (640)
			QUIET		241 (410)	306 (520)
		Heating	HIGH		506 (860)	594 (1,010)
			MED		406 (690)	506 (860)
			LOW		330 (560)	377 (640)
			QUIET		247 (420)	306 (520)
	Type × Q'ty			Crossflow fan × 1		
	Motor output			W	59	
Sound pressure level* ³	Cooling	HIGH	dB (A)	44	49	
				MED	42	
				LOW	37	
				QUIET	26	31
	Heating	HIGH		43	47	
				MED	39	43
				LOW	34	37
				QUIET	28	32
Heat exchanger type	Dimensions (H × W × D)		in (mm)	Main1: 8-1/4 × 31-5/16 × 1-1/16 (210 × 796 × 26.6) Main2: 4-15/16 × 31-5/16 × 1-1/16 (126 × 796 × 26.6) Sub1: 3-5/16 × 31-5/16 × 1/2 (84 × 796 × 13.3)		
	Fin pitch		FPI	Man1: 21 Main2: 21 Sub1: 18		
	Rows × Stages			Main1: 2 × 10 Main2: 2 × 6 Sub1: 1 × 4		
	Pipe type			Copper		
	Fin type			Aluminum		
	Material			Polystyrene		
Enclosure			White			
Color			Approximate color of Munsell N 9.25/			
Dimensions (H × W × D)	Net	in (mm)	11 × 38-9/16 × 9-7/16 (280 × 980 × 240)			
	Gross		12-11/16 × 42-7/16 × 13-5/8 (322 × 1,078 × 346)			
Weight	Net	lb (kg)	29 (13)			
	Gross		37 (17)			
Connection pipe	Size	Liquid Gas	in (mm)	Ø 1/4 (6.35)		
				Ø 1/2 (Ø 12.7)		
	Method			Flare		
Drain hose			PP+HDPE			
Tip diameter		in (mm)	Ø17/32 (Ø 13.8) (I.D.), Ø5/8 to 21/32 (Ø 15.8 to 16.7) (O.D.)			
Operation range	Cooling	°F (°C)	64 to 90 (18 to 32)			
	Heating	%RH	80 or less			
		°F (°C)	86 or less (30 or less)			
Remote controller type				Wireless (Wired, Mobile app* ⁴ [FGLair™] [option])		

Type	Wall mounted	
	Inverter heat pump	
Model name	ASUH18LPAS	ASUH24LPAS
<p>NOTES:</p> <ul style="list-style-type: none"> • Specifications are based on the following conditions: <ul style="list-style-type: none"> – Cooling: Indoor temperature of 80 °FDB (26.67 °CDB) /67 °FWB (19.44 °CWB), and outdoor temperature of 95 °FDB (35 °CDB) / 75 °FWB (23.9 °CWB). – Heating: Indoor temperature of 70 °FDB (21.11 °CDB) /59 °FWB (15.56 °CWB), and outdoor temperature of 47 °FDB (8.33 °CDB) /43 °FWB (6.11 °CWB). – *1: Heating (17 °F): Indoor temperature of 70 °FDB (21.11 °CDB) /60 °FWB (15.56 °CWB), and outdoor temperature of 17 °FDB (-8.33 °CDB) /15 °FWB (-9.44 °CWB). – Pipe length: 25 ft (7.5 m), Height difference: 0 ft (0 m). (Between outdoor unit and indoor unit.) • Protective function might work when using it outside the operation range. • *2: Maximum current is maximum value when operated within the operation range. • *3: Sound pressure level: <ul style="list-style-type: none"> – Measured values in manufacturer's anechoic chamber. – Because of the surrounding sound environment, the sound levels measured in actual installation conditions might be higher than the specified values here. • *4: Available on Google Play™ store or on App Store®. Optional WLAN adapter is also required. For details, refer to the setting manual. 		

2. Dimensions

2-1. Models: ASUH18LPAS and ASUH24LPAS

Unit: in (mm)

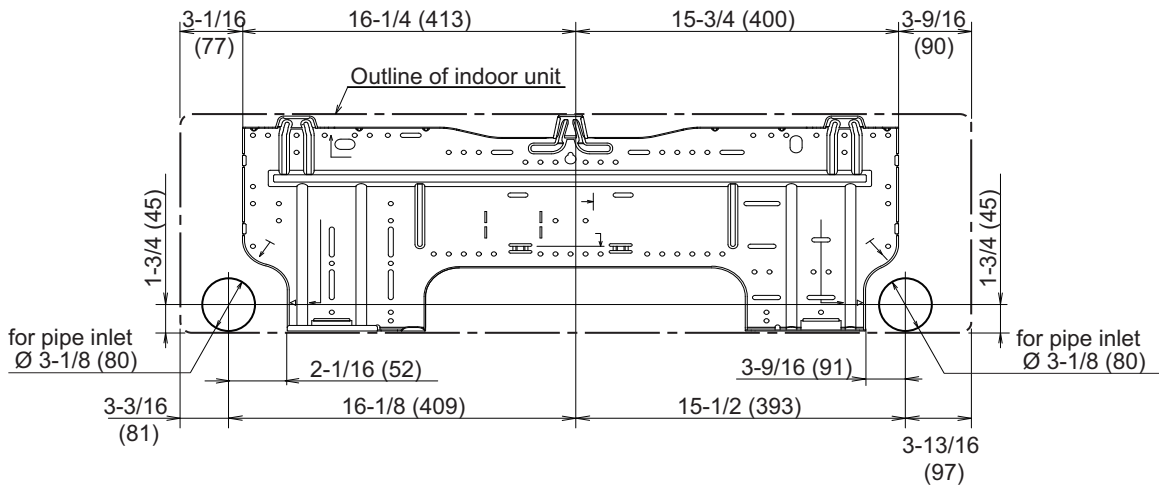
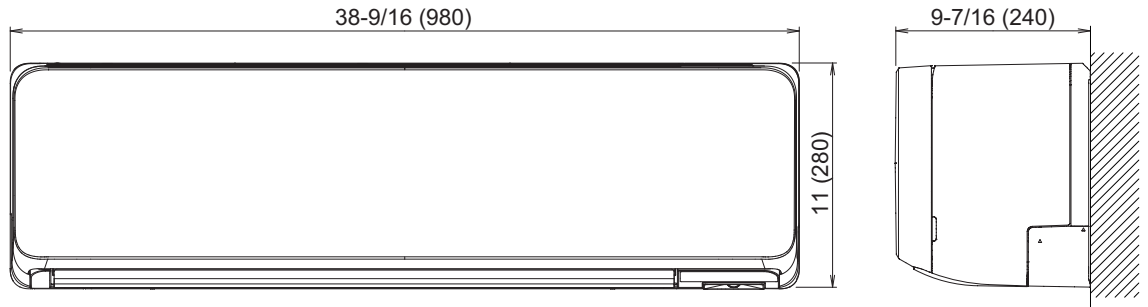

■ Installation space requirement

Provide sufficient installation space for product safety.

Unit: in (mm)

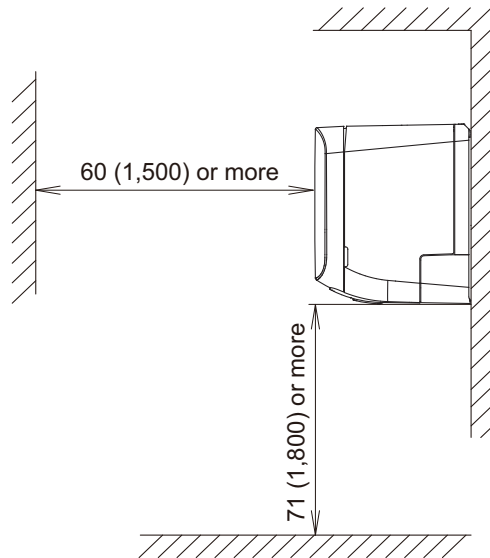
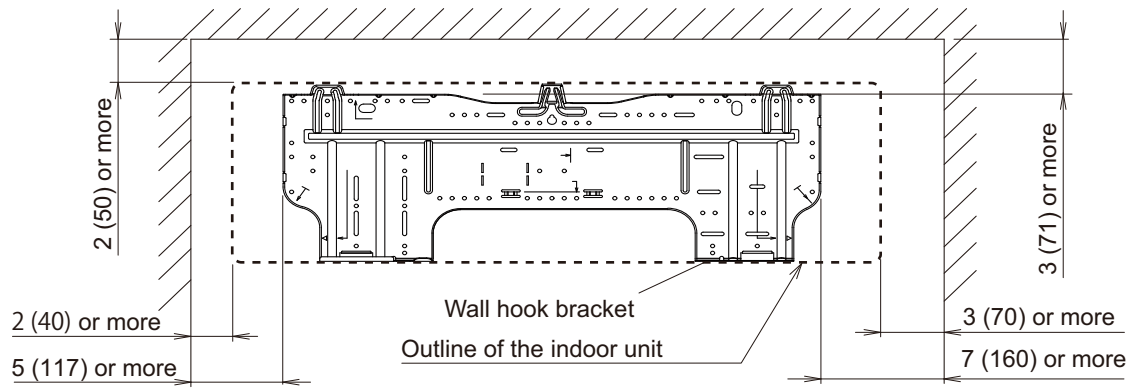

3. Wiring diagrams

3-1. Models: ASUH18LPAS and ASUH24LPAS

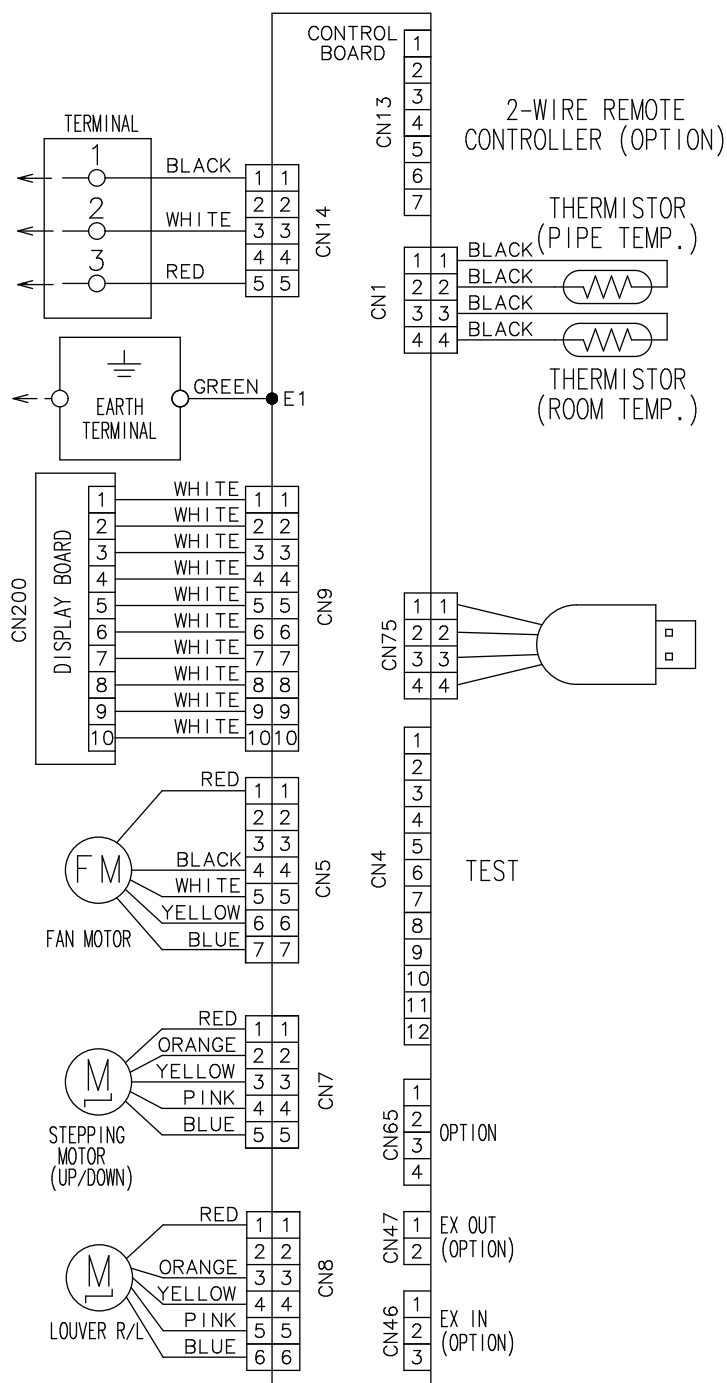

4. Capacity table

Capacity tables show each of following values calculated based on the outdoor temperature and the indoor temperature, under given Airflow Rate (AFR):

For cooling capacity: Total Capacity (TC), Sensible Heat Capacity (SHC), and Input Power (IP)

For heating capacity: Total Capacity (TC) and Input Power (IP)

4-1. Cooling capacity

■ Model: ASUH18LPAS

AFR		CFM		530																	
		Indoor temperature																			
		64			70			75			80			85			90				
		54			60			63			67			71			73				
Outdoor temperature	°FDB	TC	SHC	IP	TC	SHC	IP	TC	SHC	IP	TC	SHC	IP	TC	SHC	IP	TC	SHC	IP		
	°FWB	kBtu	kW	kBtu	kW	kBtu	kW	kBtu	kW	kBtu	kW	kBtu	kW	kBtu	kW	kBtu	kW	kBtu	kW		
14	13.54	9.85	0.39	14.82	10.78	0.40	16.24	11.82	0.41	16.74	12.18	0.41	17.84	12.98	0.41	19.02	13.84	0.42			
23	13.34	9.68	0.42	14.60	10.60	0.43	16.00	11.61	0.44	16.49	11.97	0.44	17.57	12.76	0.44	18.73	13.60	0.45			
32	13.14	9.51	0.45	14.38	10.41	0.46	15.75	11.41	0.47	16.24	11.76	0.47	17.31	12.53	0.47	18.45	13.36	0.48			
41	12.94	9.34	0.45	14.15	10.22	0.46	15.51	11.20	0.47	15.99	11.55	0.47	17.04	12.31	0.47	18.16	13.12	0.48			
50	12.66	9.11	0.46	13.85	9.97	0.47	15.18	10.92	0.48	15.65	11.26	0.48	16.68	12.00	0.48	17.78	12.79	0.49			
59	12.46	8.94	0.49	13.63	9.78	0.49	14.94	10.72	0.50	15.40	11.05	0.51	16.41	11.77	0.52	17.49	12.55	0.52			
67	14.35	10.54	0.81	15.70	11.53	0.81	17.21	12.64	0.83	17.74	13.03	0.84	18.90	13.88	0.85	20.15	14.80	0.86			
77	14.42	10.64	1.02	15.78	11.64	1.03	17.29	12.76	1.05	16.85	12.28	0.94	19.00	14.02	1.07	20.25	14.94	1.08			
87	14.49	10.74	1.23	15.86	11.75	1.24	17.38	12.88	1.27	19.07	14.20	1.36	19.09	14.15	1.29	20.35	15.08	1.31			
95	14.56	10.84	1.44	15.93	11.86	1.46	17.46	13.00	1.49	18.00	13.40	1.50	19.18	14.28	1.52	20.45	15.22	1.53			
104	13.19	9.55	1.42	14.43	10.45	1.44	15.81	11.45	1.47	16.30	11.80	1.48	17.37	12.57	1.49	18.52	13.41	1.51			
115	12.30	8.66	1.39	13.46	9.47	1.41	14.75	10.38	1.44	15.20	10.70	1.45	16.20	11.40	1.46	17.27	12.16	1.48			

AFR		m ³ /h		900																	
		Indoor temperature																			
		17.8			21.1			23.9			26.7			29.4			32.2				
		12.2			15.6			17.2			19.4			21.7			22.8				
Outdoor temperature	°CDB	TC	SHC	IP	TC	SHC	IP	TC	SHC	IP	TC	SHC	IP	TC	SHC	IP	TC	SHC	IP		
	°CWB	kW			kW			kW			kW			kW			kW				
-10.0	3.97	2.89	0.39	4.34	3.16	0.40	4.76	3.46	0.41	4.91	3.57	0.41	5.23	3.80	0.41	5.57	4.06	0.42			
-5.0	3.91	2.84	0.42	4.28	3.11	0.43	4.69	3.40	0.44	4.83	3.51	0.44	5.15	3.74	0.44	5.49	3.99	0.45			
0.0	3.85	2.79	0.45	4.21	3.05	0.46	4.62	3.34	0.47	4.76	3.45	0.47	5.07	3.67	0.47	5.41	3.92	0.48			
5.0	3.79	2.74	0.45	4.15	3.00	0.46	4.55	3.28	0.47	4.69	3.39	0.47	4.99	3.61	0.47	5.32	3.85	0.48			
10.0	3.71	2.67	0.46	4.06	2.92	0.47	4.45	3.20	0.48	4.59	3.30	0.48	4.89	3.52	0.48	5.21	3.75	0.49			
15.0	3.65	2.62	0.49	4.00	2.87	0.49	4.38	3.14	0.50	4.51	3.24	0.51	4.81	3.45	0.52	5.13	3.68	0.52			
19.4	4.21	3.09	0.81	4.60	3.38	0.81	5.04	3.70	0.83	5.20	3.82	0.84	5.54	4.07	0.85	5.91	4.34	0.86			
25.0	4.23	3.12	1.02	4.62	3.41	1.03	5.07	3.74	1.05	4.94	3.60	0.94	5.57	4.11	1.07	5.94	4.38	1.08			
30.6	4.25	3.15	1.23	4.65	3.44	1.24	5.09	3.77	1.27	5.59	4.16	1.36	5.59	4.15	1.29	5.96	4.42	1.31			
35.0	4.27	3.18	1.44	4.67	3.48	1.46	5.12	3.81	1.49	5.28	3.93	1.50	5.62	4.18	1.52	5.99	4.46	1.53			
40.0	3.86	2.80	1.42	4.23	3.06	1.44	4.63	3.35	1.47	4.78	3.46	1.48	5.09	3.69	1.49	5.43	3.93	1.51			
46.1	3.60	2.54	1.39	3.94	2.78	1.41	4.32	3.04	1.44	4.45	3.14	1.45	4.75	3.34	1.46	5.06	3.56	1.48			

Model: ASUH24LPAS

AFR	CFM	642
-----	-----	-----

		Indoor temperature																	
		64			70			75			80			85			90		
		54			60			63			67			71			73		
Outdoor temperature	°FDB	TC	SHC	IP	TC	SHC	IP	TC	SHC	IP	TC	SHC	IP	TC	SHC	IP	TC	SHC	IP
	°FWB	kBTu			kBTu			kBTu			kBTu			kBTu			kBTu		
		kW			kW			kW			kW			kW			kW		
	14	17.34	11.91	0.50	18.98	13.03	0.50	20.80	14.28	0.51	21.44	14.72	0.52	22.85	15.69	0.53	24.36	16.72	0.53
	23	17.08	11.70	0.53	18.69	12.80	0.53	20.48	14.03	0.54	21.12	14.46	0.55	22.50	15.41	0.56	23.99	16.43	0.56
	32	16.82	11.49	0.56	18.40	12.57	0.56	20.17	13.78	0.57	20.79	14.20	0.58	22.15	15.13	0.59	23.62	16.13	0.59
	41	16.56	11.28	0.57	18.12	12.34	0.57	19.86	13.52	0.58	20.47	13.94	0.59	21.81	14.85	0.60	23.25	15.84	0.60
	50	16.30	11.07	0.58	17.84	12.11	0.58	19.55	13.27	0.59	20.15	13.68	0.60	21.47	14.58	0.61	22.89	15.54	0.61
	59	16.24	11.01	0.62	17.77	12.05	0.63	19.47	13.20	0.64	20.07	13.61	0.65	21.39	14.50	0.66	22.80	15.46	0.66
	67	18.39	12.76	1.00	20.12	13.96	1.01	22.05	15.30	1.03	22.73	15.77	1.04	24.22	16.80	1.05	25.82	17.92	1.06
77	18.73	13.09	1.50	20.50	14.32	1.51	22.46	15.70	1.54	21.68	14.92	1.17	24.67	17.24	1.58	26.30	18.38	1.59	
87	19.07	13.42	2.00	20.87	14.69	2.02	22.87	16.09	2.06	25.40	18.00	2.36	25.12	17.68	2.10	26.78	18.85	2.12	
95	19.42	13.75	2.50	21.24	15.05	2.52	23.28	16.49	2.57	24.00	17.00	2.60	25.57	18.12	2.63	27.26	19.31	2.65	
104	17.47	12.05	2.46	19.12	13.19	2.48	20.95	14.45	2.53	21.60	14.90	2.56	23.02	15.88	2.59	24.54	16.93	2.61	
115	16.42	11.00	2.41	17.97	12.04	2.43	19.69	13.19	2.48	20.30	13.60	2.51	21.63	14.49	2.54	23.06	15.45	2.56	

AFR	m³/h	1,090
-----	------	-------

		Indoor temperature																	
		17.8			21.1			23.9			26.7			29.4			32.2		
		12.2			15.6			17.2			19.4			21.7			22.8		
Outdoor temperature	°CDB	TC	SHC	IP	TC	SHC	IP	TC	SHC	IP	TC	SHC	IP	TC	SHC	IP	TC	SHC	IP
	°CWB	kW			kW			kW			kW			kW			kW		
	-10.0	5.08	3.49	0.50	5.56	3.82	0.50	6.10	4.19	0.51	6.28	4.31	0.52	6.70	4.60	0.53	7.14	4.90	0.53
	-5.0	5.01	3.43	0.53	5.48	3.75	0.53	6.00	4.11	0.54	6.19	4.24	0.55	6.59	4.52	0.56	7.03	4.81	0.56
	0.0	4.93	3.37	0.56	5.39	3.68	0.56	5.91	4.04	0.57	6.09	4.16	0.58	6.49	4.43	0.59	6.92	4.73	0.59
	5.0	4.85	3.31	0.57	5.31	3.62	0.57	5.82	3.96	0.58	6.00	4.09	0.59	6.39	4.35	0.60	6.82	4.64	0.60
	10.0	4.78	3.24	0.58	5.23	3.55	0.58	5.73	3.89	0.59	5.91	4.01	0.60	6.29	4.27	0.61	6.71	4.55	0.61
	15.0	4.76	3.23	0.62	5.21	3.53	0.63	5.71	3.87	0.64	5.88	3.99	0.65	6.27	4.25	0.66	6.68	4.53	0.66
	19.4	5.39	3.74	1.00	5.90	4.09	1.01	6.46	4.48	1.03	6.66	4.62	1.04	7.10	4.93	1.05	7.57	5.25	1.06
	25.0	5.49	3.84	1.50	6.01	4.20	1.51	6.58	4.60	1.54	6.35	4.37	1.17	7.23	5.05	1.58	7.71	5.39	1.59
30.6	5.59	3.93	2.00	6.12	4.30	2.02	6.70	4.72	2.06	7.44	5.28	2.36	7.36	5.18	2.10	7.85	5.52	2.12	
35.0	5.69	4.03	2.50	6.23	4.41	2.52	6.82	4.83	2.57	7.03	4.98	2.60	7.50	5.31	2.63	7.99	5.66	2.65	
40.0	5.12	3.53	2.46	5.60	3.87	2.48	6.14	4.24	2.53	6.33	4.37	2.56	6.75	4.65	2.59	7.19	4.96	2.61	
46.1	4.81	3.22	2.41	5.27	3.53	2.43	5.77	3.87	2.48	5.95	3.99	2.51	6.34	4.25	2.54	6.76	4.53	2.56	

4-2. Heating capacity

NOTE: Values mentioned in the table are calculated based on the maximum capacity.

Model: ASUH18LPAS

AFR	CFM	506
-----	-----	-----

Outdoor temperature		Indoor temperature											
		°FDB	°FWB	60		65		70		72		75	
				TC kBtu	IP kW	TC kBtu	IP kW	TC kBtu	IP kW	TC kBtu	IP kW	TC kBtu	IP kW
5	3	19.63	2.40	19.11	2.45	18.60	2.50	18.09	2.55	17.57	2.60		
14	12	20.89	2.08	20.35	2.12	19.80	2.17	19.25	2.21	18.71	2.25		
23	19	21.78	2.01	21.21	2.05	20.64	2.09	20.07	2.13	19.50	2.17		
32	28	21.91	1.91	21.33	1.95	20.76	1.99	20.19	2.03	19.61	2.07		
41	37	24.06	1.96	23.43	2.00	22.80	2.04	22.17	2.08	21.54	2.12		
47	43	25.33	2.02	24.66	2.06	24.00	2.10	23.34	2.14	22.67	2.18		
50	47	27.98	2.04	27.25	2.09	26.52	2.13	24.77	2.17	24.77	2.21		
59	50	29.00	2.05	28.24	2.09	27.48	2.14	24.77	2.18	24.77	2.22		
68	59	25.99	1.68	25.31	1.71	24.63	1.75	23.95	1.78	23.27	1.82		
75	64	26.14	1.53	25.45	1.56	24.77	1.59	24.09	1.62	23.40	1.65		

AFR	m ³ /h	860
-----	-------------------	-----

Outdoor temperature		Indoor temperature											
		°CDB	°CWB	15.6		18.3		21.1		22.2		23.9	
				TC kW	IP kW	TC kW	IP kW	TC kW	IP kW	TC kW	IP kW	TC kW	IP kW
-15.0	-16.1	5.75	2.40	5.60	2.45	5.45	2.50	5.30	2.55	5.15	2.60		
-10.0	-11.1	6.12	2.08	5.96	2.12	5.80	2.17	5.64	2.21	5.48	2.25		
-5.0	-7.2	6.38	2.01	6.22	2.05	6.05	2.09	5.88	2.13	5.72	2.17		
0.0	-2.2	6.42	1.91	6.25	1.95	6.08	1.99	5.92	2.03	5.75	2.07		
5.0	2.8	7.05	1.96	6.87	2.00	6.68	2.04	6.50	2.08	6.31	2.12		
8.3	6.1	7.42	2.02	7.23	2.06	7.03	2.10	6.84	2.14	6.65	2.18		
10.0	8.3	8.20	2.04	7.99	2.09	7.77	2.13	7.26	2.17	7.26	2.21		
15.0	10.0	8.50	2.05	8.28	2.09	8.05	2.14	7.26	2.18	7.26	2.22		
20.0	15.0	7.62	1.68	7.42	1.71	7.22	1.75	7.02	1.78	6.82	1.82		
24.0	18.0	7.66	1.53	7.46	1.56	7.26	1.59	7.06	1.62	6.86	1.65		

Model: ASUH24LPAS

AFR	CFM	594
-----	-----	-----

Outdoor temperature		Indoor temperature											
		°FDB	°FWB	60		65		70		72		75	
				TC kBtu	IP kW	TC kBtu	IP kW	TC kBtu	IP kW	TC kBtu	IP kW	TC kBtu	IP kW
5	3	20.58	2.74	20.04	2.79	19.50	2.85	18.96	2.90	18.42	2.96		
14	12	25.27	3.07	24.61	3.13	23.95	3.20	23.29	3.26	22.63	3.32		
23	19	26.30	2.97	25.61	3.03	24.92	3.09	24.23	3.15	23.54	3.21		
32	28	26.52	2.81	25.82	2.87	25.13	2.93	24.44	2.99	23.74	3.04		
41	37	29.02	2.88	28.26	2.94	27.50	3.00	26.74	3.06	25.98	3.11		
47	43	30.60	2.98	29.80	3.03	29.00	3.10	28.20	3.16	27.40	3.22		
50	47	33.78	3.02	32.89	3.08	32.01	3.15	29.92	3.21	29.92	3.27		
59	50	35.14	3.03	34.22	3.09	33.30	3.16	29.92	3.22	29.92	3.28		
68	59	31.39	2.27	30.57	2.31	29.75	2.36	28.93	2.41	28.11	2.45		
75	64	31.57	2.05	30.75	2.09	29.92	2.14	29.09	2.18	28.27	2.22		

AFR	m ³ /h	1,010
-----	-------------------	-------

Outdoor temperature		Indoor temperature											
		°CDB	°CWB	15.6		18.3		21.1		22.2		23.9	
				TC kW	IP kW	TC kW	IP kW	TC kW	IP kW	TC kW	IP kW	TC kW	IP kW
-15.0	-16.1	6.03	2.74	5.87	2.79	5.72	2.85	5.56	2.90	5.40	2.96		
-10.0	-11.1	7.41	3.07	7.21	3.13	7.02	3.20	6.83	3.26	6.63	3.32		
-5.0	-7.2	7.71	2.97	7.51	3.03	7.30	3.09	7.10	3.15	6.90	3.21		
0.0	-2.2	7.77	2.81	7.57	2.87	7.37	2.93	7.16	2.99	6.96	3.04		
5.0	2.8	8.51	2.88	8.28	2.94	8.06	3.00	7.84	3.06	7.61	3.11		
8.3	6.1	8.97	2.98	8.73	3.03	8.50	3.10	8.26	3.16	8.03	3.22		
10.0	8.3	9.90	3.02	9.64	3.08	9.38	3.15	8.77	3.21	8.77	3.27		
15.0	10.0	10.30	3.03	10.03	3.09	9.76	3.16	8.77	3.22	8.77	3.28		
20.0	15.0	9.20	2.27	8.96	2.31	8.72	2.36	8.48	2.41	8.24	2.45		
24.0	18.0	9.25	2.05	9.01	2.09	8.77	2.14	8.53	2.18	8.28	2.22		

5. Fan performance

5-1. Air velocity distributions

Model: ASUH18LPAS

Measuring conditions	Fan speed	Operation mode
	HIGH	FAN

Top view
Vertical airflow direction louver: Up
Horizontal airflow direction louver: Center

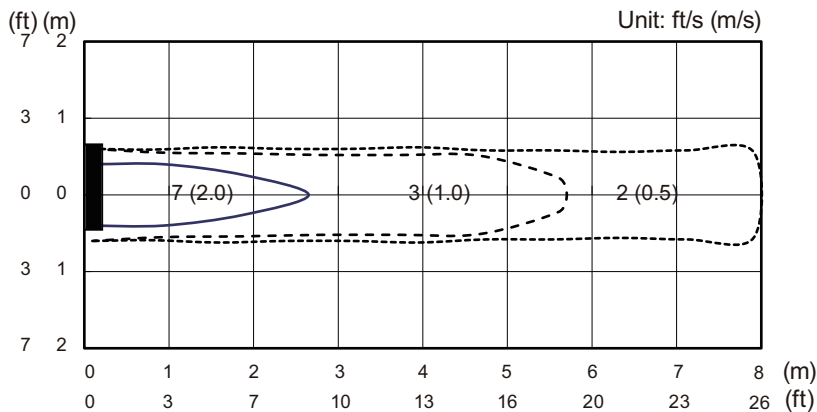

Top view
Vertical airflow direction louver: Up
Horizontal airflow direction louver: Left & Right

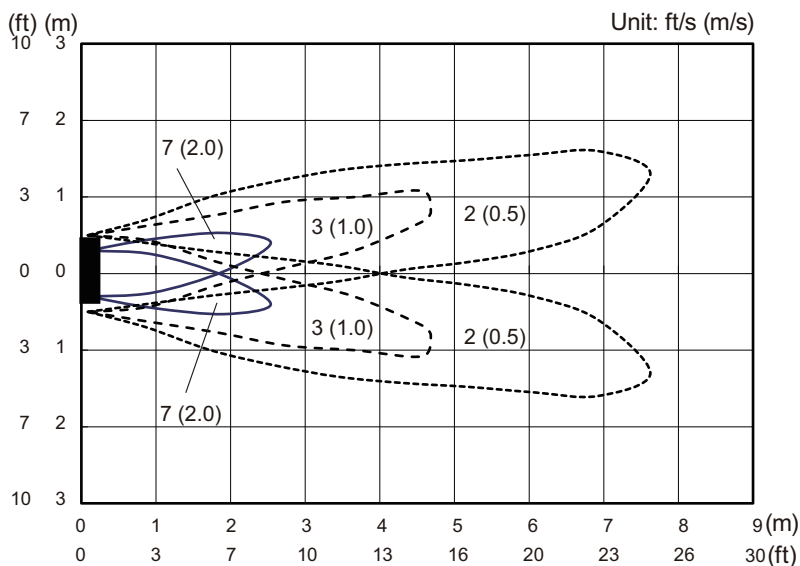

Side view
Vertical airflow direction louver: Up
Horizontal airflow direction louver: Center

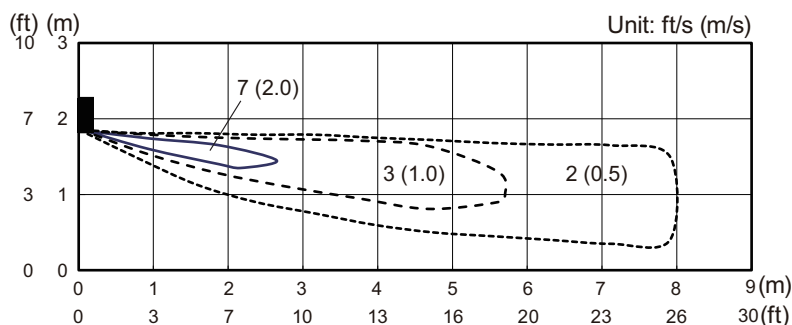

Side view
Vertical airflow direction louver: Down
Horizontal airflow direction louver: Center

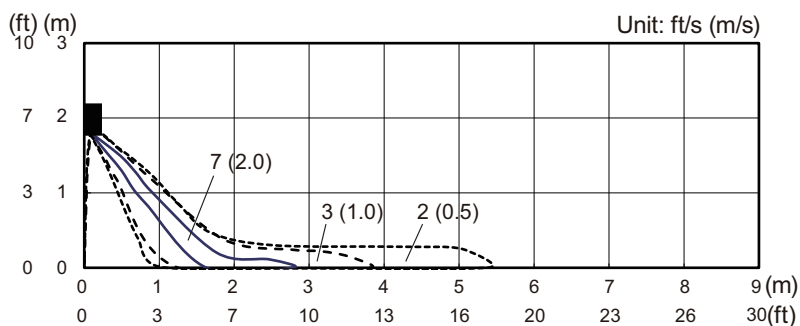

Model: ASUH24LPAS

WALL MOUNTED ASUH18-24LPAS

WALL MOUNTED ASUH18-24LPAS

Measuring conditions	Fan speed	Operation mode
	HIGH	FAN

Top view
Vertical airflow direction louver: Up
Horizontal airflow direction louver: Center

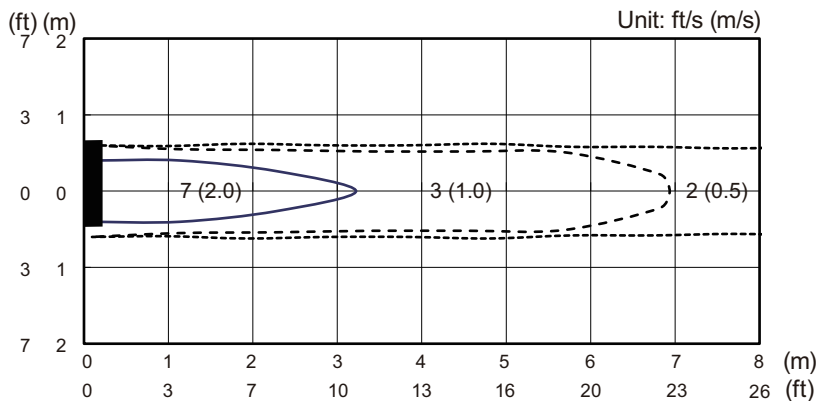

Top view
Vertical airflow direction louver: Up
Horizontal airflow direction louver: Left & Right

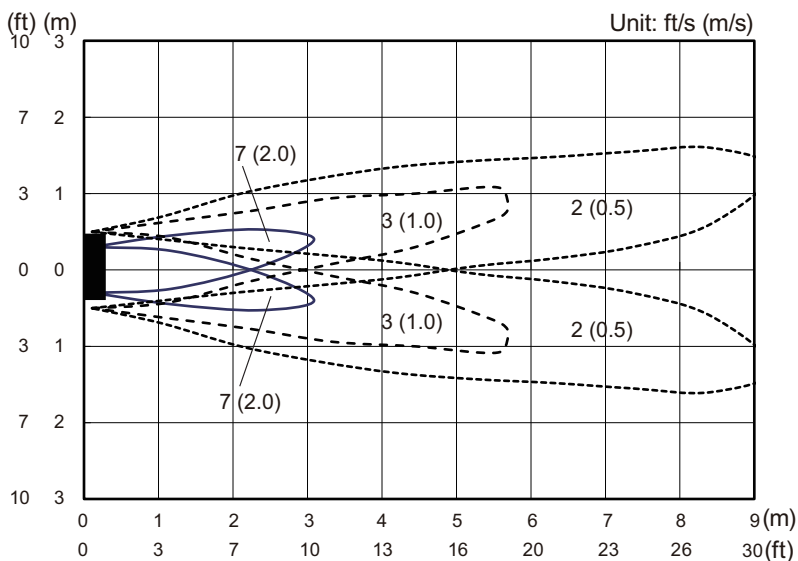

Side view
Vertical airflow direction louver: Up
Horizontal airflow direction louver: Center

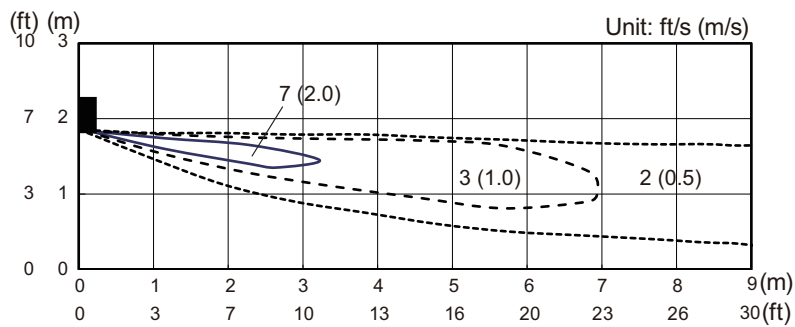

Side view
Vertical airflow direction louver: Down
Horizontal airflow direction louver: Center

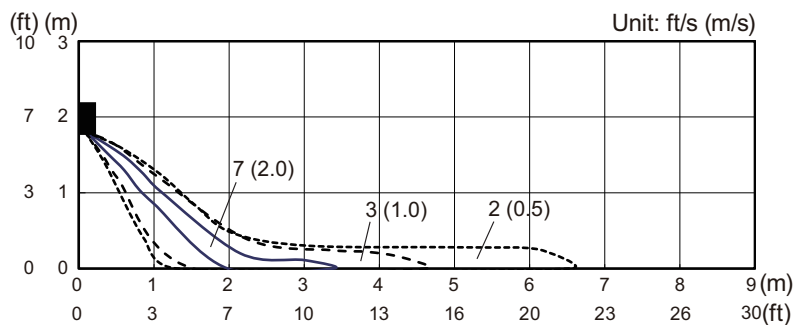

5-2. Airflow

■ Model: ASUH18LPAS

● Cooling

Fan speed	Airflow	
HIGH	m ³ /h	900
	l/s	250
	CFM	530
MED	m ³ /h	800
	l/s	222
	CFM	471
LOW	m ³ /h	640
	l/s	178
	CFM	377
QUIET	m ³ /h	410
	l/s	114
	CFM	241

● Heating

Fan speed	Airflow	
HIGH	m ³ /h	860
	l/s	239
	CFM	506
MED	m ³ /h	690
	l/s	192
	CFM	406
LOW	m ³ /h	560
	l/s	156
	CFM	330
QUIET	m ³ /h	420
	l/s	117
	CFM	247

■ Model: ASUH24LPAS

● Cooling

Fan speed	Airflow	
HIGH	m ³ /h	1,090
	l/s	303
	CFM	642
MED	m ³ /h	800
	l/s	222
	CFM	471
LOW	m ³ /h	640
	l/s	178
	CFM	377
QUIET	m ³ /h	520
	l/s	144
	CFM	306

● Heating

Fan speed	Airflow	
HIGH	m ³ /h	1,010
	l/s	281
	CFM	594
MED	m ³ /h	860
	l/s	239
	CFM	506
LOW	m ³ /h	640
	l/s	178
	CFM	377
QUIET	m ³ /h	520
	l/s	144
	CFM	306

6. Operation noise (sound pressure)

6-1. Noise level curve

Model: ASUH18LPAS

● Cooling

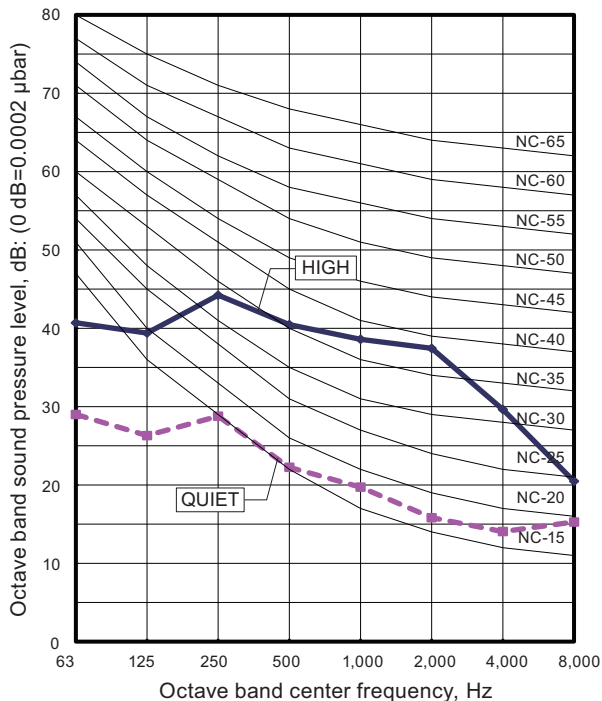

● Heating

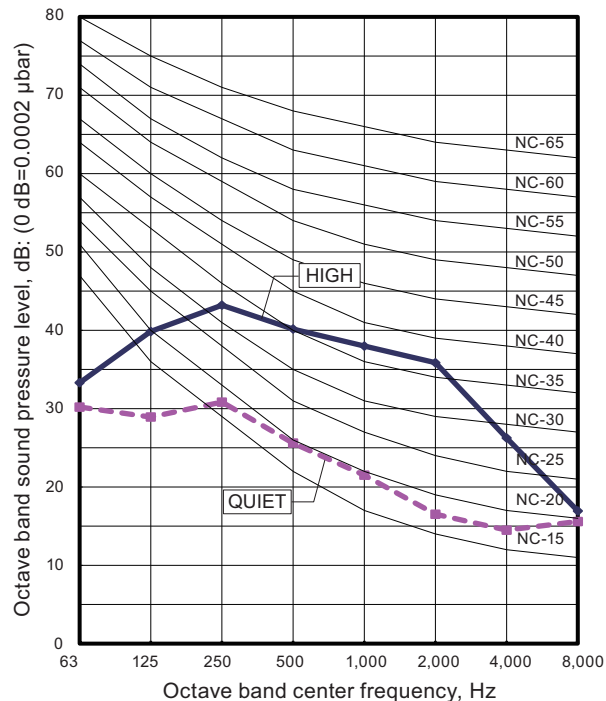

Model: ASUH24LPAS

● Cooling

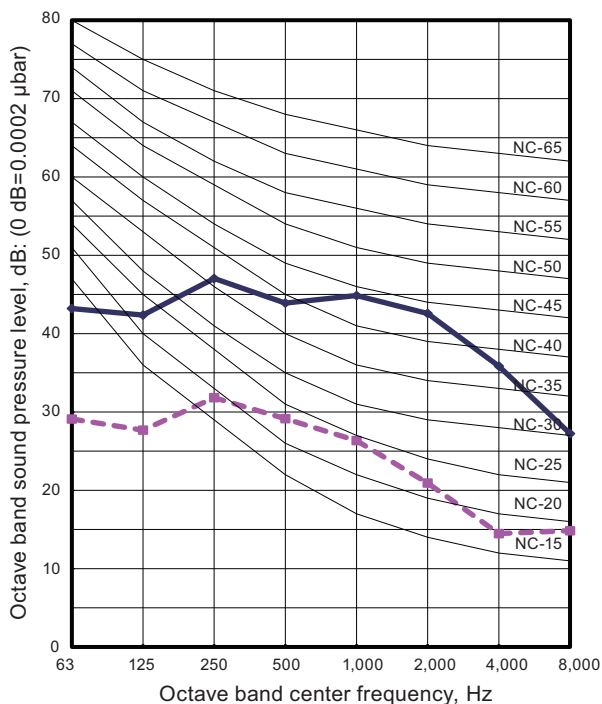

● Heating

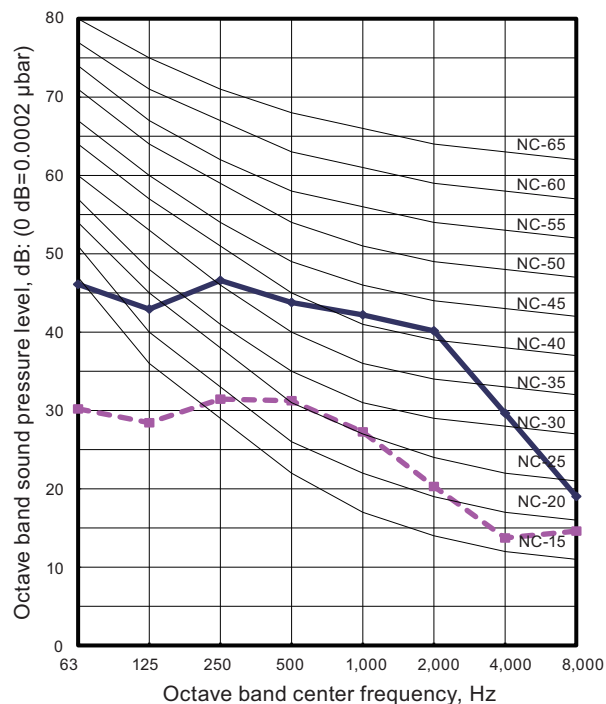

6-2. Sound level check point

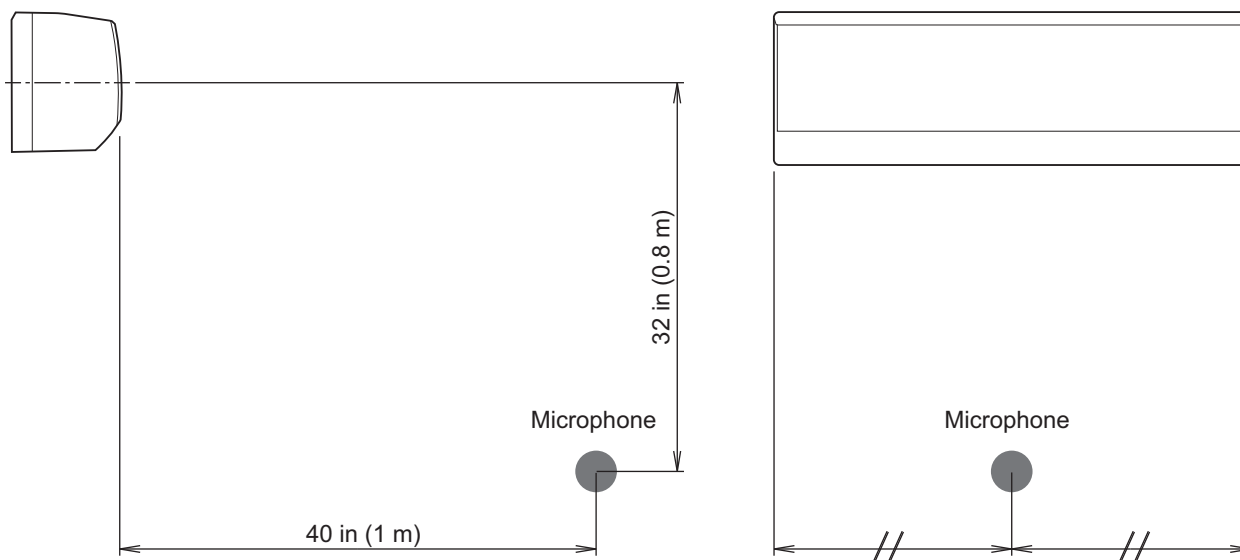

NOTE: Detailed shape of the actual indoor unit might be slightly different from the one illustrated above.

7. Safety devices

Type of protection	Protection form		Model	
			ASUH18LPAS	ASUH24LPAS
Circuit protection	Current fuse (PCB*)		250 V, 3.15 A	
Fan motor protection	Thermal protector program	Activate	257±18 °F (125±10 °C) Fan motor stop	
		Reset	212±18 °F (100±10 °C) Fan motor restart	

*PCB: Printed Circuit Board

8. External input and output

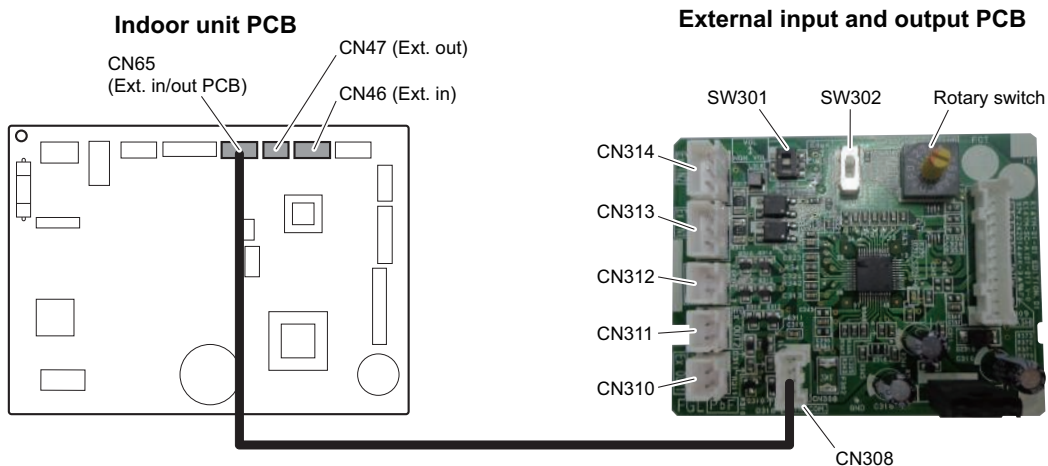

PCB	External input	External output	Connector	Input select	Input signal
Indoor unit	Operation/Stop	-	CN46	Dry contact	Edge
	Forced stop				
	-	Operation status	CN47	-	-
		Error status			
		Indoor unit fan operation status			
		Cooling thermostat On			
-	Heating thermostat On	-	-	-	
	External heater output				
External input and output (UTY-XCSXZ2)	Operation/Stop	-	CN313/ CN314	Dry contact/ Apply voltage	Edge/Pulse
	Forced stop		CN313		Edge
	Forced thermostat off			CN310/ CN311/ CN312	-
	-	Operation status			
		Error status			
		Indoor unit fan operation status			
		External heater output			
	-	Remote controller output	-	-	-
Cooling high/low output					
-	Heating thermostat On	-	-	-	

8-1. External input

With using external input function, some functions on this product can be controlled from an external device.

- "Operation/Stop" mode or "Forced stop" mode can be selected with function setting of indoor unit.
- A twisted pair cable (22AWG) should be used. Maximum length of cable is 492 ft (150 m).
- The wire connection should be separate from the power cable line.

■ Indoor unit

Indoor unit functions such as Operation/Stop can be done by using indoor unit connectors.

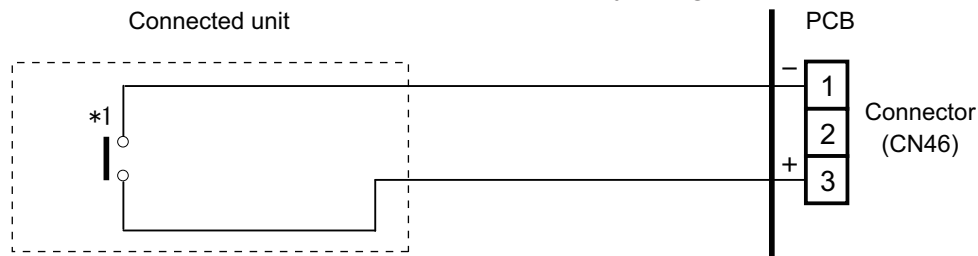

*1: The switch can be used on the following condition: DC 12 V to 24 V, 1 mA to 15 mA.

External input and output PCB

The indoor unit Operation/Stop can be set by using the input connector on the PCB.

• Input select:

Use either one of these types of connectors according to the application. (Both types of connectors cannot be used simultaneously.)

– Dry contact

In case of internal power supply, set the slide switch of SW301 to "NON VOL" side.

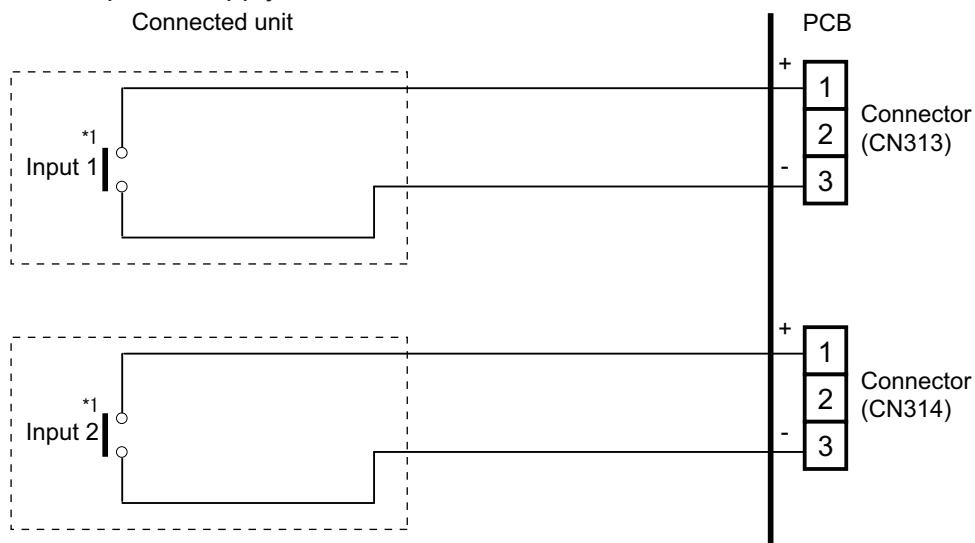

*1: The switches can be used on the following condition: DC 12 V to 24 V, 1 mA to 15 mA.

– Apply voltage

In case of external power supply, set the slide switch of SW301 to "VOL" side.

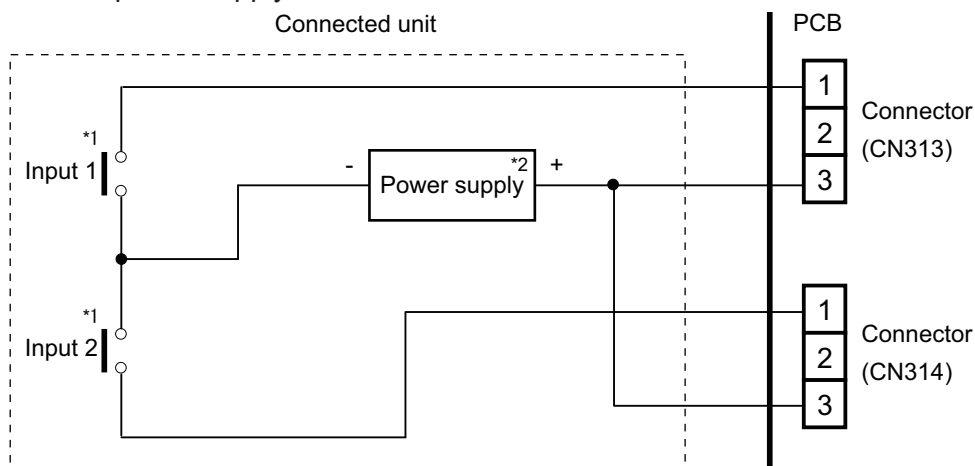

*1: The switches can be used on the following condition: DC 12 V to 24 V, 1 mA to 15 mA.

*2: Make the power supply DC 12 to 24 V, 10 mA or more.

8-2. External output

Use an external output cable with appropriate external dimension, depending on the number of cables to be installed.

Indoor unit

- A twisted pair cable (22AWG) should be used. Maximum length of cable is 82 ft (25 m).
- Output voltage: High DC 12 V \pm 2 V, Low 0 V.
- Permissible current: 50 mA
- For details, refer to ["Combination of external input and output"](#) on page 22.

When indicator or other components are connected directly

Example: Function setting 60 is set to "00"

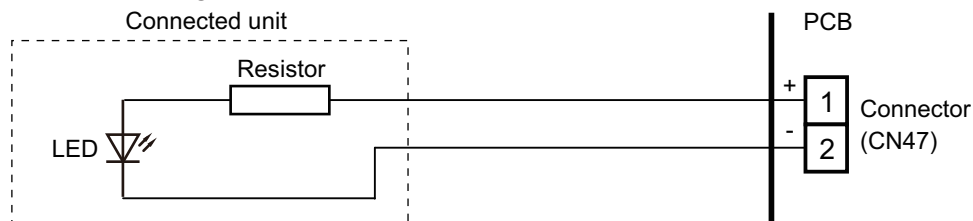

When connecting with a device equipped with a power supply

Example: Function setting 60 is set to "00"

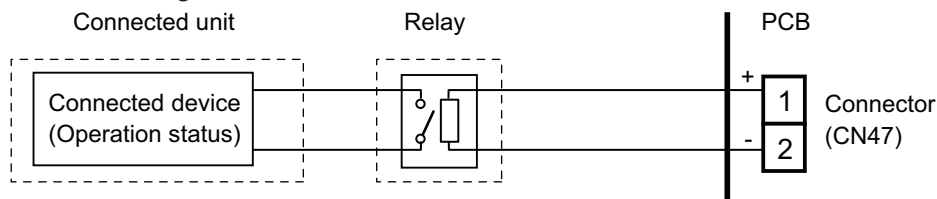

External input and output PCB

- A twisted pair cable (22AWG) should be used. Maximum length of cable is 82 ft (25 m).
 - Output voltage: High DC 12 V±2 V, Low 0 V.
 - Permissible current: 50 mA
 - For details, refer to "[Combination of external input and output](#)" on page 22.
- **When indicator or other components are connected directly:**
Example: Rotary SW on External input and output PCB is set to "1".

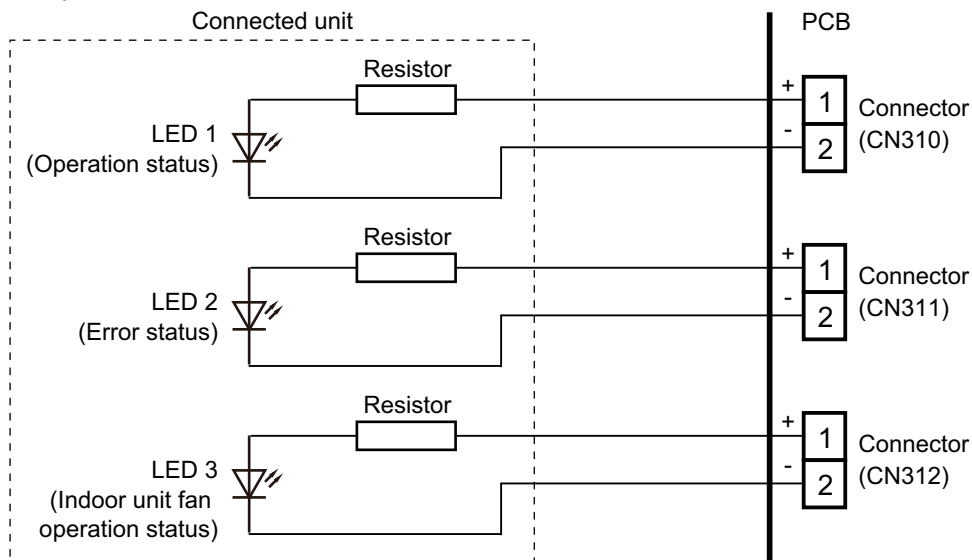

- **When connecting with a device equipped with a power supply:**
Example: Rotary SW on External input and output PCB is set to "1".

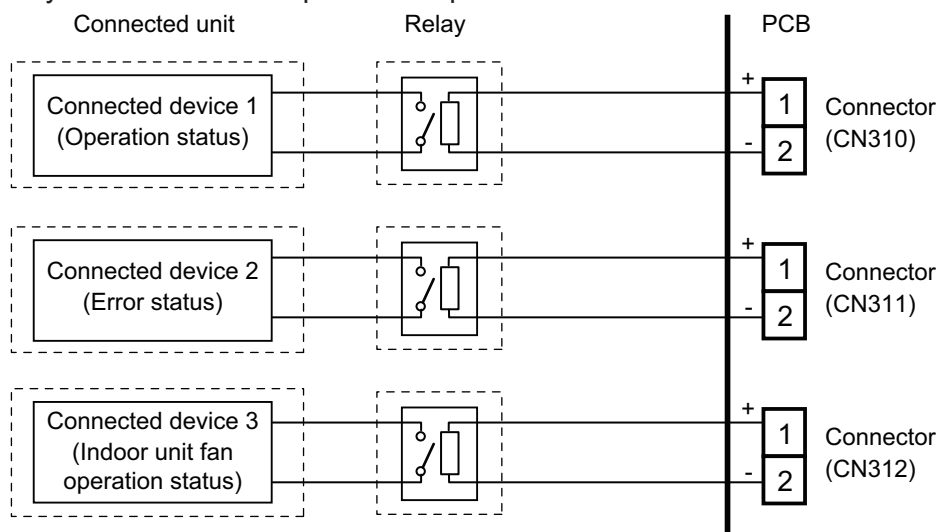

8-3. Combination of external input and output

By combining the function setting of the indoor unit and rotary switch setting of the External input and output PCB, you can select various combinations of functions.

Combination examples of external input and output are as follows:

Mode	Function setting	Rotary SW	External input		
			Indoor unit	External input and output PCB	
			CN46	1 CN313	2 CN314
0-1	60—00	1	Operation/Stop (Function setting 46-00) or Forced stop (Function setting 46-02)	Operation/Stop	Not available
0-2	60-00	2		Operation	Stop
1	60-01	3		Forced thermostat Off	Not available
2	60-02	4		Mechanical cooling Off	
3	60-03	5		Forced thermostat Off	
4	60-04	6		Mechanical cooling On	
5	60-05	7		Mechanical cooling On	
6	60-06	8		Forced thermostat Off	
7	60-07	9		Forced thermostat Off	
8	60-08	A		Mechanical cooling Off	
9	60-09	B		Forced thermostat Off	
10	60-10	C	Forced thermostat Off		
11	60-11	D	Forced thermostat Off		

Mode	Function setting	Rotary SW	External output			
			Indoor unit	External input and output PCB		
			CN47	1 CN310	2 CN311	3 CN312
0-1	60-00	1	Operation/Stop	Operation/Stop	Error status	Indoor unit fan operation status
0-2	60-00	2	Operation/Stop	Error status	Indoor unit fan operation status	External heater output
1	60-01	3	Cooling thermostat On	Error status	Indoor unit fan operation status	External heater output
2	60-02	4	Cooling thermostat On	Error status	Remote controller output	External heater output
3	60-03	5	Cooling thermostat On	Cooling high/low output	Remote controller output	External heater output
4	60-04	6	Cooling thermostat On	Error status	Remote controller output	Cooling high/low output
5	60-05	7	Heating thermostat On	Error status	Indoor unit fan operation status	External heater output
6	60-06	8	Operation/Stop	Error status	Indoor unit fan operation status	Heating thermostat On
7	60-07	9	Cooling thermostat On	Error status	Heating thermostat On	External heater output
8	60-08	A	Cooling thermostat On	Heating thermostat On	Remote controller output	External heater output
9	60-09	B	Error status	Operation/Stop	Indoor unit fan operation status	External heater output
10	60-10	C	Indoor unit fan operation status	Operation/Stop	Error status	External heater output

Mode	Function setting	Rotary SW	External output			
			Indoor unit	External input and output PCB		
			CN47	1 CN310	2 CN311	3 CN312
11	60-11	D	External heater output	Operation/Stop	Indoor unit fan operation status	Error status

NOTE: Input of Operation/Stop depends on the setting of function setting 46.

- 00: Operation/Stop mode 1 (R.C. enabled)
- 01: (Setting prohibited)
- 02: Forced stop
- 03: Operation/Stop mode 2 (R.C. disabled)

Input signal type

External input and output PCB:

The input signal type can be selected.

Signal type (edge or pulse) can be switched by the DIP switch SW302 on the External input and output PCB.

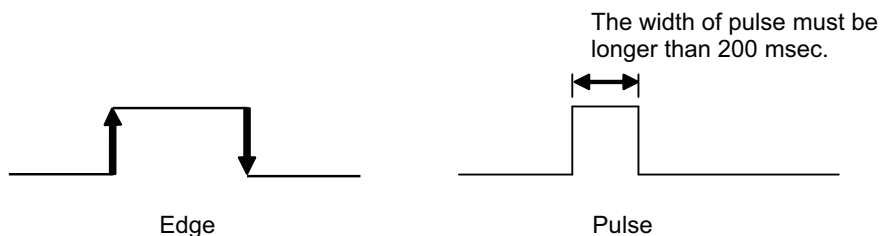

8-4. Details of function

■ Control input function

- When function setting is “Operation/Stop” mode 1
 - In the case of “Edge” input:

Function setting	Rotary SW on External input and output PCB	External input		Input signal	Command
		External input and output PCB	CN313		
46-00	1			Off → On	Operation
				On → Off	Stop

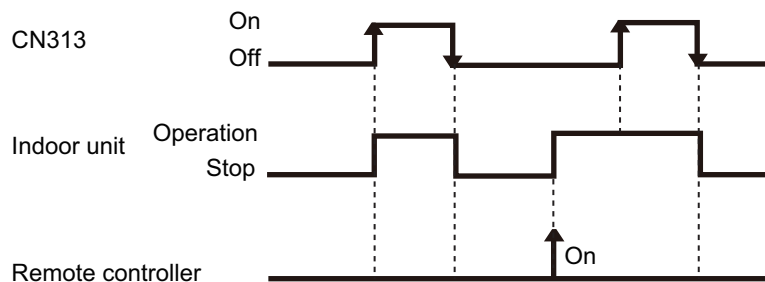

- In the case of “Pulse” input:

Function setting	Rotary SW on External input and output PCB	External input		Input signal	Command
		External input and output PCB	CN313		
46-00	1		CN313	Pulse	Operation
			CN314	Pulse	Stop

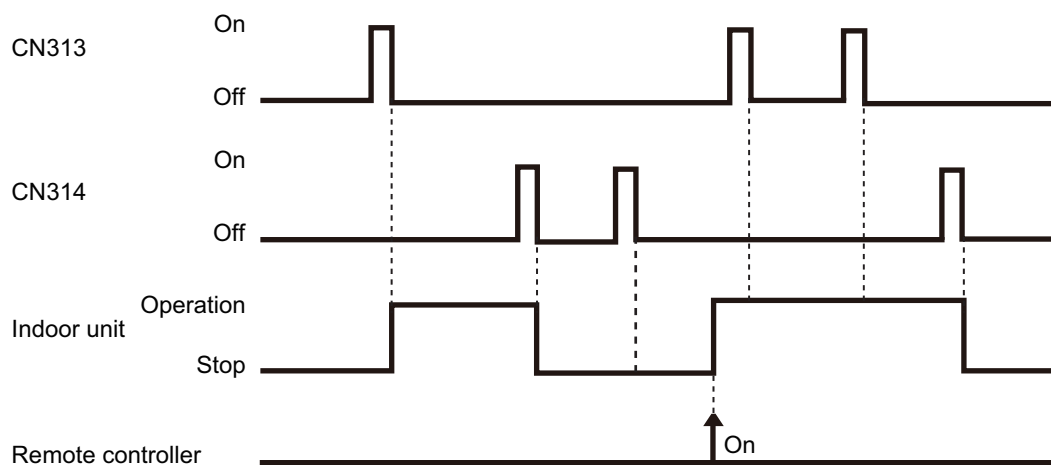

NOTES:

- The last command has priority.
- The indoor units within the same remote controller group operates in the same mode.

• When function setting is “Forced stop” mode

– In the case of “Edge” input:

Function setting	Rotary SW on External input and output PCB	External input		Input signal	Command
		External input and output PCB	CN313		
46-02	1			Off → On	Forced stop
				On → Off	Normal

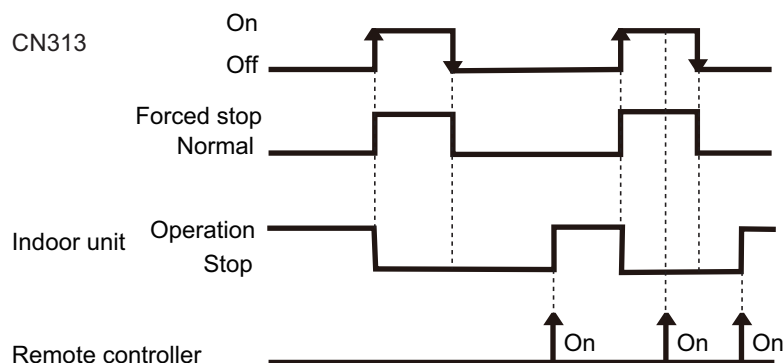

– In the case of “Pulse” input:

Function setting	Rotary SW on External input and output PCB	External input		Input signal	Command
		External input and output PCB	CN313 CN314		
46-02	1		CN313	Pulse	Forced stop
			CN314	Pulse	Normal

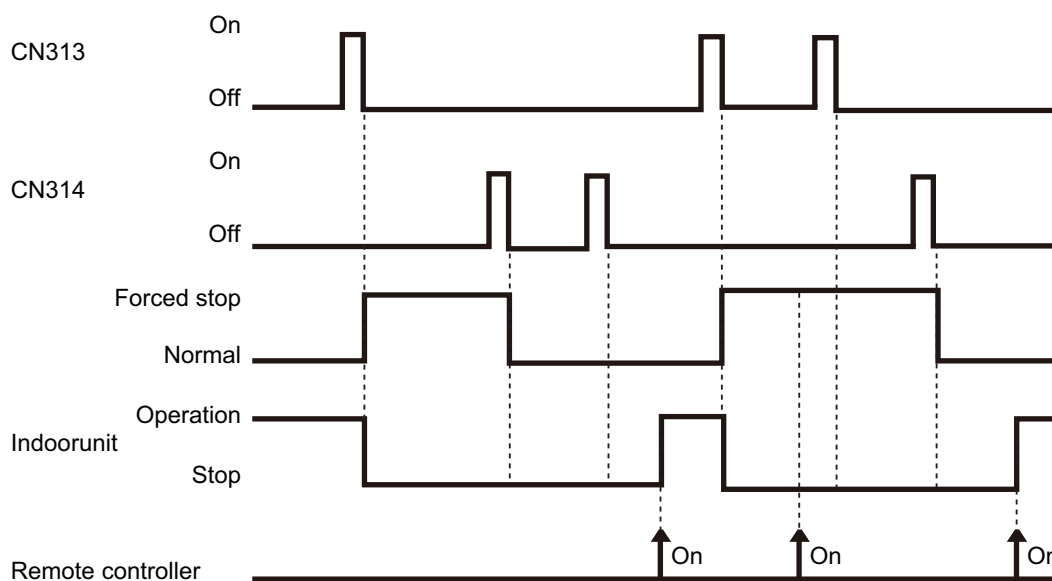

NOTES:

- When the forced stop is triggered, indoor unit stops and Operation/Stop operation by the remote controller is restricted.
- When forced stop function is used with forming a remote controller group, connect the same equipment to each indoor unit within the group.

• When function setting is “Operation/Stop” mode 2

– In the case of “Edge” input:

Function setting	Rotary SW on External input and output PCB	External input		Input signal	Command
46-03	1	External input and output PCB	CN313	Off → On	Operation
				On → Off	Stop (R.C. disabled)

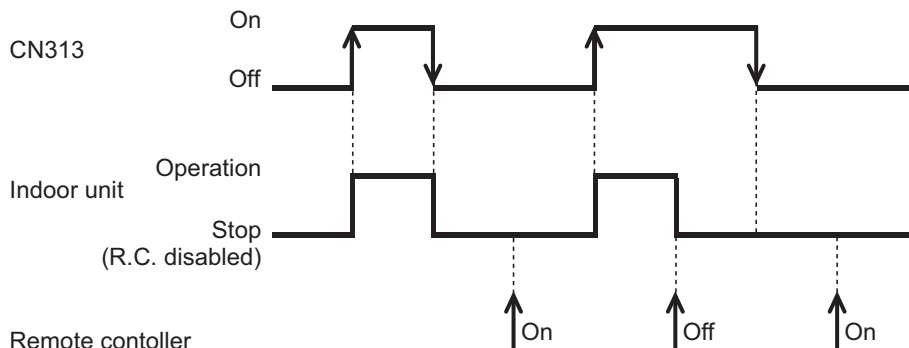

– In the case of “Pulse” input:

Function setting	Rotary SW on External input and output PCB	External input		Input signal	Command
46-03	1	External input and output PCB	CN313	Pulse	Operation
			CN314	Pulse	Stop (R.C. disabled)

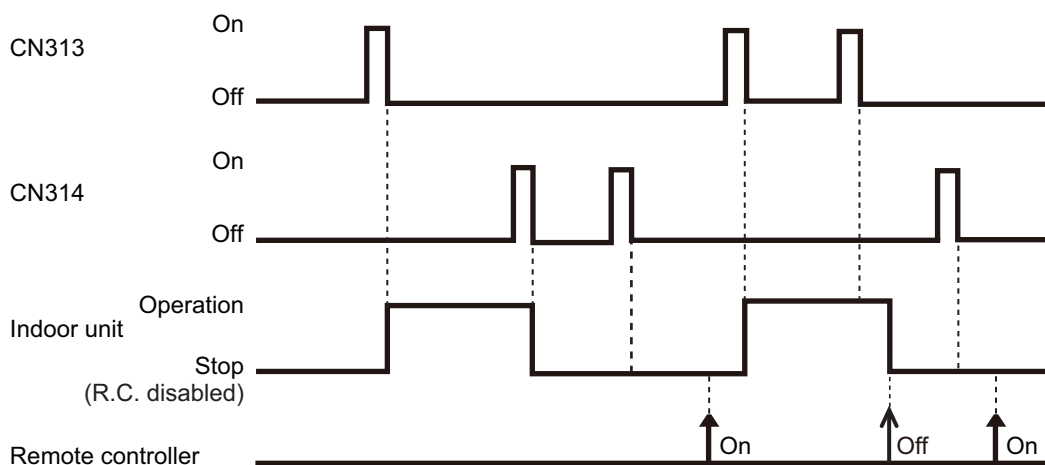

NOTE: When “Operation/Stop” mode 2 function is used with forming a remote controller group, connect the same equipment to each indoor unit within the group.

• Forced thermostat off function

Rotary SW on External input and output PCB	External input		Input signal	Command
2 B C	External input and output PCB	CN313	Off → On	Thermostat off
On → Off			Normal operation	

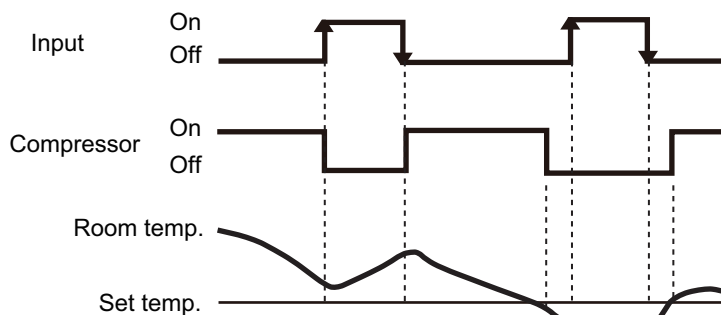

■ Control output function

• Operation/Stop status

Rotary SW on External input and output PCB	External output		Output signal	Command
1 B C D	External input and output PCB	CN310	Off → On	Operation
On → Off			Stop	

The output is low when the unit is stopped.

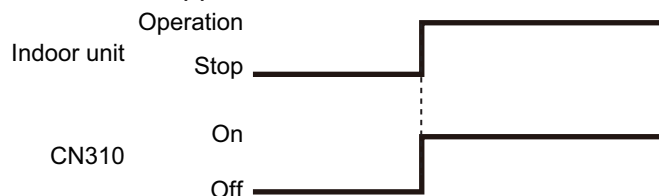

• Error status

Rotary SW on External input and output PCB	External output		Output signal	Command
1 C	External input and output PCB	CN311	Off → On	Error
			On → Off	Normal
D		CN312	Off → On	Error
			On → Off	Normal

The output is ON when an error is generated for the indoor unit.

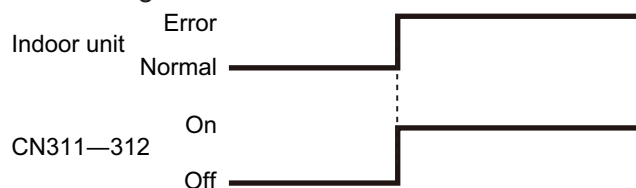

- Indoor unit fan operation status

Rotary SW on External input and output PCB	External output		Output signal	Command
1	External input and output PCB	CN312	Off → On	Fan run
2 B D			CN311	On → Off
		Off → On		Fan run
On → Off		Fan stop		

Output signal	Condition
On Low → High	The indoor unit fan is operating.
Off High → Low	The fan is stopped or during cold air prevention. During thermostat off when in dry mode operation.

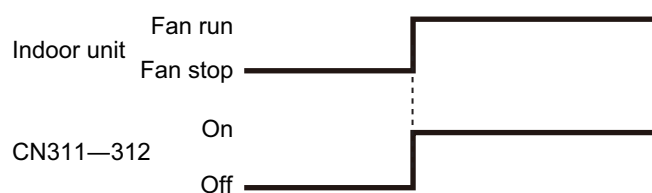

- External heater output

Rotary SW on External input and output PCB	External output		Output signal	Command
2 B C	External input and output PCB	CN312	Off → On	Heater on
On → Off			Heater off	

External heater output

Control	Primary heater	Auxiliary heater	Function setting	
			Indoor unit	Wired R. C.
			Control switching external heaters No. 61	Sensor activation*2
Auxiliary heater control 1	Heat pump	External device*1	61-00	—
Auxiliary heater control 2	Heat pump	External device	61-01	—
Heat pump prohibition control	External device	None	61-02	On (Enabled)
Auxiliary heater control by outdoor temperature 1	Heat pump	External device	61-03	On (Enabled)
Auxiliary heater control by outdoor temperature 2	Heat Pump	External device	61-04	On (Enabled)
Auxiliary heater control by outdoor temperature 3	Heat Pump	External device	61-05	On (Enabled)
Auxiliary heat pump control	External device	Heat pump	61-06	On (Enabled)
Auxiliary heat pump control by outdoor temperature 1	External device	Heat pump	61-07	On (Enabled)
Auxiliary heat pump control by outdoor temperature 2	External device	Heat pump	61-08	On (Enabled)
Auxiliary heat pump control by outdoor temperature 3	External device	Heat pump	61-09	On (Enabled)

NOTES:

- After turning off the heater, 3 minutes of standby time is required by next power-on of the heater.
- For items marked “—” in the table, any of validate or invalidate of the setting are acceptable.
- *1: External device means Hot water, Electrical heater, etc.
- *2: Sensor activation:
 - Setting change from the factory setting is required.
 - Indoor unit fan setting will be on for safety reason without sensor activation of wired remote controller.

Installation configuration of individual connection

External heating device is installed individually. (No use of indoor unit fan)

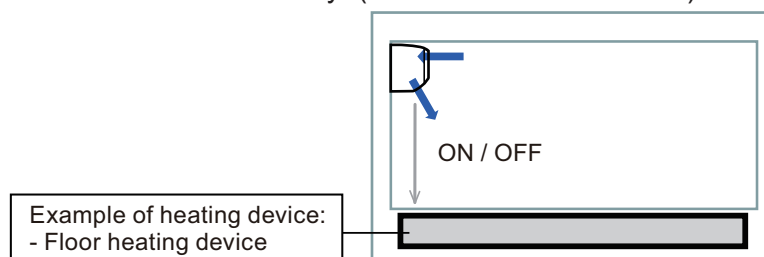

⚠ WARNING

- Design and install external heater appropriately with considering its protection.
- Inappropriate designing and installation of external heater may cause a fire by emitted heat from the external heater.
- Fujitsu General Ltd. is not responsible for inappropriate designing or installation of external heating device.

● Auxiliary heater control 1

Operation	Condition
Heater on	Heater is on as shown in following diagram of heating temperature.
Heater off	<ul style="list-style-type: none"> • Heater is off as shown in following diagram of heating temperature. • Other than heating mode • Error occurred • Forced thermostat off • Fan stop protection

- Temperature of heater on (Thon): Adjustable by function number 62 (Operating temperature switching of external heaters).
- All control temperatures will shift by adjusting "Thon".

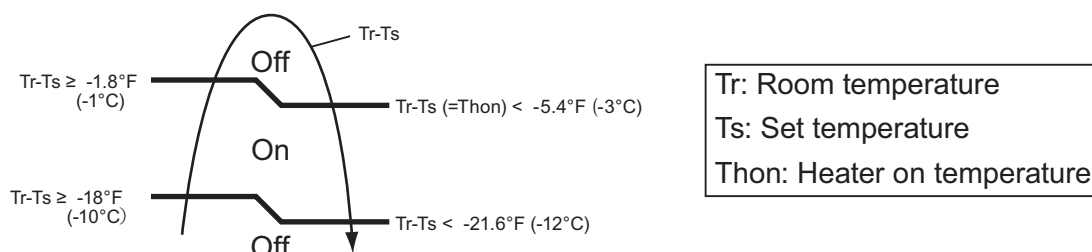

Example: When set temperature (Ts) is 72°F (22°C) (Factory setting),

- and room temperature (Tr) increases above 53.6°F (12°C), signal output is on.
- and room temperature (Tr) increases above 69.8°F (21°C), signal output is off.
- and room temperature (Tr) decreases below 66.2°F (19°C), signal output is on.
- and room temperature (Tr) decreases below 50°F (10°C), signal output is off.

● Auxiliary heater control 2

Operation	Condition
Heater on	Heater is on as shown in following diagram of heating temperature.
Heater off	<ul style="list-style-type: none"> • Heater is off as shown in following diagram of heating temperature. • Other than heating mode • Error occurred • Forced thermostat off • Fan stop protection

- Temperature of heater on (Thon): Adjustable by function number 62 (Operating temperature switching of external heaters).
- All control temperatures will shift by adjusting "Thon".

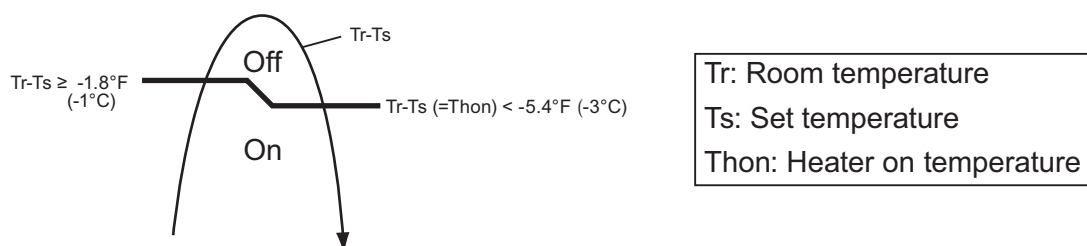

● Heat pump prohibition control

Perform heating by external heater only. Indoor unit is continuous thermostat off.

Operation	Condition
Heater on	Heater is on as shown in following diagram of heating temperature.
Heater off	<ul style="list-style-type: none"> • Heater is off as shown in following diagram of heating temperature. • Other than heating mode • Error occurred • Forced thermostat off

- Temperature of heater on (Thon): Adjustable by function number 62 (Operating temperature switching of external heaters).
- All control temperatures will shift by adjusting “Thon”.

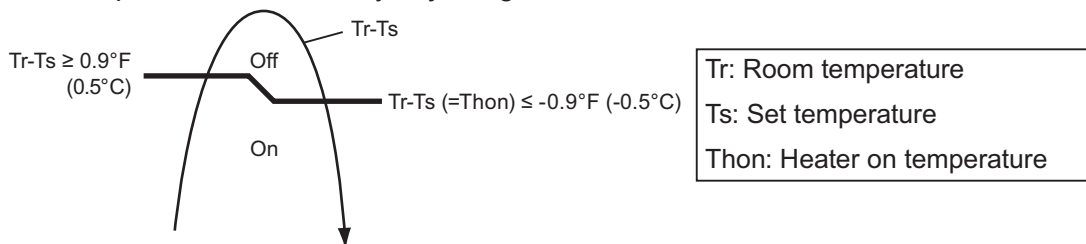

• Operation status

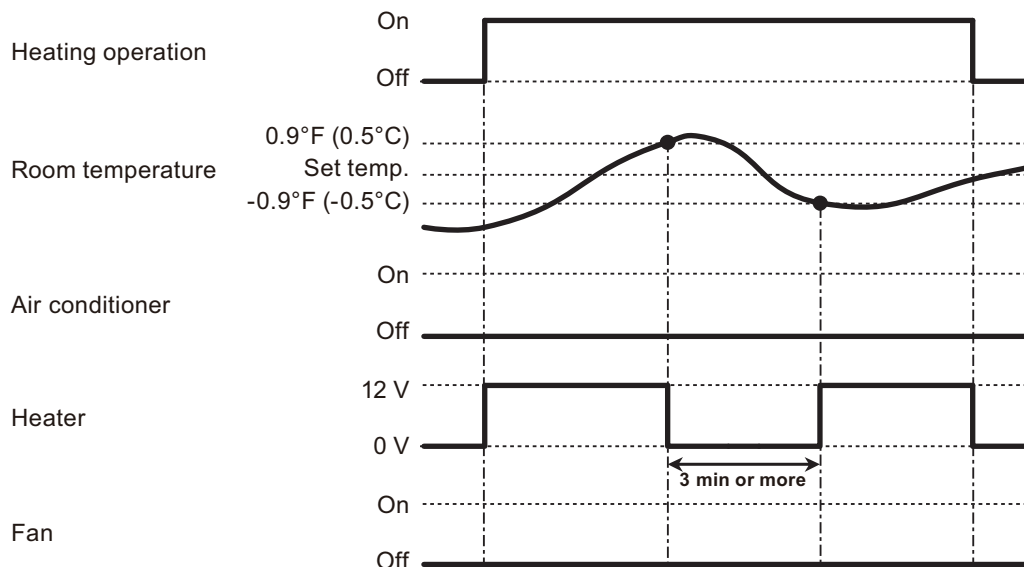

NOTE: In following operations, compressor will be on.

- Other than heating
- Test run

● Auxiliary heater control by outdoor temperature 1

This control selects heat pump or external heater according to the outdoor temperature. When outdoor temperature is high, the heating is performed by using heat pump only.

Operation	Condition
Heater on	Heater is on as shown in following diagram of heating temperature.
Heater off	<ul style="list-style-type: none"> • Heater is off as shown in following diagram of heating temperature. • Other than heating mode • Error occurred • Forced thermostat off • Heat pump only zone

- Temperature of heater on (Thon): Adjustable by function number 62 (Operating temperature switching of external heaters).
- All control temperatures will shift by adjusting "Thon".
- Outdoor temperature zone boundary A and B: Adjustable individually by function setting number 66 and 67.

• External heater output

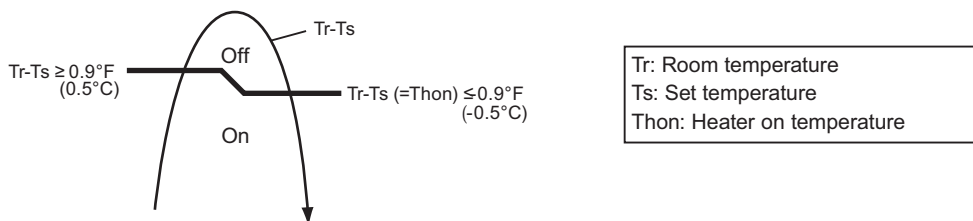

• Outdoor temperature zone

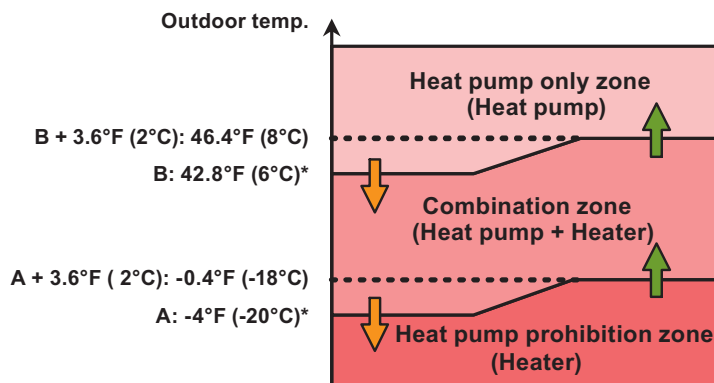

*: Adjustable by function setting 66 and 67

• Operation status

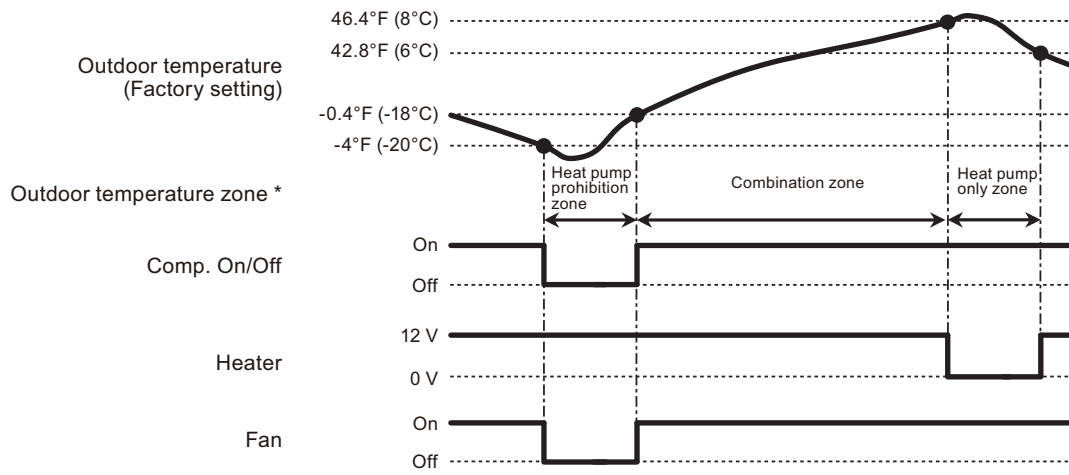

* The outdoor temperature zone transition from one to another will stay in that zone for minimum of 30 min.

NOTE: In following operations, compressor will be on in heat pump prohibition zone.

- Other than heating
- Test run

● Auxiliary heater control by outdoor temperature 2

This control selects heat pump or external heater according to the outdoor temperature. Even when outdoor temperature is high, the heating is performed by using both of heat pump and external heater.

Operation	Condition
Heater on	Heater is on as shown in following diagram of heating temperature.
Heater off	<ul style="list-style-type: none"> • Heater is off as shown in following diagram of heating temperature. • Other than heating mode • Error occurred • Forced thermostat off

- Temperature of heater on (Thon): Adjustable by function number 62 (Operating temperature switching of external heaters).
- All control temperatures will shift by adjusting “Thon”.
- Outdoor temperature zone boundary A: Adjustable by function setting number 66.

• External heater output

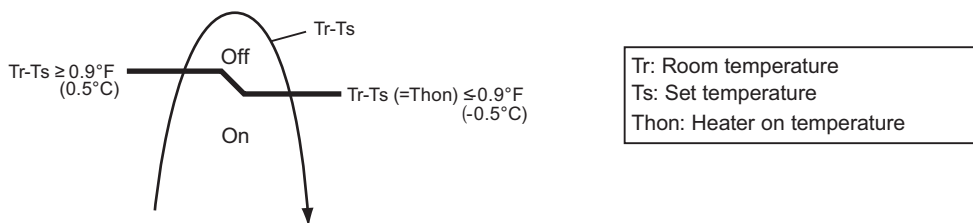

• Outdoor temperature zone

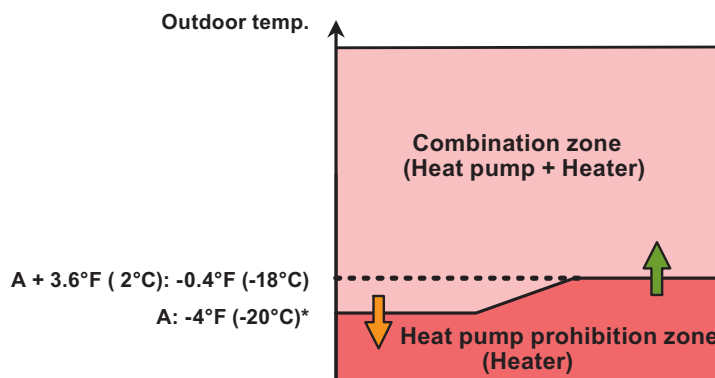

*: Adjustable by function setting 66

• Operation status

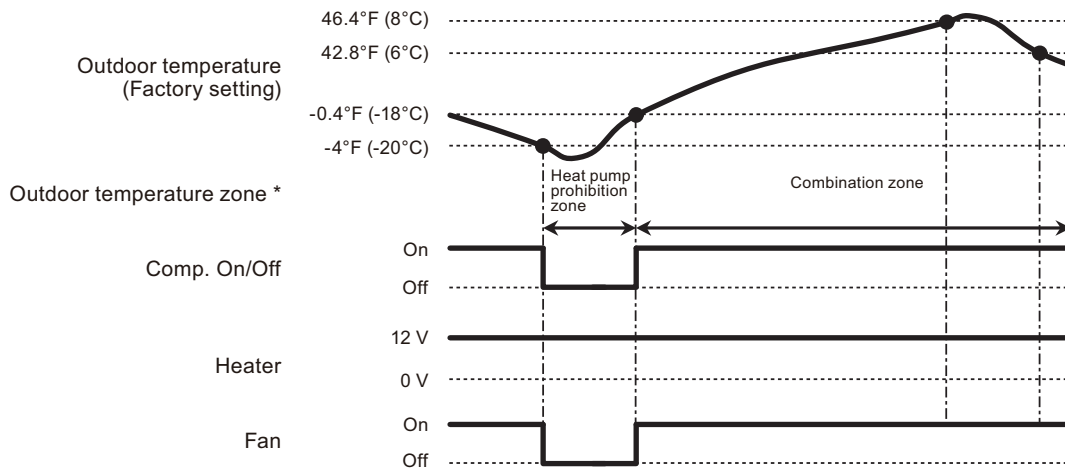

* The outdoor temperature zone transition from one to another will stay in that zone for minimum of 30 min.

NOTE: In following operations, compressor will be on in heat pump prohibition zone.

- Other than heating
- Test run

● Auxiliary heater control by outdoor temperature 3

This control selects heat pump or external heater according to the outdoor temperature. Even when outdoor temperature is high, the heating is performed by using both of heat pump and external heater.

Operation	Condition
Heater on	Heater is on as shown in following diagram of heating temperature.
Heater off	<ul style="list-style-type: none"> • Heater is off as shown in following diagram of heating temperature. • Other than heating mode • Error occurred • Forced thermostat off

- Temperature of heater on (Thon): Adjustable by function number 62 (Operating temperature switching of external heaters).
- All control temperatures will shift by adjusting “Thon”.
- Outdoor temperature zone boundary B: Adjustable by function setting number 67.

• External heater output

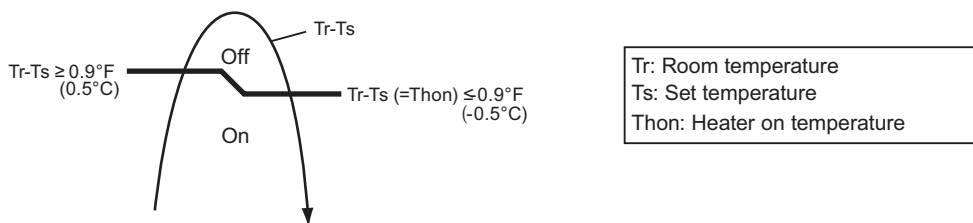

• Outdoor temperature zone

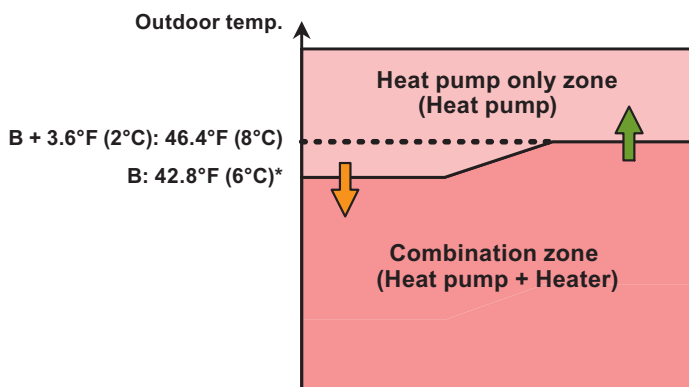

*: Adjustable by function setting 67

• Operation status

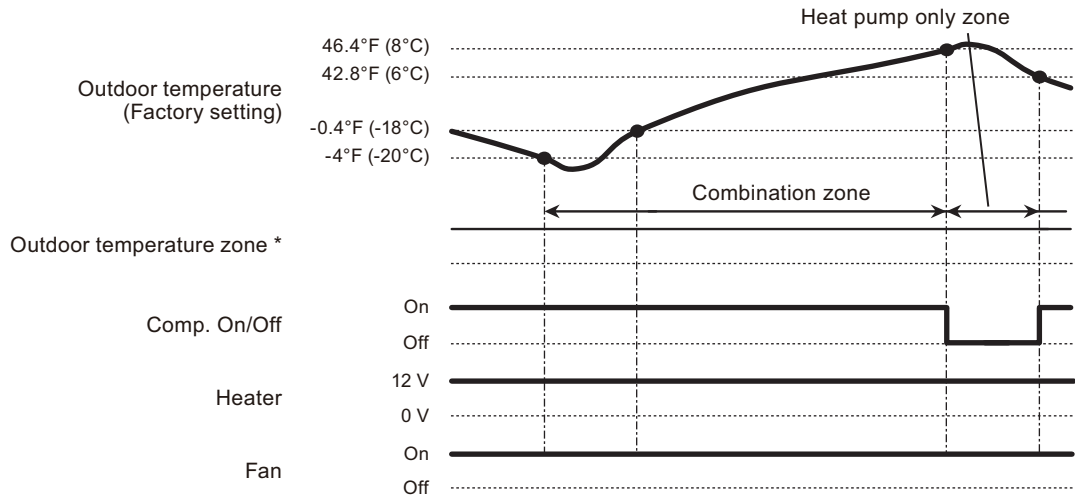

* The outdoor temperature zone transition from one to another will stay in that zone for minimum of 30 min.

NOTE: In following operations, compressor will be on in heat pump prohibition zone.

- Other than heating
- Test run

● Auxiliary heat pump control

• External heater output

Operation	Condition
Heater on	Heater is on as shown in following diagram of heating temperature.
Heater off	<ul style="list-style-type: none"> • Heater is off as shown in following diagram of heating temperature. • Other than heating mode • Error occurred • Forced thermostat off

- Temperature of heater on (Thon): Set temperature (Ts) - 0.9 °F (- 0.5 °C)
- Temperature of heater off: Set temperature (Ts) + 0.9 °F (+ 0.5 °C)

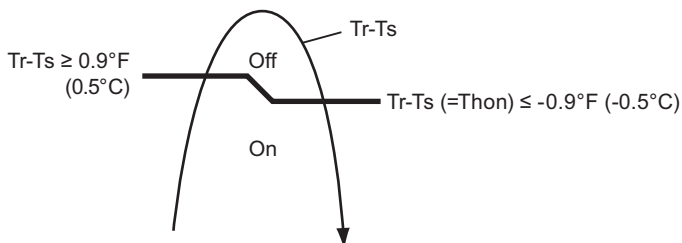

Tr: Room temperature
Ts: Set temperature
Thon: Heater on temperature

• Auxiliary heat pump On/Off

- Temperature of heater on (Thon): Adjustable by function number 62 (Operating temperature switching of heat pump).
- All control temperatures will shift by adjusting “Thon”.

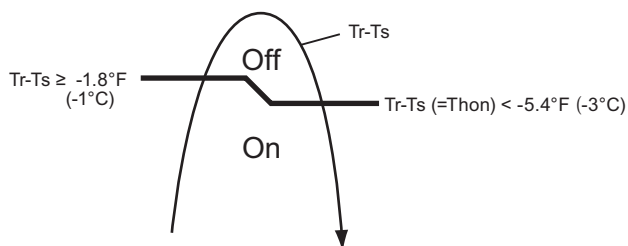

Tr: Room temperature
Ts: Set temperature
Thon: Heater on temperature

● Auxiliary heat pump control by outdoor temperature 1

• External heater output

Operation	Condition
Heater on	Heater is on as shown in following diagram of heating temperature.
Heater off	<ul style="list-style-type: none"> • Heater is off as shown in following diagram of heating temperature. • Other than heating mode • Error occurred • Forced thermostat off

- Temperature of heater on (Thon): Set temperature (Ts) - 0.9 °F (- 0.5 °C)
- Temperature of heater off: Set temperature (Ts) + 0.9 °F (+ 0.5 °C)

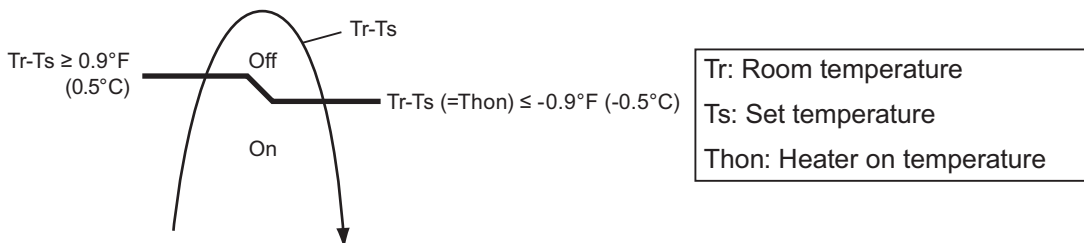

• Auxiliary heat pump On/Off

- Temperature of heater on (Thon): Adjustable by function number 62 (Operating temperature switching of heat pump).
- All control temperatures will shift by adjusting “Thon”.

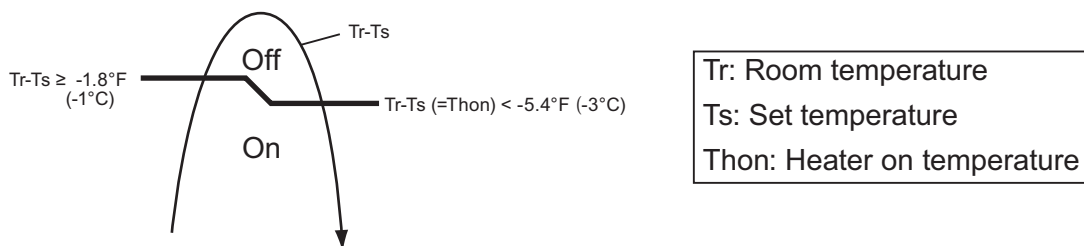

• Outdoor temperature zone

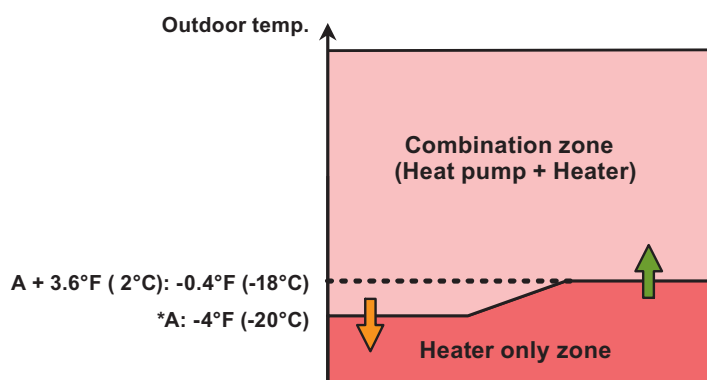

*: Adjustable by function setting 66

• **Operation status**

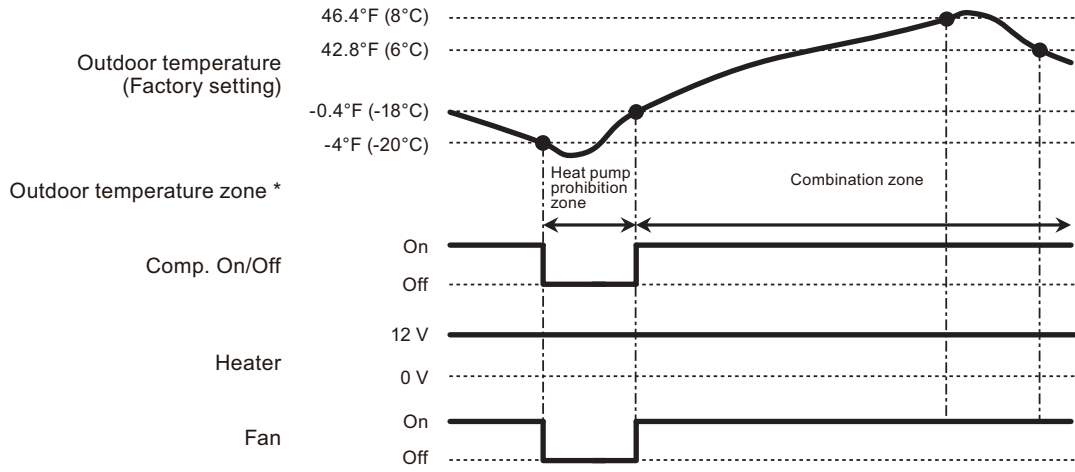

* The outdoor temperature zone transition from one to another will stay in that zone for minimum of 30 min.

NOTE: In following operations, compressor will be on in heat pump prohibition zone.

- Other than heating
- Test run

● Auxiliary heat pump control by outdoor temperature 2

• External heater output

Operation	Condition
Heater on	Heater is on as shown in following diagram of heating temperature.
Heater off	<ul style="list-style-type: none"> • Heater is off as shown in following diagram of heating temperature. • Other than heating mode • Error occurred • Forced thermostat off

- Temperature of heater on (Thon): Set temperature (Ts) - 0.9 °F (- 0.5 °C)
- Temperature of heater off: Set temperature (Ts) + 0.9 °F (+ 0.5 °C)

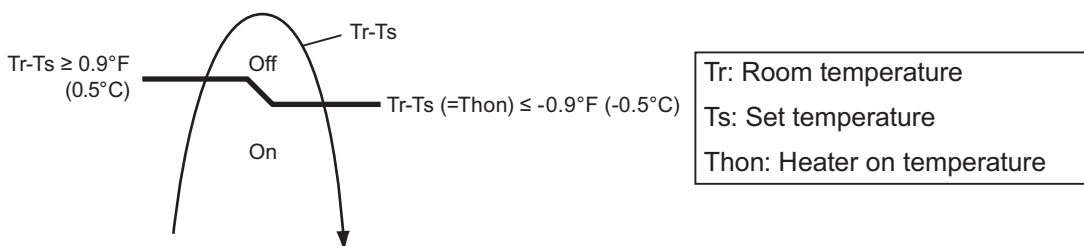

• Auxiliary heat pump On/Off

- Temperature of heater on (Thon): Adjustable by function number 62 (Operating temperature switching of heat pump).
- All control temperatures will shift by adjusting “Thon”.

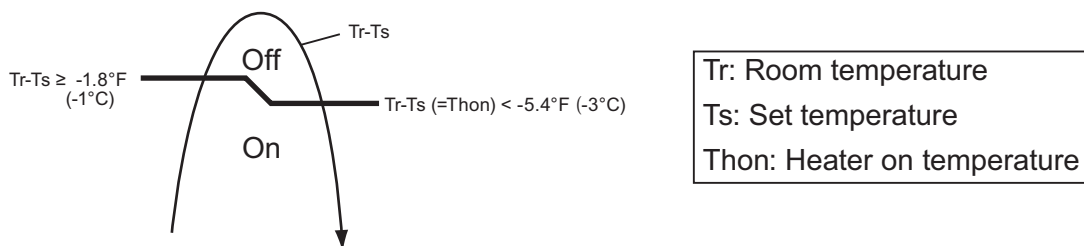

• Outdoor temperature zone

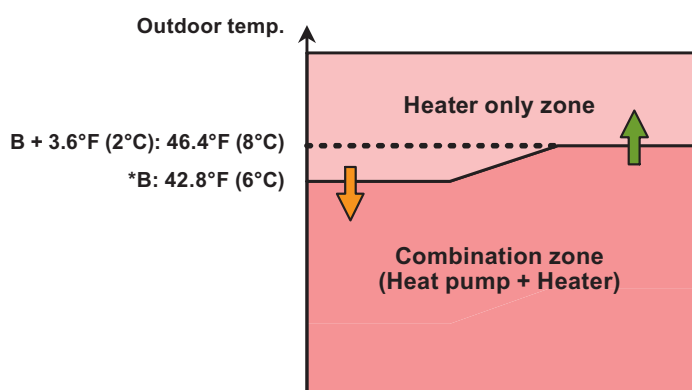

*: Adjustable by function setting 67

• Operation status

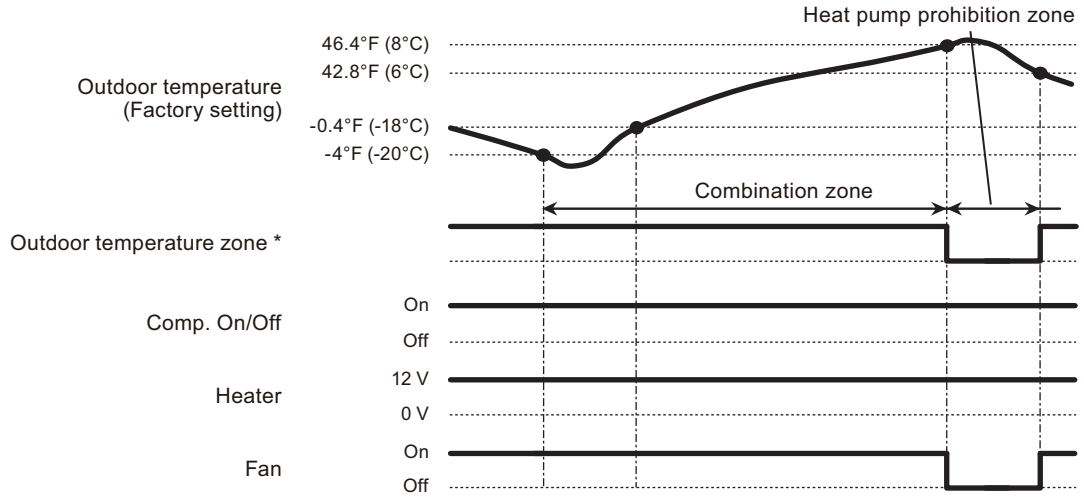

* The outdoor temperature zone transition from one to another will stay in that zone for minimum of 30 min.

NOTE: In following operations, compressor will be on in heat pump prohibition zone.

- Other than heating
- Test run

● Auxiliary heat pump control by outdoor temperature 3

• External heater output

Operation	Condition
Heater on	Heater is on as shown in following diagram of heating temperature.
Heater off	<ul style="list-style-type: none"> • Heater is off as shown in following diagram of heating temperature. • Other than heating mode • Error occurred • Forced thermostat off

- Temperature of heater on (Thon): Set temperature (Ts) - 0.9 °F (- 0.5 °C)
- Temperature of heater off: Set temperature (Ts) + 0.9 °F (+ 0.5 °C)

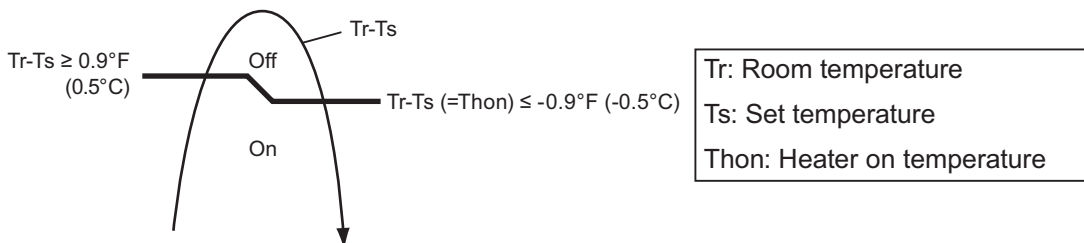

• Auxiliary heat pump On/Off

- Temperature of heater on (Thon): Adjustable by function number 62 (Operating temperature switching of heat pump).
- All control temperatures will shift by adjusting “Thon”.

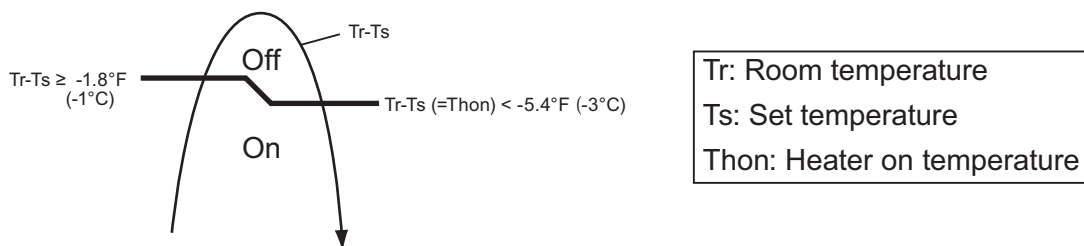

• Outdoor temperature zone

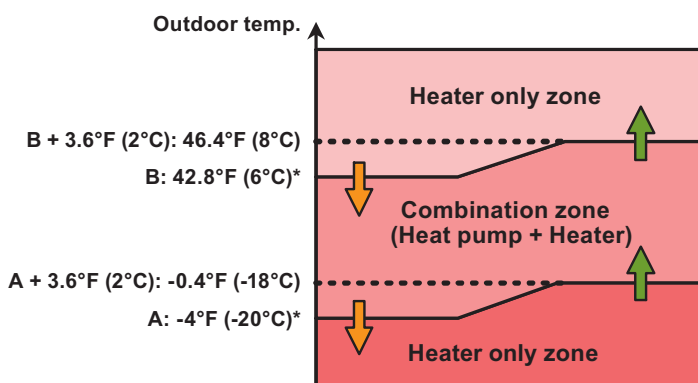

*: Adjustable by function setting 66 and 67

• Operation status

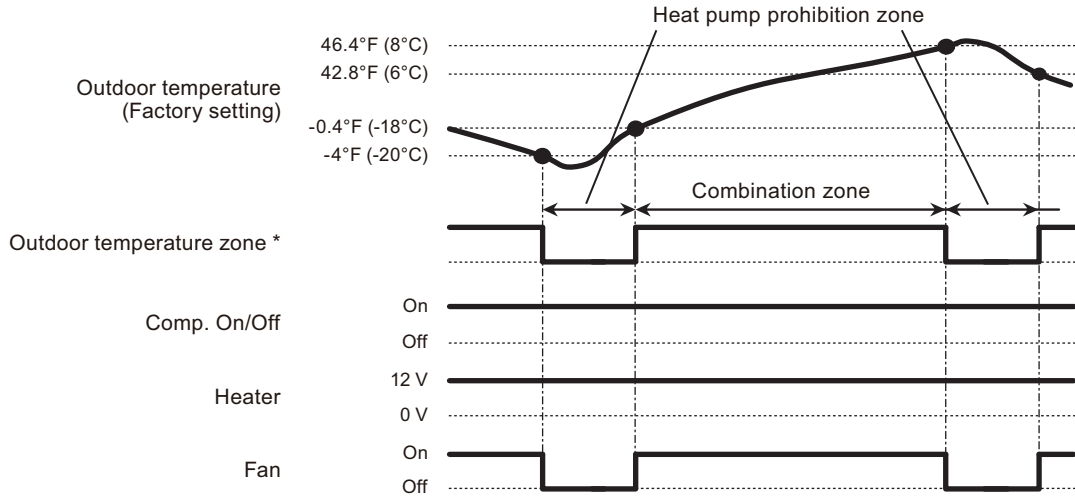

* The outdoor temperature zone transition from one to another will stay in that zone for minimum of 30 min.

NOTE: In following operations, compressor will be on in heat pump prohibition zone.

- Other than heating
- Test run

■ Heating thermostat on for humidifier

Situation	Indoor unit				
	Mode	Function setting	Rotary SW	External output	
		Heating thermostat on no. 60		Heating thermostat on	Indoor unit fan operation status
Example of individual connection	5	60-05	7	CN47	Not used
	6	60-06	8	CN312	
	7	60-07	9	CN311	
	8	60-08	A	CN310	

- Example of individual connection

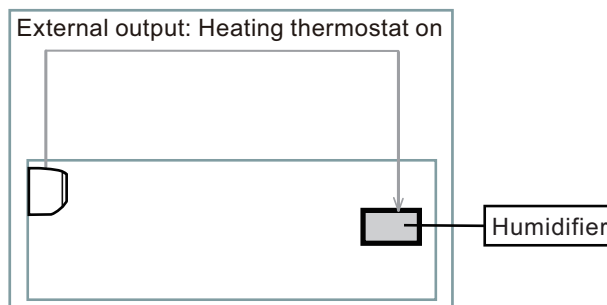

- Operation status

The heating thermostat output for CNB01 (1-2 or 1-3 or 1- or 1-5) will be on when comp on or external heater on.

The heating thermostat output will be off when comp off and external heater off.

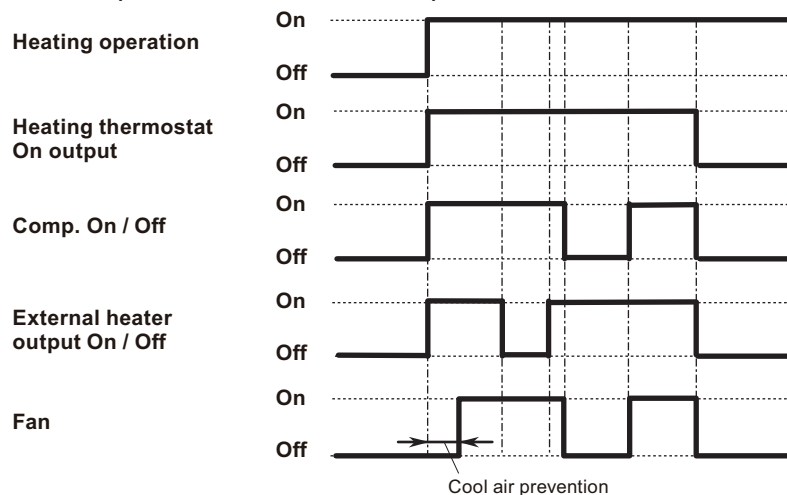

9. Group connection

NOTE: Group control cannot be used together with Wireless LAN adapter.

Installation procedure for group control system:

A number of indoor units can be operated at the same time using a single remote controller.

NOTE: When different type of indoor units (such as wall mounted type and cassette type, cassette type and duct type, or other combinations) are connected using group control system, some functions may no longer be available.

1. Connect up to 16 indoor units in a system.

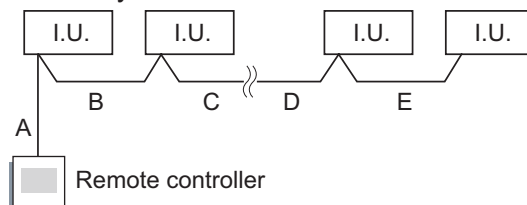

A, B, C, D, E: Remote controller cable	
Wiring length limitation	$A + B + C + D + E \leq 546.8 \text{ yd (500 m)}$

Example of wiring method

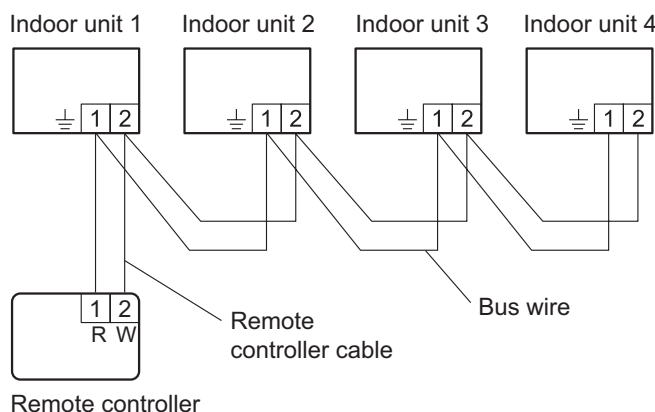

2. Set the R.C. address. (Function setting)

- Addresses will be automatically set when initially starting up this unit. In such a case, do not change the remote controller address for the indoor unit, and keep it at the initial setting of "00".
- Only set addresses manually when using different numbers for addresses. Set the R.C. address of each indoor unit using the function setting. (Refer to "Remote controller address setting" in ["Contents of function setting"](#) on page 52.)

NOTES:

- Do not use the same setting value.
- Setting is reflected after the power is turned on again.

Also set the R.C. address for the remote controller. For details, refer to the remote controller installation manual.

NOTE: In manual setting, connect up to 15 indoor units in a system.

Example of wiring method

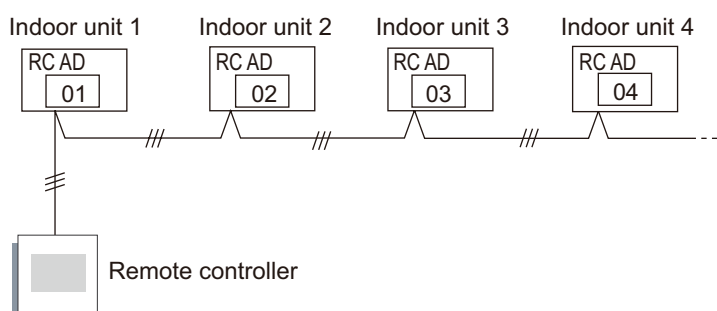

10. Remote controller

10-1. Wireless remote controller

Overview

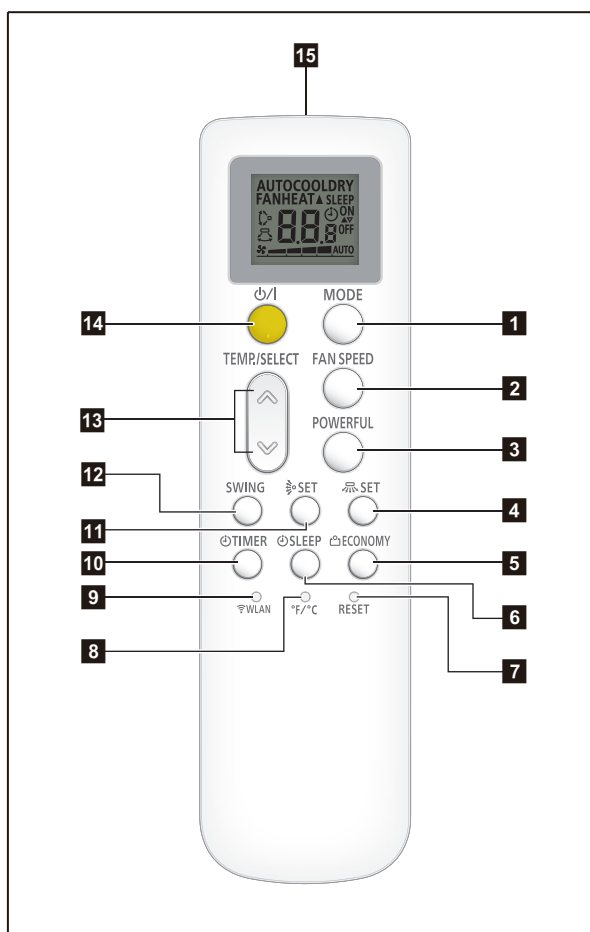

1 MODE button

- Switches operation mode (AUTO, COOL, DRY, FAN, and HEAT).
- Starts/ends the remote controller custom code (max. 4 types) change.

2 FAN SPEED button

- Press the FAN SPEED button while the air conditioner is operating, to control fan speed.
- Press and hold the FAN SPEED button for more than 5 seconds while the air conditioner is stopped, switch the energy saving fan control.

3 POWERFUL button

4 SET button (Left/right airflow)

5 ECONOMY button

6 SLEEP TIMER button

7 RESET button

8 °F/°C button

- Switches the temperature unit on the remote controller display.
- Press and hold the °F/°C button for more than 5 seconds to enter Service check mode.
 - Do not use Service check mode in normal use.
 - If there seems to be a problem, check the error code by referring to the Operation manual.

9 WLAN button

- Starts the wireless LAN setting.
- Press and hold the WLAN button for more than 5 seconds while the air conditioner is operating, to enter test run mode.

10 TIMER button

11 SET button (Up/down airflow)

12 SWING button

13 TEMP./SELECT button

- Adjusts the setting temperature.
- Adjusts the value of the timer settings.
- Sets the remote controller code.

14 START/STOP button

15 Signal transmitter

16 Temperature and time indicator

- Displays set temperature.
- In timer setting, it displays the timer time. After finishing the timer setting, set temperature will reappear.

17 Signal transmit indicator

18 Timer mode indicator

19 Fan speed indicator

20 Swing indicator

21 Operating mode indicator

Display panel

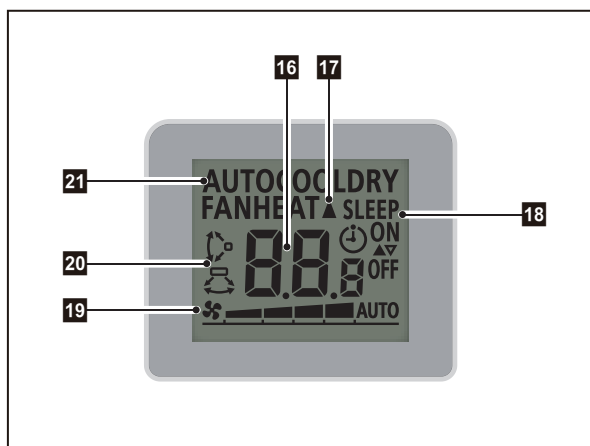

NOTE: Functions may differ by type of the indoor unit. For details, refer to the operation manual.

To facilitate explanation, the accompanying illustration has been drawn to show all possible indicators; in actual operation, however, the display will only show those indicators appropriate to the current operation.

■ Specifications

● Controller

Unit: in (mm)

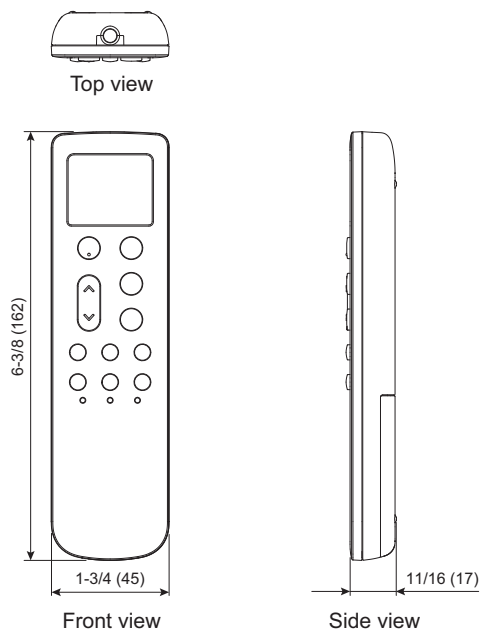

Size (H × W × D)	in (mm)	6-3/8 × 1-3/4 × 11/16 (162 × 45 × 17)
Weight	oz (g)	2.3 (65.5) (without batteries)

● Holder

Unit: in (mm)

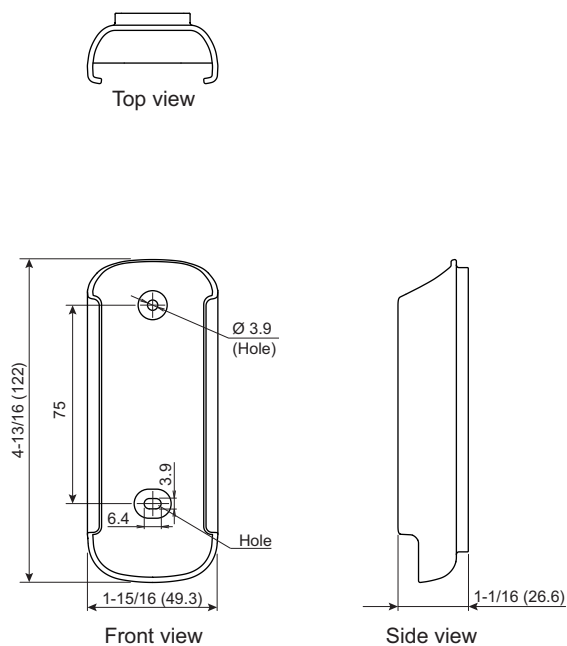

Size (H × W × D)	in (mm)	4-13/16 × 1-15/16 × 1-1/16 (122 × 49.3 × 26.6)
Weight	oz (g)	1 (23.5)

11. Function settings

To adjust the functions of this product according to the installation environment, various types of function settings are available.

NOTE: Incorrect settings can cause a product malfunction.

11-1. Function settings by using remote controller

Some function settings can be changed on the remote controller. After confirming the setting procedure and the content of each function setting, select appropriate functions for your installation environment.

■ Setting procedure by using wireless remote controller

The function number and the associated setting value are displayed on the LCD of the remote controller. Follow the instructions written in the local setup procedure supplied with the remote controller, and select appropriate setting according to the installation environment.

Before connecting the power supply of the indoor unit, reconfirm following items:

- Piping air tight test and vacuuming have been performed firmly.
- There is no wiring mistake.

Then, connect the power supply of the indoor unit.

Entering function setting mode:

While pressing the FAN SPEED button and TEMP./SELECT (^) button simultaneously, press the RESET button to enter the function setting mode.

STEP 1: Setting the remote controller custom code

Use the following steps to select the custom code of the remote controller. (Note that the air conditioner cannot receive a custom code if the air conditioner has not been set for the custom code.)

The custom codes that are set through this process are applicable only to the signal in the function setting.

For details on how to set the custom codes through the normal process, refer to "[Custom code setting for wireless remote controller](#)" on page 59.

1. Press the TEMP./SELECT (^) (v) buttons to change the custom code between \overline{A} → \overline{B} → \overline{C} → \overline{D} . Match the code on the display to the air conditioner custom code. (Initially set to \overline{A} .) If the custom code does not need to be selected, press the MODE button, and proceed to **STEP 2**.
2. Press the MODE button to accept the custom code, and proceed to **STEP 2**.



NOTES:

- The air conditioner custom code is set to \overline{A} prior to shipment.
- The remote controller resets to custom code \overline{A} when the batteries on the remote controller are replaced. If you use a custom code other than code \overline{A} , reset the custom code after replacing the batteries.
- If you do not know the air conditioner custom code setting, try each of the custom codes (\overline{A} → \overline{B} → \overline{C} → \overline{D}) until you find the code that operates the air conditioner.

STEP 2: Selecting the function number and setting value

1. Press the TEMP./SELECT (^) (v) buttons to select the function number. To switch between the left and right digits, press the MODE button.
2. Press the FAN SPEED button to proceed the setting value. To return the function number selection, press the FAN SPEED button again.
3. Press the TEMP./SELECT (^) (v) buttons to select the setting value. To switch between the left and right digits, press the MODE button.
4. Press the TIMER button, and when the indoor unit beeps, press the ϕ /I (START/STOP) button to confirm the settings.
5. Press the RESET button to cancel the function setting mode.
6. After completing the function setting, be sure to disconnect the power supply and then reconnect it.

Function number

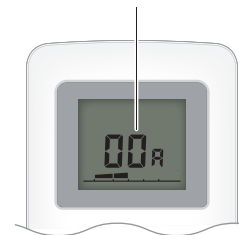

Setting value

**⚠ CAUTION**

- After disconnecting the power supply, wait 30 seconds or more before reconnecting it. The function setting will not become active unless the power supply is disconnected and then reconnected.
- When using a custom code other than A, press [RESET] and then press and hold [MODE] again for 5 seconds or more to set the custom code.

■ Contents of function setting

Each function setting listed in this section is adjustable in accordance with the installation environment.

NOTE: Setting will not be changed if invalid numbers or setting values are selected.

● Function setting list

	Function no.	Functions
1)	11	Filter sign
2)	30/31	Room temperature control for indoor unit sensor
3)	35/36	Room temperature control for wired remote controller sensor
4)	40	Auto restart
5)	42	Room temperature sensor switching
6)	44	Remote controller custom code
7)	46	External input control
8)	48	Room temperature sensor switching (Aux.)
9)	49	Indoor unit fan control for energy saving for cooling
10)	60	Switching functions for external output terminal
11)	61	Control switching of external heaters
12)	62	Operating temperature switching of external heaters
13)	66	Outdoor temperature zone boundary temperature A
14)	67	Outdoor temperature zone boundary temperature B
15)	71	Standby time for auxiliary equipment operation
16)	72	Heat pump backup setting
17)	73	Emergency heat for external output terminal
18)	95	Heat insulation condition (building insulation)

1) Filter sign

Select appropriate intervals for displaying the filter sign on the indoor unit according to the estimated amount of dust in the air of the room.

If the indication is not required, select "No indication" (03).

Function number	Setting value	Setting description	Factory setting
11	00	Standard (400 hours)	
	01	Long interval (1,000 hours)	
	02	Short interval (200 hours)	
	03	No indication	◆

2) Room temperature control for indoor unit sensor

NOTE: Before performing this setting, refer to Function 95.

Depending on the installed environment, correction of the room temperature sensor may be required. Select the appropriate control setting according to the installed environment.

The temperature of the room temperature sensor is corrected as follows:

Corrected temp. = Temp. of the room temp. sensor - Correction temp. value

Example of correction:

When the temperature of the room temp. sensor is 78°F and the setting value is "03" (-2°F), the corrected temp. will be 80°F (78°F - [-2°F]).

The temperature correction values show the difference from the Standard setting "00" (manufacturer's recommended value).

*When Function 95-01 (High insulation) is set, the Standard setting "00" will be the same as "No correction 0.0 °F (0.0 °C)" (01).

Function number		Setting value	Setting description	Factory setting	
30 (For cooling)	31 (For heating)	00	Standard setting*	◆	
		01	No correction 0.0 °F (0.0 °C)		
		02	-1 °F (-0.5 °C)	More cooling Less heating	
		03	-2 °F (-1.0 °C)		
		04	-3 °F (-1.5 °C)		
		05	-4 °F (-2.0 °C)		
		06	-5 °F (-2.5 °C)		
		07	-6 °F (-3.0 °C)		
		08	-7 °F (-3.5 °C)		
		09	-8 °F (-4.0 °C)		
		10	+1 °F (+0.5 °C)	Less cooling More heating	
		11	+2 °F (+1.0 °C)		
		12	+3 °F (+1.5 °C)		
		13	+4 °F (+2.0 °C)		
		14	+5 °F (+2.5 °C)		
		15	+6 °F (+3.0 °C)		
		16	+7 °F (+3.5 °C)		
17	+8 °F (+4.0 °C)				

3) Room temperature control for wired remote controller sensor

NOTE: Before performing this setting, refer to Function 95.

Depending on the installed environment, correction of the wire remote temperature sensor may be required. Select the appropriate control setting according to the installed environment.

To change this setting, set Function 42 to "Both" (01).

Ensure that the Thermo Sensor icon is displayed on the remote controller screen.

*When Function 95-01 (High insulation) is set, the Standard setting "00" will be the same as "No correction 0.0 °C" (01).

Function number		Setting value	Setting description	Factory setting	
35 (For cooling)	36 (For heating)	00	Standard setting*	◆	
		01	No correction 0.0 °F (0.0 °C)		
		02	-1 °F (-0.5 °C)	More cooling Less heating	
		03	-2 °F (-1.0 °C)		
		04	-3 °F (-1.5 °C)		
		05	-4 °F (-2.0 °C)		
		06	-5 °F (-2.5 °C)		
		07	-6 °F (-3.0 °C)		
		08	-7 °F (-3.5 °C)		
		09	-8 °F (-4.0 °C)		
		10	+1 °F (+0.5 °C)	Less cooling More heating	
		11	+2 °F (+1.0 °C)		
		12	+3 °F (+1.5 °C)		
		13	+4 °F (+2.0 °C)		
		14	+5 °F (+2.5 °C)		
		15	+6 °F (+3.0 °C)		
		16	+7 °F (+3.5 °C)		
17	+8 °F (+4.0 °C)				

4) Auto restart

Enables or disables automatic restart after a power interruption.

Function number	Setting value	Setting description	Factory setting
40	00	Enable	◆
	01	Disable	

NOTE: Auto restart is an emergency function such as for power outage etc. Do not attempt to use this function in normal operation. Be sure to operate the unit by remote controller or external device.

5) Room temperature sensor switching

(Only for wired remote controller)

When using the wired remote controller temperature sensor, change the setting to "Both" (01).

Function number	Setting value	Setting description	Factory setting
42	00	Indoor unit	◆
	01	Both	

00: Sensor on the indoor unit is active.

01: Sensors on both indoor unit and wired remote controller are active.

NOTE: Remote controller sensor must be turned on by using the remote controller.

6) Remote controller custom code

(Only for wireless remote controller)

The indoor unit custom code can be changed. Select the appropriate custom code.

Function number	Setting value	Setting description	Factory setting
44	00	A	◆
	01	B	
	02	C	
	03	D	

7) External input control

"Operation/Stop" mode or "Forced stop" mode can be selected.

Function number	Setting value	Setting description	Factory setting
46	00	Operation/Stop mode 1 (R.C. enabled)	◆
	01	(Setting prohibited)	
	02	Forced stop mode	
	03	Operation/Stop mode 2 (R.C. disabled)	

8) Room temperature sensor switching (Aux.)

To use the temperature sensor on the wired remote controller only, change the setting to "Wired remote controller" (01).

This function will only work if the function setting 42 is set at "Both" (01).

When the setting value is set to "Both" (00), more suitable control of the room temperature is possible by setting function setting 30 and 31 too.

Function number	Setting value	Setting description	Factory setting
48	00	Both	◆
	01	Wired remote controller	

9) Indoor unit fan control for energy saving for cooling

Enables or disables the power-saving function by controlling the indoor unit fan rotation when the outdoor unit is stopped during cooling operation.

Function number	Setting value	Setting description	Factory setting
49	00	Disable	
	01	Enable	
	02	Remote controller	◆

00: When the outdoor unit is stopped, the indoor unit fan operates continuously following the setting on the remote controller.

01: When the outdoor unit is stopped, the indoor unit fan operates intermittently at a very low speed.

02: Enable or disable this function by remote controller setting.

NOTES:

- As the factory setting, this setting is initially invalidated.
- Set to "00" or "01" when connecting a remote controller that cannot set the Fan control for energy saving function or connecting a network converter.
To confirm if the remote controller has this setting, refer to the operating manual of each remote controller.

10) Switching functions for external output terminal

Functions of the external output terminal can be switched. For details, refer to “External input and output”.

Function number	Setting value	Setting description	Factory setting
60	00	Operation status	◆
	01—04	Cooling thermostat On	
	05	Heating operation	
	06	Operation/Stop	
	07—08	Cooling thermostat On	
	09	Error status	
	10	Indoor unit fan operation status	
	11	External heater	

11) Control switching of external heaters

Sets the control method for external heater to be used.

For details, refer to “External heater output” in Chapter 8-4. ["Details of function"](#) on page 24.

Function number	Setting value	Setting description	Factory setting
61	00	Auxiliary heater control 1	◆
	01	Auxiliary heater control 2	
	02	Heat pump prohibition control	
	03	Auxiliary heater control by outdoor temperature 1	
	04	Auxiliary heater control by outdoor temperature 2	
	05	Auxiliary heater control by outdoor temperature 3	
	06	Auxiliary heat pump control	
	07	Auxiliary heat pump control by outdoor temperature 1	
	08	Auxiliary heat pump control by outdoor temperature 2	
	09	Auxiliary heat pump control by outdoor temperature 3	

12) Operating temperature switching of external heaters

Sets the temperature conditions when the external heater is ON.

For details, refer to “External heater output” in Chapter 8-4. ["Details of function"](#) on page 24.

Function number	Setting value	Setting description		Factory setting
		Heater: On	Heater: Off	
62	00	-5.4 °F (-3 °C)	-1.8 °F (-1 °C)	◆
	01	-3.6 °F (-2 °C)	-1.8 °F (-1 °C)	
	02	-3.6 °F (-2 °C)	-1.8 °F (-1 °C)	
	03	-5.4 °F (-3 °C)	-1.8 °F (-1 °C)	
	04	-7.2 °F (-4 °C)	-1.8 °F (-1 °C)	
	05	-9.0 °F (-5 °C)	-1.8 °F (-1 °C)	

13) Outdoor temperature zone boundary temperature A

Setting required if changing of the outdoor temperature setting for heat pump prohibition zone is required when auxiliary heater control by outdoor temperature 1 and 2 are performed on the indoor unit. For details, refer to "External heater output" in Chapter 8-4. "[Details of function](#)" on page 24.

Function number	Setting value	Setting description	Factory setting
66	00	-4.0 °F (-20 °C)	◆
	01	-0.4 °F (-18 °C)	
	02	3.2 °F (-16 °C)	
	03	6.8 °F (-14 °C)	
	04	10.4 °F (-12 °C)	
	05	14.0 °F (-10 °C)	
	06	17.6 °F (-8 °C)	
	07	21.2 °F (-6 °C)	
08	24.8 °F (-4 °C)		

14) Outdoor temperature zone boundary temperature B

Setting required if changing of the outdoor temperature setting for heat pump only zone is required when auxiliary heater control by outdoor temperature 1 is performed on the indoor unit. For details, refer to "External heater output" in Chapter 8-4. "[Details of function](#)" on page 24.

Function number	Setting value	Setting description	Factory setting
67	00	42.8 °F (6 °C)	◆
	01	14.0 °F (-10 °C)	
	02	17.6 °F (-8 °C)	
	03	21.2 °F (-6 °C)	
	04	24.8 °F (-4 °C)	
	05	28.4 °F (-2 °C)	
	06	32.0 °F (0 °C)	
	07	35.6 °F (2 °C)	
	08	39.2 °F (4 °C)	
	09	42.8 °F (6 °C)	
	10	46.4 °F (8 °C)	
	11	50.0 °F (10 °C)	
	12	53.6 °F (12 °C)	
	13	57.2 °F (14 °C)	
	14	60.8 °F (16 °C)	
15	64.4 °F (18 °C)		

15) Standby time for auxiliary equipment operation

Sets the standby time until the auxiliary equipment operation starts during primary equipment operation.

For details, refer to Chapter 8-4. "[Details of function](#)" on page 24.

Function number	Setting value	Setting description	Factory setting
71	00	Disable	◆
	01	1 minute	
	02	2 minutes	
	•	•	
	•	•	
	•	•	
	98	98 minutes	
	99	99 minutes	

16) Heat pump backup setting

Enables or disables the heat pump backup instruction from the outdoor unit.

This function will be usable provided that the corresponding outdoor unit is connected.

Function number	Setting value	Setting description	Factory setting
72	00	Disable	◆
	01	Enable	

17) Emergency heat for external output terminal

Enables or disables emergency heat input.

Function number	Setting value	Setting description	Factory setting
73	00	Disable	◆
	01	Enable	

NOTE: When this function is used, IR receiver unit is necessary.

18) Heat insulation condition (building insulation)

Heat insulation conditions differ according to the installed environment.

"Standard insulation" (00) allows system to rapidly respond to the cooling or heating load changes.

"High insulation" (01) is when the heat insulation structure of the building is high and does not require system to rapidly respond to cooling or heating load changes.

When "High insulation" (01) is selected:

- Overheating (overcooling) is prevented at the start-up.
- All room-temperature control settings (Function 30, 31, 35, and 36) will reset to "No correction 0.0 °F (0.0 °C)".

Function number	Setting value	Setting description	Factory setting
95	00	Standard insulation	◆
	01	High insulation	

NOTE: When changing Function 95, perform this setting before other room-temperature control settings (Function 30, 31, 35, and 36). If Function 95 is not set first, room-temperature control settings (Function 30, 31, 35, and 36) will be reset and you must re-do them again.

11-2. Custom code setting for wireless remote controller

■ Custom code setting on AR-RPB2U

To interconnect the air conditioner and the wireless remote controller, assignment of the custom code for the wireless remote controller is required.

NOTE: Air conditioner cannot receive a signal if the air conditioner has not been set for the custom code.

When 2 or more air conditioners are installed in a room, and the remote controller is operating an air conditioner other than the one you wish to set, change the custom code of the remote controller to operate only the air conditioner you wish to set. (4 selections possible.)

Confirm the setting of the remote controller custom code and the function setting. If these do not match, the remote controller cannot be used to operate for the air conditioner.

1. Press the $\phi/1$ (START/STOP) button until the indicators on the remote controller turn off.
2. Press the MODE button for at least 5 seconds to display the current custom code. (Initially set to \overline{A} .)
3. Press the TEMP./SELECT (\wedge) (\vee) buttons to change the custom code between $\overline{A} \rightarrow \overline{B} \rightarrow \overline{C} \rightarrow \overline{D}$. Match the code on the display to the air conditioner custom code. (Initially set to \overline{A} .)
4. Press the MODE button again to return to the original display. The custom code will be changed.











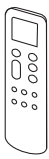
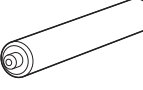

NOTES:

- If no button is pressed within 30 seconds after the custom code is displayed, the system returns to the original display. In this case, start again from step 1.
- The air conditioner custom code is set to \overline{A} prior to shipment. To change the custom code, contact your retailer.
- If you do not know the assigned code for the air conditioner, try each of the custom code ($\overline{A} \rightarrow \overline{B} \rightarrow \overline{C} \rightarrow \overline{D}$) until you find the code which operates the air conditioner.

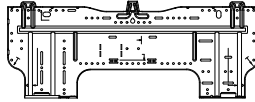
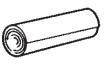

12. Accessories

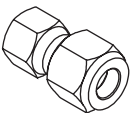
12-1. Models: ASUH18LPAS and ASUH24LPAS

Part name	Exterior	Q'ty	Part name	Exterior	Q'ty
Operating manual		1	Tapping screw (large)		5
Installation manual		1	Tapping screw (small)		2
Remote controller		1	Battery		2
Remote controller holder		1	Wall hook bracket		1
Cloth tape		1	Ion deodorization filter		1
Filter holder		2	Apple-catechin filter		1
Adapter, 1/2 (12.7)→5/8 (15.88) [in (mm)] (Only for 24 model)		1			

13. Optional parts

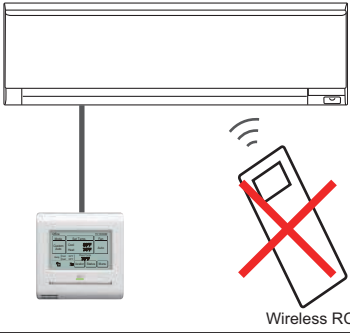
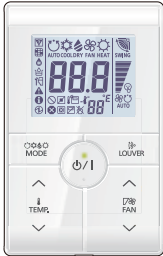





13-1. Controllers

Exterior	Part name	Model name	Summary
	Wired remote controller	UTY-RNRUZ*	<p>Easy finger touch operation with LCD panel. Backlit LCD enables easy operation in a dark room. Wire type: Non-polar 2-wire Optional communication kit is necessary for installation.</p> <p>NOTE: When this remote controller is connected, wireless remote controller cannot be used.</p>  <p style="text-align: center;">Wireless RC</p>
	Simple remote controller	UTY-RSRY	<p>Compact remote controller concentrates on the basic functions such as Start/Stop, fan control, temperature setting, and operation mode. Wire type: Non-polar 2-wire Optional communication kit is necessary for installation.</p>
	Simple remote controller	UTY-RHRY	<p>Compact remote controller concentrates on the basic functions such as Start/Stop, fan control, and temperature setting. Wire type: Non-polar 2-wire Optional communication kit is necessary for installation.</p>

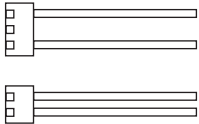
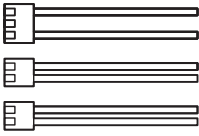
NOTES:

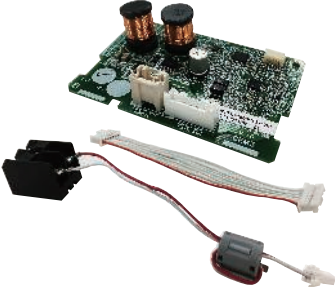
- Available functions may differ by the remote controller. For details, refer to the operation manual.
- When using a Wireless LAN adapter, group controlling system of the wired remote controller is prohibited.

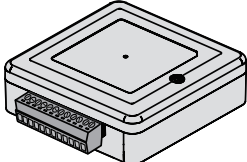
13-2. Others

Exterior	Part name	Model name	Summary
	External connect kit	UTY-XWZX	Use to connect with various peripheral devices and air conditioner PCB.
	External connect kit	UTY-XWZXZ5	Required when external device is connected.
	External input and output PCB	UTY-XCSXZ2	Use to connect with external devices and air conditioner PCB. Optional External connect kit is necessary for installation.
	Communication kit	UTY-TWRXZ2	Use to connect Non-polar 2-core wired remote controller.
	Wireless LAN adapter	UTY-TFSXF1	Remotely manage an air conditioning system using mobile devices such as smartphones and tablets.
	Modbus converter	UTY-VMSX	For connection between indoor unit with UART interface and a Modbus open network.
	Thermostat converter	UTY-TTRX	This converter can control Fujitsu General products using a third-party thermostat controller.
	Network converter	UTY-VTGX	This converter is required when connecting single split system to VRF network system.

Part 2. OUTDOOR UNIT

SINGLE TYPE:

AOUH18LPAS1

AOUH24LPAS1

1. Specifications

Type				Inverter heat pump		
Model name				AOUH18LPAS1	AOUH24LPAS1	
Power supply				208/230 V ~ 60 Hz		
Power supply intake				Outdoor unit		
Available voltage range				187—253 V		
Starting current				A		
Fan	Airflow rate	Cooling	CFM (m ³ /h)	6.7	11.4	
		Heating		1,348 (2,290)	1,560 (2,650)	
	Type × Q'ty	Propeller fan × 1				
Motor output			W	49		
Sound pressure level *1		Cooling	dB (A)	50	53	
		Heating		50	54	
Heat exchanger type		Dimensions (H × W × D)	in (mm)	Main1: 23-1/8 × 34-11/16 × 11/16 (588 × 881 × 18.19)		
		Fin pitch		FPI	Main2: 23-1/8 × 33-1/2 × 11/16 (588 × 851 × 18.19)	
		Rows × Stages	20			
		Pipe type	Main1: 1 × 28 Main2: 1 × 28			
		Fin type	Type (Material)	Copper		
			Surface treatment	Aluminum PC fin		
Compressor		Type	DC rotary			
		Motor output	W	1,030		
Refrigerant		Type	R410A			
		Charge	lb oz	2 lb 16 oz		
			g	1,350		
Refrigerant oil		Type	RB68			
		Amount	in ³ (cm ³)	24.4 (400)		
Enclosure		Material	Steel sheet			
		Color	Beige Approximate color of Munsell 10YR 7.5/1.0			
Dimensions (H × W × D)		Net	in (mm)	24-7/8 × 31-7/16 × 11-7/16 (632 × 799 × 290)		
		Gross		27-1/4 × 37 × 14-3/4 (692 × 940 × 375)		
Weight		Net	lb (kg)	86 (39)		
		Gross		95 (43)		
Connection pipe		Size	in (mm)	Ø 1/4 (Ø 6.35)		
		Liquid		Ø 1/2 (Ø 12.7)		
		Gas				
		Method	Flare			
Pre-charge length		ft (m)		49 (15)		
				66 (20)		
				49 (15)		
Max. height difference		°F (°C)		14 to 115 (-10 to 46)		
				5 to 75 (-15 to 24)		
Drain hose		Material	PP			
		Tip diameter	in (mm)	Ø 1/2 (Ø 13.0) (I. D.), Ø 5/8 to 11/16 (Ø 16.0 to 16.8) (O. D.)		

NOTES:

- Specifications are based on the following conditions:
 - Cooling: Indoor temperature of 80 °FDB (26.67 °CDB) / 67 °FWB (19.44 °CWB), and outdoor temperature of 95 °FDB (35 °CDB) / 75 °FWB (23.9 °CWB).
 - Heating: Indoor temperature of 70 °FDB (21.11 °CDB) / 59 °FWB (15 °CWB), and outdoor temperature of 47 °FDB (8.33 °CDB) / 43 °FWB (6.11 °CWB).
 - Pipe length: 24 ft 6 in (7.5 m), Height difference: 0 ft (0 m). (Between outdoor unit and indoor unit.)
- Protective function might work when using it outside the operation range.
- *1: Sound pressure level
 - Measured values in manufacturer's anechoic chamber.
 - Because of the surrounding sound environment, the sound levels measured in actual installation conditions might be higher than the specified values here.

2. Dimensions

2-1. Models: AOUH18LPAS1 and AOUH24LPAS1

Unit: in (mm)

OUTDOOR UNIT
AOUH18-24LPAS1

OUTDOOR UNIT
AOUH18-24LPAS1

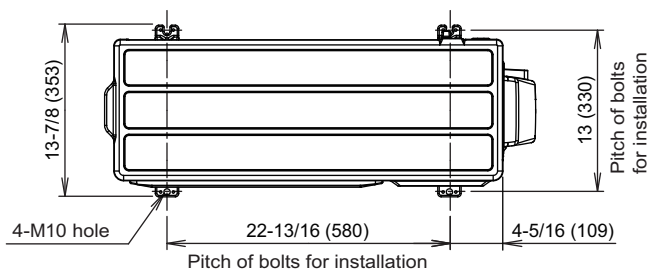

Top view

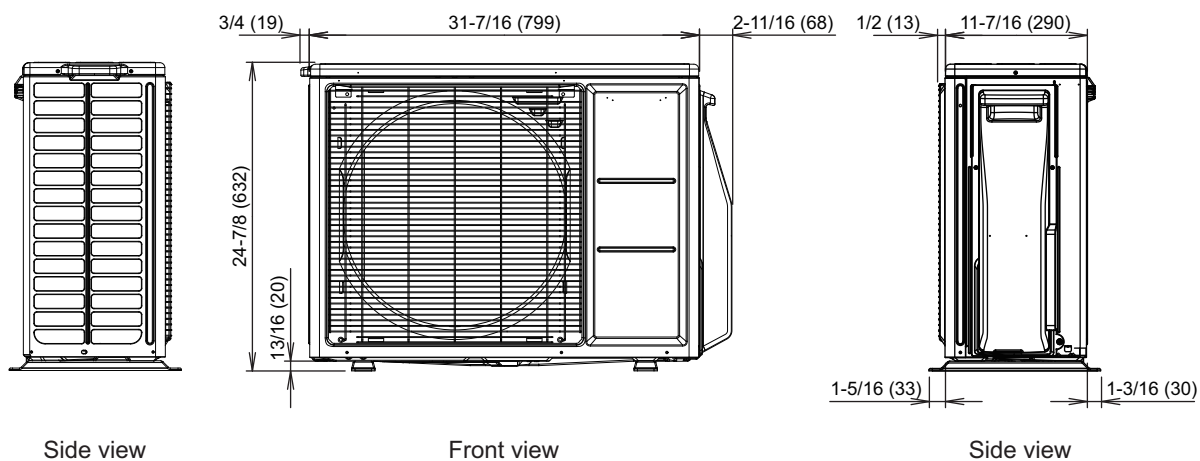

Side view

Front view

Side view

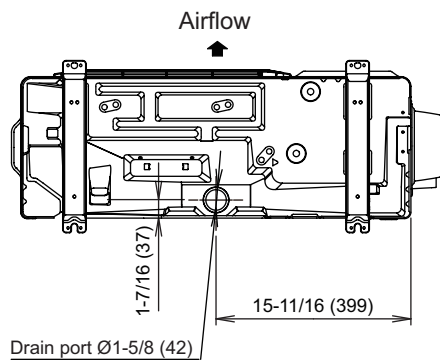

Bottom view

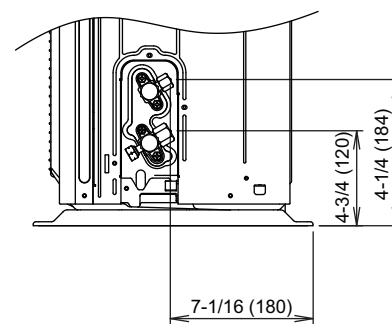

Side view (Valve part)

3. Installation space

3-1. Models: AOUH18LPAS1 and AOUH24LPAS1

■ Space requirement

Provide sufficient installation space for product safety.

⚠ CAUTION

Keep the space shown in the installation examples.

If the installation is not performed accordingly, it could cause a short circuit and result in a lack of operating performance.

● Single outdoor unit installation

- When the upper space is open:

Unit: in (mm)

Obstacles at rear only

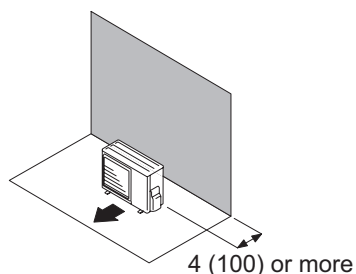

Obstacles at rear and sides

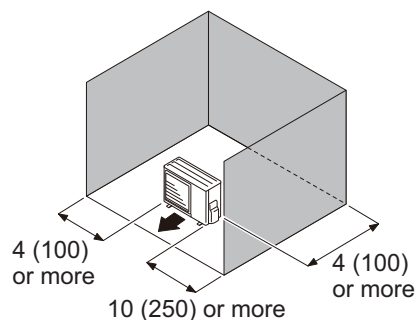

Obstacles at front

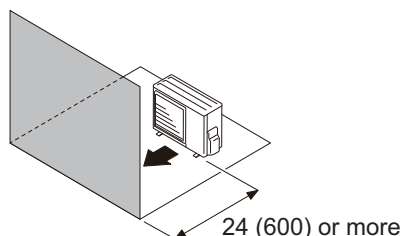

Obstacles at front and rear

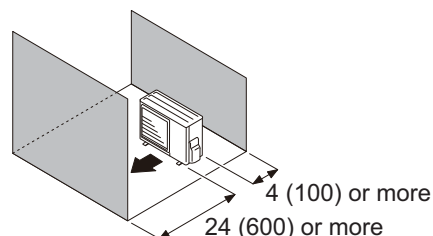

- When an obstruction in the upper space:

Unit: in (mm)

Obstacles at rear and above

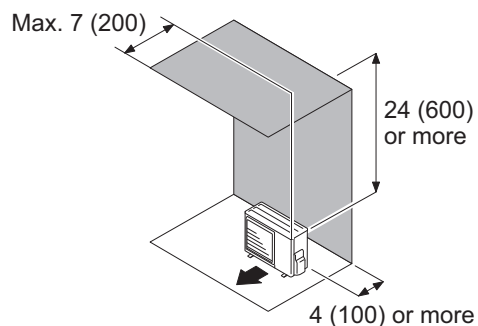

Obstacles at rear, sides, and above

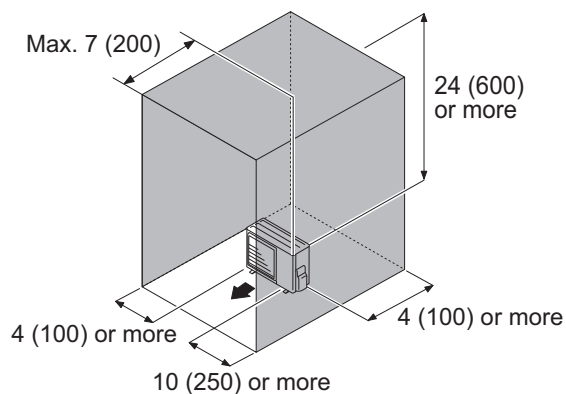

● Multiple outdoor unit installation

- Provide at least 10 in (250 mm) of space between the outdoor units if multiple units are installed.
- When routing the piping from the side of an outdoor unit, provide space for piping.
- No more than 3 units must be installed side by side.
When 4 units or more are arranged in a line, provide the space as shown in the following example **“When an obstruction in the upper space:”**.
- **When the upper space is open:**

Unit: in (mm)

Obstacles at rear only

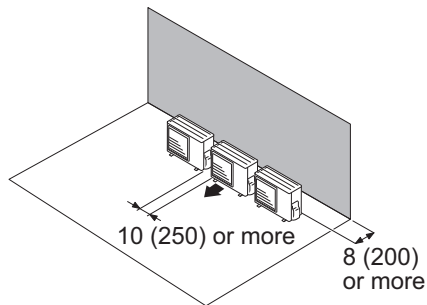

Obstacles at front only

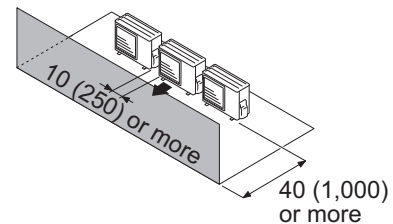

Obstacles at front and rear

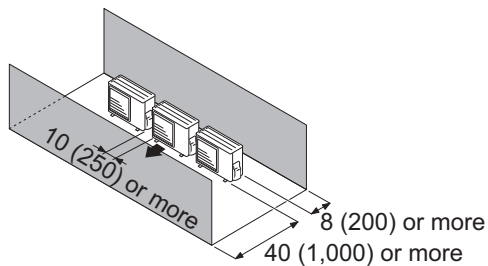

- **When an obstruction in the upper space:**

Unit: in (mm)

Obstacles at rear and above.

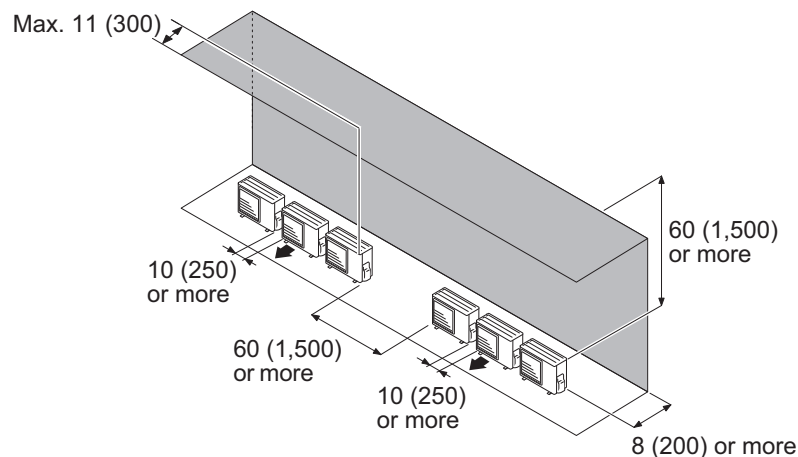

● Outdoor units installation in multi-row

Unit: in (mm)

Single parallel unit arrangement

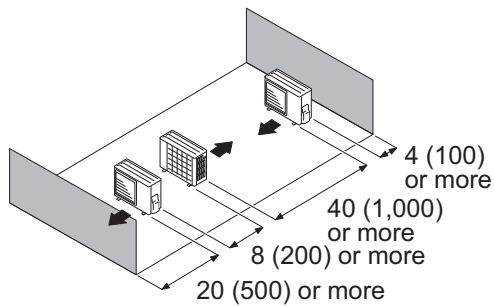

Multiple parallel unit arrangement

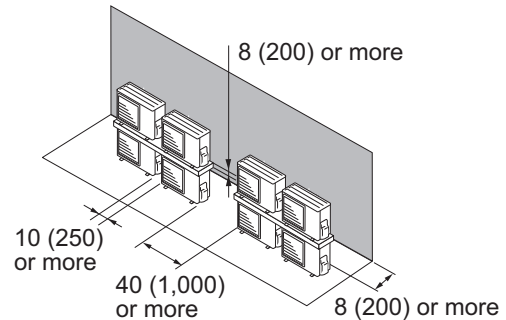
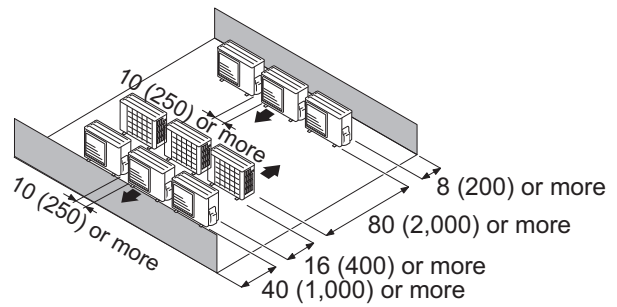

NOTES:

- If the space is larger than stated above, the condition will be the same as when there is no obstacle.
- When installing the outdoor unit, be sure to open the front and left side to obtain better operation efficiency.

⚠ CAUTION

- Do not install the outdoor unit in two-stage where the drain water could freeze. Otherwise the drainage from the upper unit may form ice and cause a malfunction of the lower unit.
- When the outdoor temperature is 32 °F (0 °C) or less, do not use the accessory drain pipe and drain cap. If the drain pipe and drain cap are used, the drain water in the pipe may freeze in extremely cold climate. (For reverse cycle model only.)
- In area with heavy snowfall, if the inlet and outlet of the outdoor unit is blocked with snow, it might become difficult to get warm, and it is likely to cause product malfunction. Construct a canopy and a pedestal, or place the unit on a high stand that is locally installed.

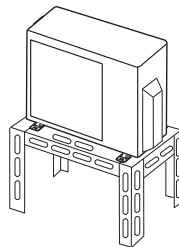

4. Refrigerant circuit

4-1. Models: AOUH18LPAS1 and AOUH24LPAS1

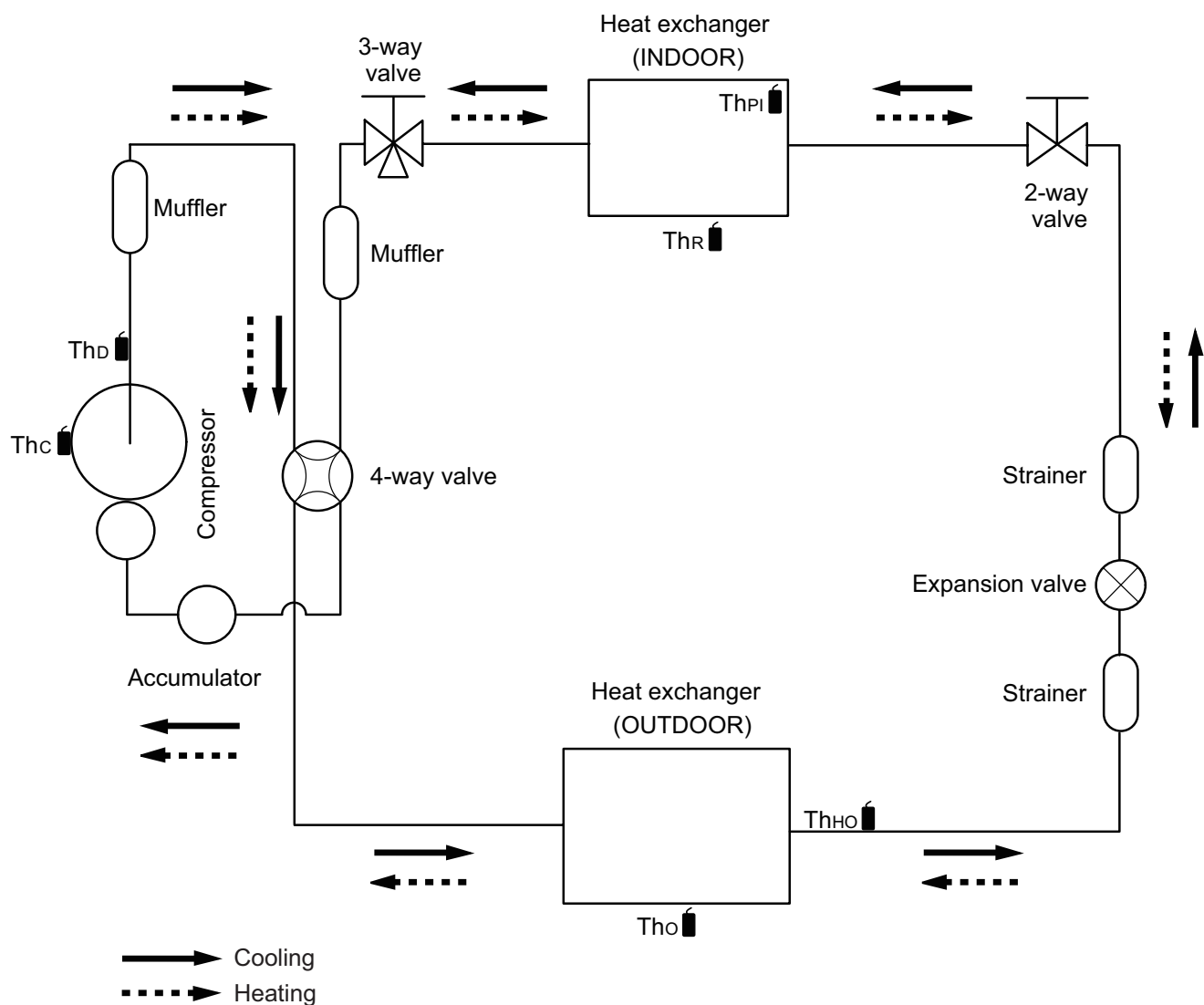

- Th_c : Thermistor (Compressor temperature)
 Th_d : Thermistor (Discharge temperature)
 Th_o : Thermistor (Outdoor temperature)
 Th_{HO} : Thermistor (Heat exchanger out temperature)
 Th_R : Thermistor (Room temperature)
 Th_{PI} : Thermistor (Pipe temperature)

5. Wiring diagrams

5-1. Models: AOUH18LPAS1 and AOUH24LPAS1

OUTDOOR UNIT
AOUH18-24LPAS1

OUTDOOR UNIT
AOUH18-24LPAS1

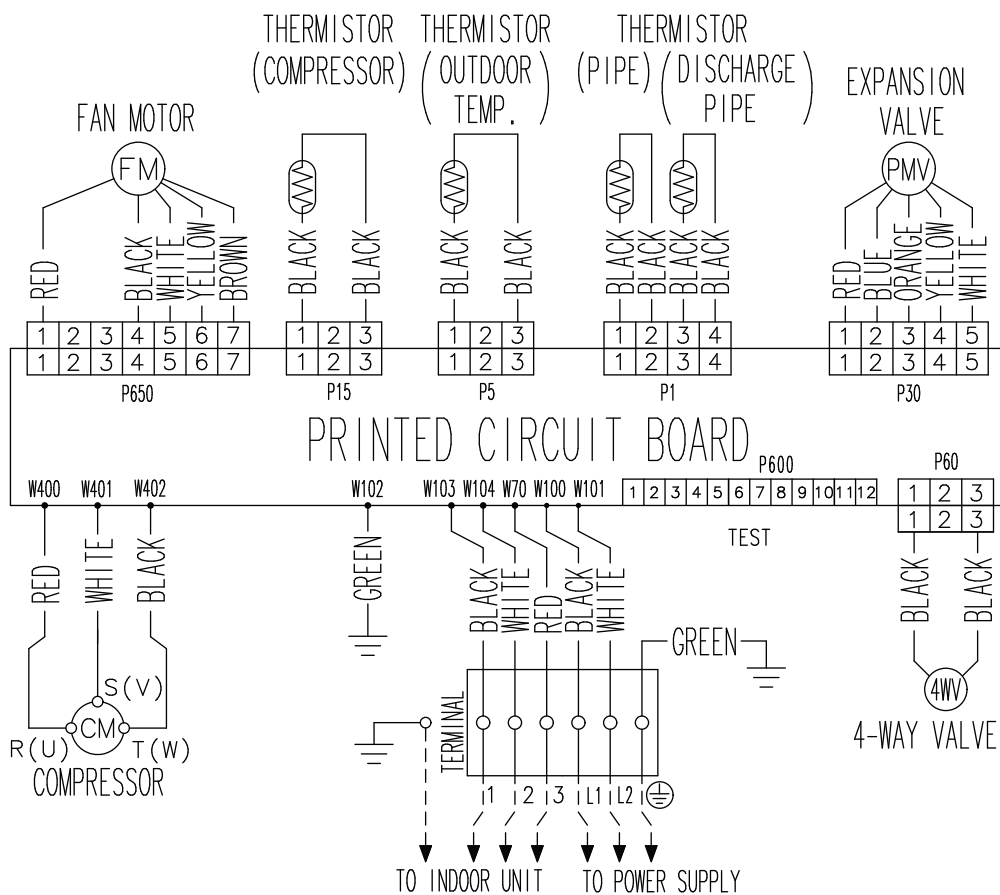

6. Capacity compensation rate for pipe length and height difference

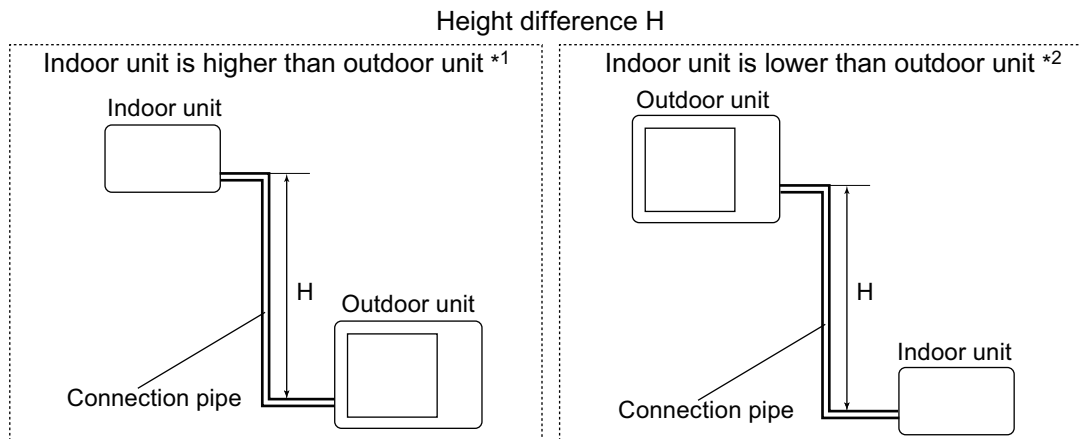

6-1. Models: AOUH18LPAS1 and AOUH24LPAS1

NOTE: Values mentioned in the table are calculated based on the maximum capacity.

COOLING		Pipe length						
		m						
			ft	5 16	7.5 25	10 33	15 49	20 66
Height difference H	Indoor unit is higher than outdoor unit *1	15	49	-	-	-	0.951	0.950
		10	33	-	-	0.979	0.967	0.966
		7.5	25	-	0.988	0.983	0.971	0.970
		5	16	0.994	0.992	0.987	0.975	0.974
	0	0	1.002	1.000	0.995	0.983	0.982	
Indoor unit is lower than outdoor unit *2	-5	-16	1.002	1.000	0.995	0.983	0.982	
	-7.5	-25	-	1.000	0.995	0.983	0.982	
	-10	-33	-	-	0.995	0.983	0.982	
	-15	-49	-	-	-	0.983	0.982	

HEATING		Pipe length						
		m						
			ft	5 16	7.5 25	10 33	15 49	20 66
Height difference H	Indoor unit is higher than outdoor unit *1	15	49	-	-	-	0.994	0.979
		10	33	-	-	1.012	0.994	0.979
		7.5	25	-	1.000	1.012	0.994	0.979
		5	16	0.969	1.000	1.012	0.994	0.979
	0	0	0.969	1.000	1.012	0.994	0.979	
Indoor unit is lower than outdoor unit *2	-5	-16	0.964	0.995	1.007	0.989	0.974	
	-7.5	-25	-	0.993	1.004	0.986	0.972	
	-10	-33	-	-	1.002	0.984	0.969	
	-15	-49	-	-	-	0.974	0.959	

7. Additional charge calculation

7-1. Models: AOUH18LPAS1 and AOUH24LPAS1

Refrigerant type	R410A	
Refrigerant amount	lb oz	2 lb 16 oz
	g	1,350

■ Refrigerant charge

Total pipe length	ft	49 or less	66 (Max.)	0.22 oz/ft (20 g/m)
	m	15 or less	20 (Max.)	
Additional charge	oz	0	3.5	
	g	0	100	

8. Airflow

8-1. Model: AOUH18LPAS1

● Cooling

m ³ /h	2,290
l/s	636
CFM	1,348

● Heating

m ³ /h	2,290
l/s	636
CFM	1,348

8-2. Model: AOUH24LPAS1

● Cooling

m ³ /h	2,650
l/s	736
CFM	1,560

● Heating

m ³ /h	2,650
l/s	736
CFM	1,560

9. Operation noise (sound pressure)

9-1. Noise level curve

Model: AOUH18LPAS1

Cooling

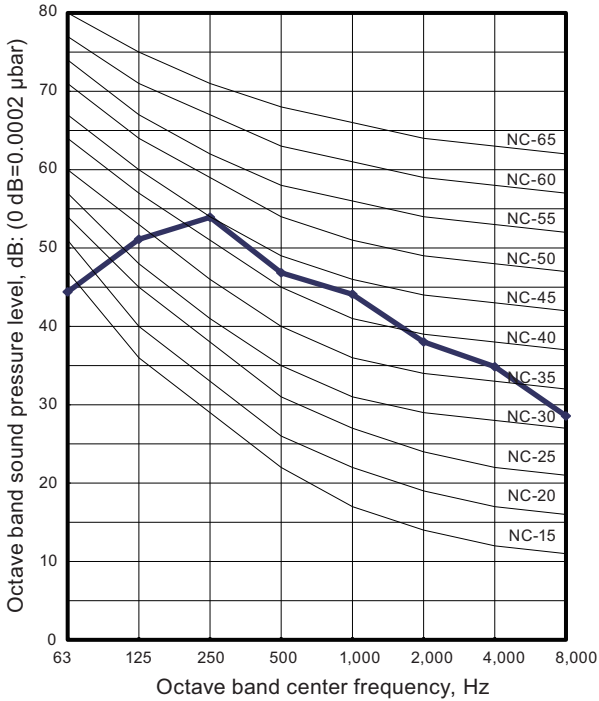

Heating

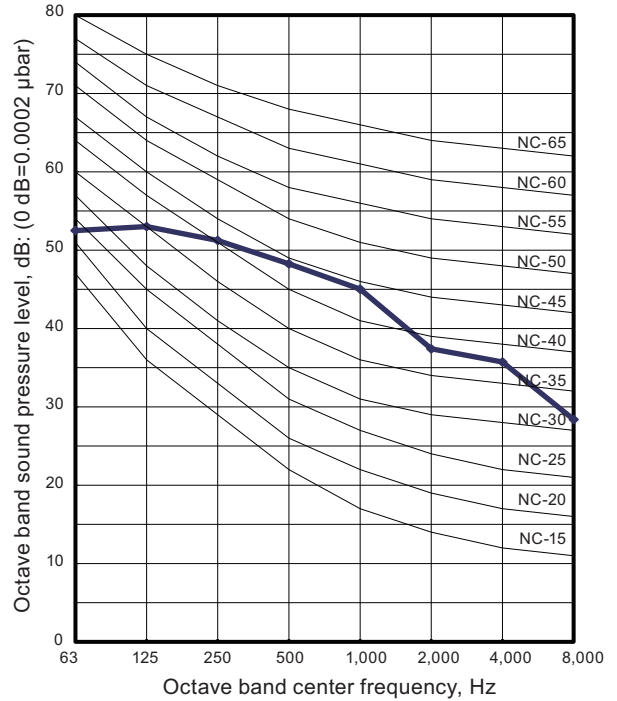

Model: AOUH24LPAS1

Cooling

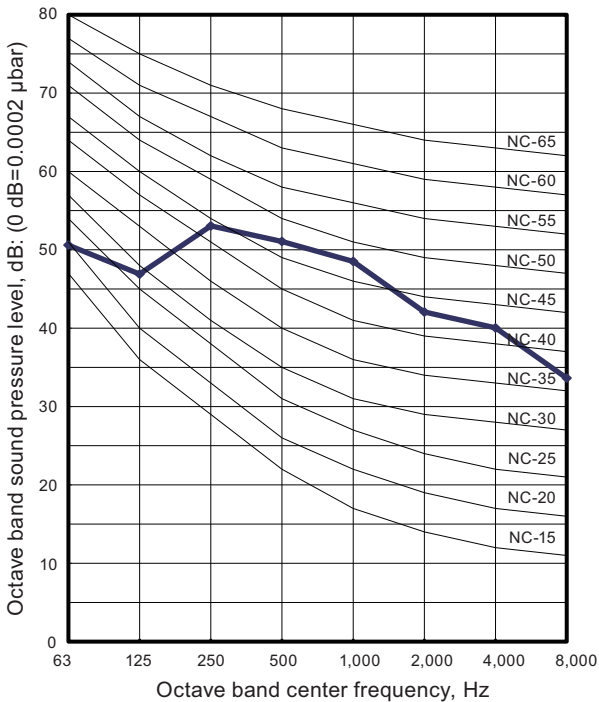

Heating

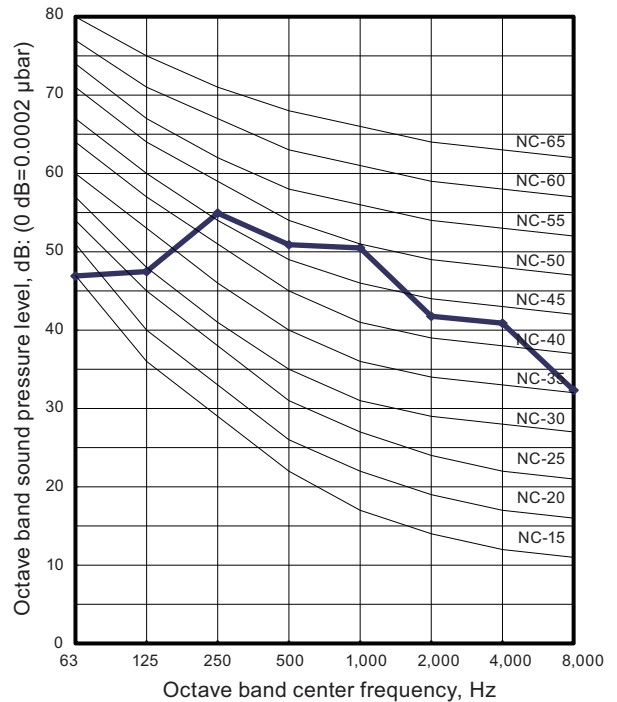

OUTDOOR UNIT
AOUH18-24LPAS1

OUTDOOR UNIT
AOUH18-24LPAS1

9-2. Sound level check point

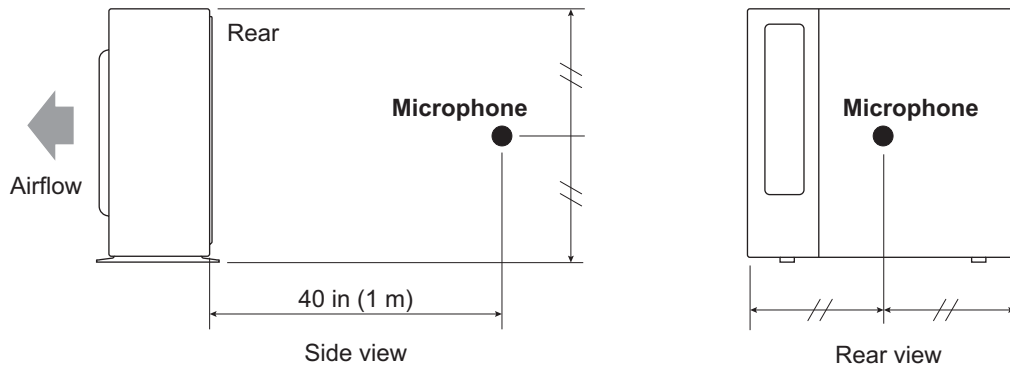

NOTE: Detailed shape of the actual outdoor unit might be slightly different from the one illustrated above.

10. Electrical characteristics

Model name			AOUH18LPAS1	AOUH24LPAS1
Power supply	Voltage		V	208/230~
	Frequency		Hz	60
MCA *1			A	14.7
Starting current			A	6.7
Wiring spec. *2	MAX. CKT. BKR *3		A	15
	Power cable		AWG	14
	Size		AWG	14
	Connection cable *4	Limited wiring length	ft (m)	69 (21)

*1: Minimum Circuit Ampacity (Calculation based on UL60335-2-40)

*2: Selected sample based on Japan Electrotechnical Standards and Codes Committee E0005. As the regulations of wire size and circuit breaker differ in each country or region, select appropriate devices complied to the regional standard.

*3: Maximum Circuit Breaker



*4: Limit voltage drop to less than 2%. If voltage drop is 2% or more, increase cable conductor size.

11. Safety devices

Type of protection	Protection form		Model	
			AOUH18LPAS1	AOUH24LPAS1
Circuit protection	Current fuse (Main PCB)		250 V, 20 A	
			250 V, 5 A	
Fan motor protection	Thermal protection program	Activate	257±18 °F (125±10 °C) Fan motor stop	
		Reset	248±18 °F (120±10 °C) Fan motor restart	
Compressor protection	Thermal protection program (Compressor temp.)	Activate	226 °F (108 °C) Compressor stop	
		Reset	After 3 minutes, and 176 °F (80 °C) or less Compressor restart	
	Thermal protection program (Discharge temp.)	Activate	230 °F (110 °C) Compressor stop	
		Reset	After 7 minutes Compressor restart	
	Thermal protection program (Outdoor temp.) (Only in COOL and DRY mode)	Activate	5 °F (-15 °C) Compressor stop	
		Reset	14 °F (-10 °C) Compressor restart	

12. Accessories

12-1. Models: AOUH18LPAS1 and AOUH24LPAS1

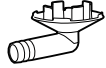
Part name	Exterior	Q'ty	Part name	Exterior	Q'ty
Installation manual		1	Cable tie		2
Drain pipe		1			