

AIR CONDITIONER

Duct type

DESIGN & TECHNICAL MANUAL

INDOOR



AMUG24LMAS
AMUG30LMAS
AMUG36LMAS
AMUG48LMAS

OUTDOOR



AOU24RGLX
AOU30RGLX



AOUG36LMAS1
AOUG48LMAS1

FUJITSU GENERAL LIMITED

Notices:

- Product specifications and design are subject to change without notice for future improvement.
- For further details, please check with our authorized dealer.

CONTENTS

Part 1. INDOOR UNIT	1
1. Specifications	2
2. Dimensions	4
2-1. Models: AMUG24LMAS, AMUG30LMAS, AMUG36LMAS, and AMUG48LMAS.....	4
2-2. Installation space requirement	5
3. Capacity table	7
3-1. Cooling capacity.....	7
3-2. Heating capacity	10
4. Fan performance	12
4-1. Fan performance curve.....	12
4-2. Airflow	14
5. Operation noise (sound pressure)	18
5-1. Noise level curve.....	18
6. External input and output	20
6-1. External input.....	20
6-2. External output.....	22
6-3. Combination of external input and output.....	24
6-4. Details of function	27
7. Function settings	52
7-1. Function settings on indoor unit	52
7-2. Function settings by using remote controller	53
8. Accessories	61
8-1. Models: AMUG24LMAS, AMUG30LMAS, AMUG36LMAS, and AMUG48LMAS.....	61
9. Optional parts	62
9-1. Controllers	62
9-2. Others	63

CONTENTS (continued)

Part 2. OUTDOOR UNIT	65
1. Specifications	66
2. Dimensions	68
2-1. Models: AOU24RGLX and AOU30RGLX	68
2-2. Models: AOUG36LMAS1 and AOUG48LMAS1	69
3. Installation space	70
3-1. Models: AOU24RGLX and AOU30RGLX	70
3-2. Models: AOUG36LMAS1 and AOUG48LMAS1	73
4. Refrigerant circuit	77
4-1. Models: AOU24RGLX and AOU30RGLX	77
4-2. Models: AOUG36LMAS1 and AOUG48LMAS1	78
5. Wiring diagrams	79
5-1. Models: AOU24RGLX and AOU30RGLX	79
5-2. Models: AOUG36LMAS1 and AOUG48LMAS1	80
6. Capacity compensation rate for pipe length and height difference	81
6-1. Models: AOU24RGLX and AOU30RGLX	81
6-2. Models: AOUG36LMAS1 and AOUG48LMAS1	82
7. Additional charge calculation	83
7-1. Models: AOU24RGLX and AOU30RGLX	83
7-2. Models: AOUG36LMAS1 and AOUG48LMAS1	83
8. Airflow	84
8-1. Model: AOU24RGLX.....	84
8-2. Model: AOU30RGLX.....	84
8-3. Model: AOUG36LMAS1	84
8-4. Model: AOUG48LMAS1	85
9. Operation noise (sound pressure)	86
9-1. Noise level curve.....	86
9-2. Sound level check point	88
10. Electrical characteristics	89
11. Safety devices	90
12. Function settings	91
12-1.Setting methods	91
12-2.Outdoor unit low noise operation function (option).....	94
13. Test	95
13-1.Test run.....	95
13-2.Error code	97
13-3.Pump down	100
14. Accessories	102
14-1.Models: AOU24RGLX and AOU30RGLX	102
14-2.Models: AOUG36LMAS1 and AOUG48LMAS1	102

Part 1. INDOOR UNIT

DUCT TYPE:

AMUG24LMAS

AMUG30LMAS

AMUG36LMAS

AMUG48LMAS

1. Specifications

Type				Duct							
				Inverter heat pump							
Model name				AMUG24LMAS	AMUG30LMAS	AMUG36LMAS	AMUG48LMAS				
Power supply				208/230 V ~ 60 Hz							
Power supply intake				Outdoor unit							
Available voltage range				187—253 V							
Capacity	Cooling	95 °FDB (Outdoor temp.)	Rated	kW	7.03	8.79	10.55	13.36			
				Btu/h	24,000	30,000	36,000	45,600			
			Min.—Max.	kW	1.58—8.50	2.81—10.76	3.81—11.14	3.81—14.07			
				Btu/h	5,400—29,000	9,600—35,000	13,000—38,000	13,000—48,000			
			82 °FDB (Outdoor temp.)	Min.—Max.	kW	3.17—9.01	3.17—11.20	3.96—12.20	3.96—15.20		
				Btu/h	10,800—30,700	10,800—38,000	13,500—41,700	13,500—51,800			
	Heating	47 °FDB (Outdoor temp.)	Rated	kW	7.91	9.38	12.31	15.53			
				Btu/h	27,000	32,000	42,000	53,000			
			Min.—Max.	kW	1.58—9.50	2.70—11.43	3.22—15.24	3.22—15.83			
				Btu/h	5,400—32,400	9,200—39,000	11,000—52,000	11,000—54,000			
			17 °FDB (Outdoor temp.)	Rated	kW	5.48	6.62	8.91	11.58		
				Btu/h	18,700	22,600	30,400	39,500			
	Min.—Max.	kW	1.08—6.57	1.88—8.06	2.32—11.16	2.37—11.79					
Input power	Cooling	95 °FDB (Outdoor temp.)	Rated	kW	2.00	2.97	3.18	5.56			
				Min.—Max.	0.55—2.22	0.61—3.41	0.85—3.52	0.85—5.94			
			82 °FDB (Outdoor temp.)	Min.—Max.	0.50—1.90	0.50—2.97	0.60—3.05	0.60—5.28			
	Heating	47 °FDB (Outdoor temp.)	Rated	kW	2.48	3.02	3.82	5.35			
				Min.—Max.	0.55—3.47	0.57—4.16	0.67—5.39	0.67—5.42			
			17 °FDB (Outdoor temp.)	Rated	kW	1.93	2.43	3.23	4.54		
		Min.—Max.	0.43—3.29	0.46—3.34	0.57—5.20	0.57—5.23					
	5 °FDB (Outdoor temp.)	Min.—Max.	0.54—3.22	0.47—3.26	0.60—4.77	0.60—4.80					
		Lower limit (Outdoor temp.)	Min.—Max.	0.48—3.20	0.42—3.24	0.59—4.28	0.59—4.30				
Fan	Fan		HIGH	W	106.9	136.3	204.3	412.4			
			MED	67.4	96.3	63.4	118.2				
			LOW	50.6	57.7	42.1	73.1				
			QUIET	19.7	22.7	31.0	38.5				
Current	Cooling	Heating	Rated	A	8.8	13.0	14.0	24.4			
				10.9	13.3	16.8	23.5				
EER	Cooling		kW/kW	3.52	2.96	3.31	2.40				
			Btu/hW	12.0	10.1	11.3	8.20				
COP	Heating		kW/kW	3.19	3.11	3.22	2.90				
			Btu/hW	10.9	10.6	11.0	9.9				
SEER	Cooling		Btu/hW	19.0	18.5	18.0	17.0				
HSPF	Heating			10.7	10.3	10.2					
Power factor	Cooling	Heating		%	98.8	99.2	98.8	99.1			
					98.9	98.7	98.9	99.0			
Moisture removal				pints/h (L/h)	4.6 (2.2)	7.2 (3.4)	9.3 (4.4)				
Maximum operating current *1	Cooling	Heating		A	15.6		32.4				
					16.1		32.4				
Fan	Airflow rate	Cooling	HIGH	CFM (m³/h)	800 (1,359)		870 (1,478)	1,200 (2,039)	1,640 (2,786)		
					MED	670 (1,138)		730 (1,240)	740 (1,257)	1,020 (1,733)	
						LOW	590 (1,002)				
							QUIET	310 (527)		490 (833)	590 (1,002)
								800 (1,359)		870 (1,478)	1,200 (2,039)
		Heating	HIGH	670 (1,138)		730 (1,240)	740 (1,257)	1,020 (1,733)			
				MED	590 (1,002)						
					LOW	310 (527)		490 (833)	590 (1,002)		
						QUIET	800 (1,359)		870 (1,478)	1,200 (2,039)	1,640 (2,786)
							670 (1,138)		730 (1,240)	740 (1,257)	1,020 (1,733)
Type × Q'ty				Sirocco fan × 1							
Static pressure range				inWG (Pa)	0.1 to 1 (20 to 250)						
Sound pressure level *2	Cooling	HIGH	dB (A)	40		42	41	48			
				MED	34		37	30	36		
					LOW	32		33	27	31	
						QUIET	26		28	24	25
							37		39	40	47
	Heating	HIGH	33		36	35	37				
			MED	31		32	28	32			
				LOW	25						
					QUIET	25		26	29		
						31		32	28	32	
Heat exchanger type	Dimensions (H × W × D)		in (mm)	16 × 17- 2/16 × 1- 8/16		32 × 17- 2/16 × 1- 8/16					
	Fin pitch		FPI	(406 × 435 × 38)		(813 × 435 × 38)					
	Rows × Stages			16		15					
	Pipe type			2 × 48		2 × 64					
	Fin type			Aluminum							
Enclosure	Material		Aluminum								
	Color		Steel								
Dimensions (H × W × D)	Net	in (mm)	42- 8/16 × 21 × 21- 11/16		57 × 21 × 21- 11/16						
	Gross		(1,080 × 533 × 551)		(1,448 × 533 × 551)						
Weight	Net	lb (kg)	42- 12/16 × 24 × 25- 5/16		57- 2/16 × 23 × 26- 8/16						
	Gross		(1,086 × 610 × 643)		(1,451 × 584 × 673)						
Connection pipe	Size	in (mm)	Ø 3/8 (Ø 9.52)								
	Method		Ø 5/8 (Ø 15.88)								
Drain port	Size	in (mm)	Flare	Flare	Flare	Flare					
			Ø 3/4 (19) [O.D.]	Ø 3/4 (19) [O.D.]	Ø 3/4 (19) [O.D.]	Ø 3/4 (19) [O.D.]					

Type			Duct			
			Inverter heat pump			
Model name			AMUG24LMAS	AMUG30LMAS	AMUG36LMAS	AMUG48LMAS
Operation range	Cooling	°F (°C)	64 to 90 (18 to 32)			
		%RH	80 or less	80 or less	—	—
	Heating	°F (°C)	60 to 86 (16 to 30)			
NOTES:						
<ul style="list-style-type: none"> • Specifications are based on the following conditions: <ul style="list-style-type: none"> – Cooling: Indoor temperature of 80 °FDB/67 °FWB (26.67 °CDB/19.44 °CWB), and outdoor temperature of 95 °FDB/75 °FWB (35 °CDB/23.9 °CWB). – Heating: Indoor temperature of 70 °FDB/59 °FWB (21.11 °CDB/15 °CWB), and outdoor temperature of 47 °FDB/43 °FWB (8.33 °CDB/6.11 °CWB). – Pipe length: 24 ft 7 in (7.5 m), Height difference: 0 ft (0 m). (Between outdoor unit and indoor unit.) – Standard static pressure: 0.18 in.WG (45 Pa): 24 model, 0.23 in.WG (58 Pa): 30, and 36 model, 0.28 in.WG (70 Pa): 48 model • Protective function might work when using it outside the operation range. • *1: Maximum current: <ul style="list-style-type: none"> – The maximum value when operated within the operation range. – The total current of indoor unit and outdoor unit. • *2: Sound pressure level: <ul style="list-style-type: none"> – Measured values in manufacturer's anechoic chamber. – Because of the surrounding sound environment, the sound levels measured in actual installation conditions might be higher than the specified values here. 						

2. Dimensions

2-1. Models: AMUG24LMAS, AMUG30LMAS, AMUG36LMAS, and AMUG48LMAS

Unit: in (mm)

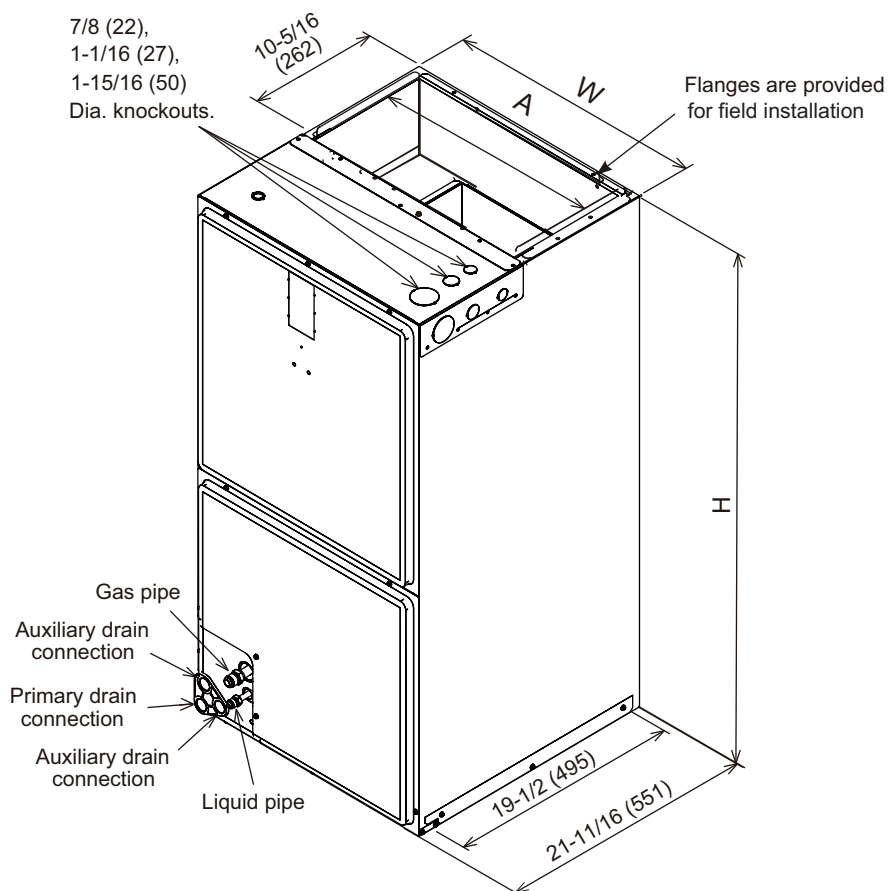

Model	Dimension (Unit: in (mm))		
	A (Supply duct)	W (Unit width)	H (Unit height)
AMUG24LMAS AMUG30LMAS	$19\text{-}1/2$ (495)	21 (533)	$42\text{-}1/2$ (1,080)
AMUG36LMAS AMUG48LMAS	$19\text{-}1/2$ (495)	21 (533)	57 (1,448)

2-2. Installation space requirement

Provide sufficient installation space for product safety.

(Top side)

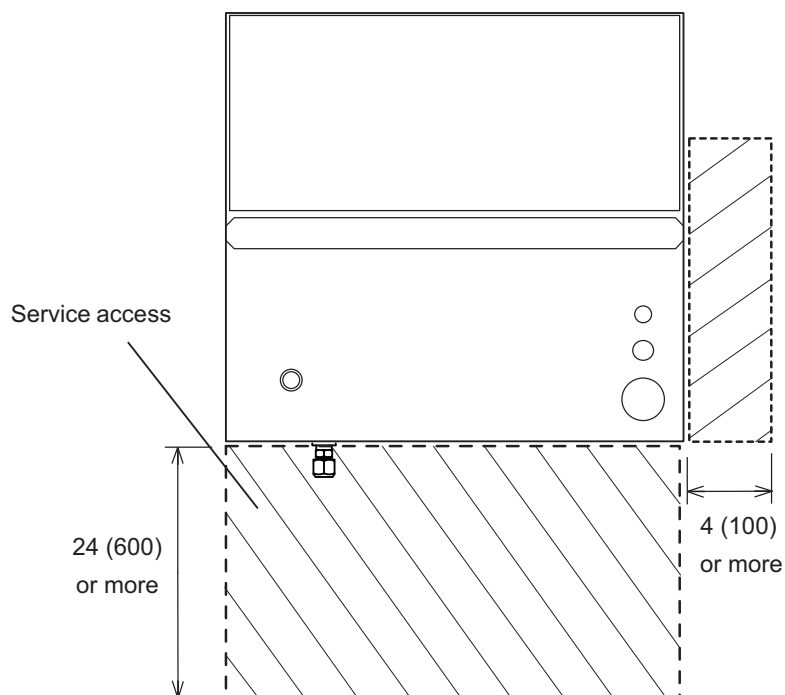

For installation method, the following 4 patterns

- **Pattern A: Vertical installation, air intake port at the bottom**

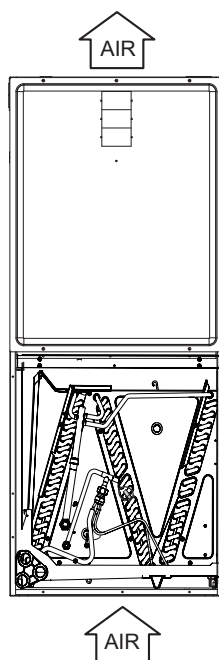

- **Pattern B: Horizontal installation, air intake port at the right**

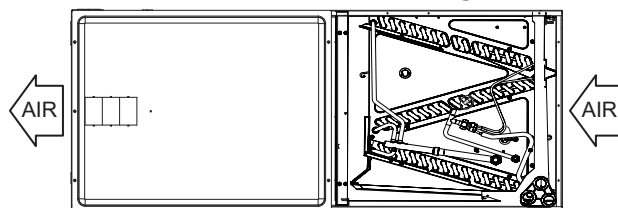

- **Pattern C: Vertical installation, air intake port at the top**
Reversing the heat exchanger and reattaching the thermistor are required

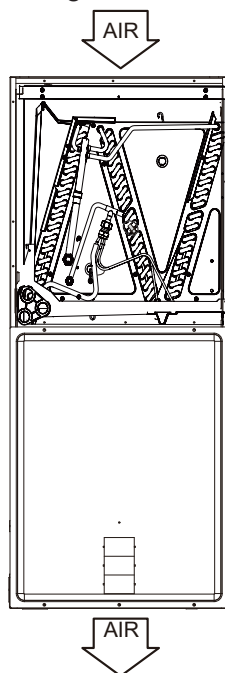

- **Pattern D: Horizontal installation, air intake port at the left**
Reversing the heat exchanger and reattaching the thermistor are required

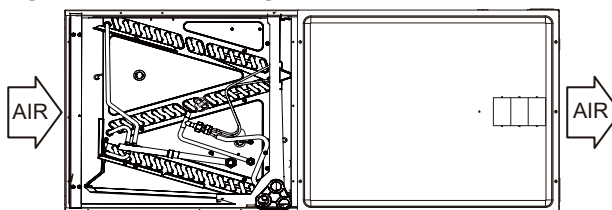

3. Capacity table

Capacity tables show each of following values calculated based on the outdoor temperature and the indoor temperature, under given Airflow Rate (AFR):

For cooling capacity: Total Capacity (TC), Sensible Heat Capacity (SHC), and Input Power (IP)

For heating capacity: Total Capacity (TC) and Input Power (IP)

3-1. Cooling capacity

■ Model: AMUG24LMAS

AFR	CFM	800
-----	-----	-----

Outdoor temperature	Indoor temperature																	
	64			70			75			80			85			90		
	°FDB			°FWB			°FDB			°FWB			°FDB			°FWB		
	TC	SHC	IP	TC	SHC	IP	TC	SHC	IP	TC	SHC	IP	TC	SHC	IP	TC	SHC	IP
	kBTu/h			kW			kBTu/h			kW			kBTu/h			kW		
-5	5.43	5.43	2.54	5.66	5.66	2.67	6.05	6.05	2.74	6.45	6.45	2.88	7.55	7.55	2.90	8.10	8.10	2.92
5	10.89	10.89	1.99	11.17	11.17	2.12	11.85	11.85	2.20	12.94	12.94	2.26	14.37	14.37	2.29	16.24	16.24	2.29
14	14.98	13.21	1.60	16.05	13.59	1.72	17.10	14.24	1.81	18.27	15.24	1.89	19.50	16.44	1.94	20.90	18.03	1.97
32	20.95	16.64	1.06	23.21	17.15	1.18	24.81	17.77	1.28	26.10	18.62	1.37	27.07	19.51	1.45	27.78	20.66	1.53
41	22.83	17.73	0.92	25.49	18.29	1.04	27.27	18.91	1.13	28.62	19.69	1.23	29.50	20.51	1.32	30.00	21.51	1.41
50	23.97	18.41	0.87	26.89	19.01	0.98	28.80	19.63	1.07	30.19	20.35	1.16	31.04	21.14	1.25	31.40	22.06	1.35
59	24.37	18.68	0.91	27.42	19.31	1.01	29.40	19.94	1.09	30.83	20.60	1.18	31.67	21.41	1.26	32.00	22.29	1.35
67	24.12	18.58	1.02	27.17	19.22	1.10	29.17	19.86	1.17	30.61	20.48	1.25	31.48	21.35	1.33	31.85	22.23	1.41
77	22.97	17.98	1.25	25.88	18.64	1.31	27.83	19.30	1.37	29.29	19.86	1.43	30.24	20.87	1.49	30.74	21.82	1.56
86	21.16	17.02	1.54	23.81	17.67	1.60	25.65	18.36	1.64	27.11	18.87	1.68	28.17	20.06	1.72	28.90	21.11	1.76
95	18.61	15.64	1.93	20.86	16.27	1.96	22.54	17.00	1.98	24.00	17.48	2.00	25.20	18.88	2.01	26.24	20.10	2.02
104	15.32	13.85	2.40	17.05	14.46	2.41	18.50	15.22	2.42	19.95	15.67	2.43	21.34	17.35	2.44	22.77	18.78	2.45
115	10.31	10.31	3.10	11.21	11.21	3.11	12.32	12.32	3.12	13.74	12.90	3.12	15.40	14.99	3.13	17.43	16.74	3.14

AFR	m ³ /h	1,359
-----	-------------------	-------

Outdoor temperature	Indoor temperature																	
	17.8			21.1			23.9			26.7			29.4			32.2		
	°CDB			°CWB			°CDB			°CWB			°CDB			°CWB		
	TC	SHC	IP	TC	SHC	IP	TC	SHC	IP	TC	SHC	IP	TC	SHC	IP	TC	SHC	IP
	kW			kW			kW			kW			kW			kW		
-20.6	1.59	1.59	2.54	1.66	1.66	2.67	1.77	1.77	2.74	1.89	1.89	2.88	2.21	2.21	2.90	2.37	2.37	2.92
-15	3.19	3.19	1.99	3.27	3.27	2.12	3.47	3.47	2.20	3.79	3.79	2.26	4.21	4.21	2.29	4.76	4.76	2.29
-10	4.39	3.87	1.60	4.71	3.98	1.72	5.01	4.17	1.81	5.35	4.47	1.89	5.72	4.82	1.94	6.13	5.28	1.97
0	6.14	4.88	1.06	6.80	5.03	1.18	7.27	5.21	1.28	7.65	5.46	1.37	7.93	5.72	1.45	8.14	6.06	1.53
5	6.69	5.20	0.92	7.47	5.36	1.04	7.99	5.54	1.13	8.39	5.77	1.23	8.65	6.01	1.32	8.79	6.31	1.41
10	7.03	5.40	0.87	7.88	5.57	0.98	8.44	5.75	1.07	8.85	5.96	1.16	9.10	6.20	1.25	9.20	6.46	1.35
15	7.14	5.47	0.91	8.04	5.66	1.01	8.62	5.84	1.09	9.04	6.04	1.18	9.28	6.28	1.26	9.38	6.53	1.35
19.4	7.07	5.44	1.02	7.96	5.63	1.10	8.55	5.82	1.17	8.97	6.00	1.25	9.23	6.26	1.33	9.33	6.52	1.41
25	6.73	5.27	1.25	7.59	5.46	1.31	8.16	5.66	1.37	8.58	5.82	1.43	8.86	6.12	1.49	9.01	6.39	1.56
30	6.20	4.99	1.54	6.98	5.18	1.60	7.52	5.38	1.64	7.95	5.53	1.68	8.26	5.88	1.72	8.47	6.19	1.76
35	5.45	4.58	1.93	6.11	4.77	1.96	6.61	4.98	1.98	7.03	5.12	2.00	7.39	5.53	2.01	7.69	5.89	2.02
40	4.49	4.06	2.40	5.00	4.24	2.41	5.42	4.46	2.42	5.85	4.59	2.43	6.25	5.09	2.44	6.67	5.50	2.45
46.1	3.02	3.02	3.10	3.29	3.29	3.11	3.61	3.61	3.12	4.03	3.78	3.12	4.51	4.39	3.13	5.11	4.91	3.14

Model: AMUG30LMAS

AFR	CFM	870
-----	-----	-----

Outdoor temperature	Indoor temperature																	
	64			70			75			80			85			90		
	54			60			63			67			71			73		
°FDB	TC	SHC	IP	TC	SHC	IP	TC	SHC	IP	TC	SHC	IP	TC	SHC	IP	TC	SHC	IP
°FWB	kW			kW			kW			kW			kW			kW		
-5	6.78	6.78	3.78	7.07	7.07	3.97	7.56	7.56	4.07	8.06	8.06	4.28	9.43	9.43	4.30	10.12	10.12	4.34
5	13.61	13.61	2.96	13.96	13.96	3.15	14.82	14.82	3.27	16.17	16.17	3.36	17.96	17.96	3.40	20.31	20.31	3.40
14	18.72	16.52	2.37	20.07	16.98	2.56	21.37	17.80	2.69	22.83	19.06	2.80	24.38	20.55	2.88	26.13	22.53	2.93
32	26.19	20.80	1.58	29.02	21.43	1.76	31.01	22.21	1.90	32.63	23.28	2.04	33.84	24.39	2.16	34.72	25.83	2.27
41	28.54	22.16	1.37	31.86	22.86	1.54	34.08	23.64	1.69	35.77	24.61	1.82	36.88	25.63	1.96	37.50	26.89	2.09
50	29.96	23.01	1.30	33.61	23.77	1.46	36.00	24.54	1.59	37.74	25.44	1.73	38.80	26.42	1.86	39.26	27.57	2.00
59	30.47	23.35	1.35	34.28	24.14	1.49	36.76	24.92	1.62	38.53	25.75	1.75	39.59	26.76	1.88	40.00	27.86	2.01
67	30.15	23.22	1.51	33.97	24.03	1.63	36.46	24.83	1.74	38.27	25.60	1.86	39.35	26.69	1.97	39.81	27.79	2.10
77	28.71	22.48	1.85	32.35	23.30	1.95	34.79	24.12	2.04	36.61	24.83	2.13	37.80	26.09	2.22	38.43	27.27	2.31
86	26.44	21.27	2.29	29.76	22.09	2.37	32.06	22.95	2.43	33.89	23.59	2.49	35.21	25.07	2.55	36.12	26.39	2.61
95	23.26	19.55	2.87	26.08	20.34	2.91	28.17	21.24	2.94	30.00	21.85	2.97	31.50	23.61	2.99	32.80	25.13	3.00
104	19.15	17.31	3.57	21.31	18.07	3.58	23.13	19.02	3.60	24.94	19.59	3.61	26.67	21.69	3.62	28.46	23.47	3.63
115	12.89	12.89	4.60	14.02	14.02	4.61	15.40	15.40	4.63	17.17	16.13	4.64	19.25	18.74	4.65	21.79	20.93	4.67

AFR	m ³ /h	1,478
-----	-------------------	-------

Outdoor temperature	Indoor temperature																	
	17.8			21.1			23.9			26.7			29.4			32.2		
	12.2			15.6			17.2			19.4			21.7			22.8		
°CDB	TC	SHC	IP	TC	SHC	IP	TC	SHC	IP	TC	SHC	IP	TC	SHC	IP	TC	SHC	IP
°CWB	kW			kW			kW			kW			kW			kW		
-20.6	1.99	1.99	3.78	2.07	2.07	3.97	2.22	2.22	4.07	2.36	2.36	4.28	2.77	2.77	4.30	2.97	2.97	4.34
-15	3.99	3.99	2.96	4.09	4.09	3.15	4.34	4.34	3.27	4.74	4.74	3.36	5.26	5.26	3.40	5.95	5.95	3.40
-10	5.49	4.84	2.37	5.88	4.98	2.56	6.26	5.22	2.69	6.69	5.58	2.80	7.14	6.02	2.88	7.66	6.60	2.93
0	7.68	6.09	1.58	8.50	6.28	1.76	9.09	6.51	1.90	9.56	6.82	2.04	9.92	7.15	2.16	10.18	7.57	2.27
5	8.36	6.50	1.37	9.34	6.70	1.54	9.99	6.93	1.69	10.48	7.21	1.82	10.81	7.51	1.96	10.99	7.88	2.09
10	8.78	6.74	1.30	9.85	6.97	1.46	10.55	7.19	1.59	11.06	7.46	1.73	11.37	7.74	1.86	11.51	8.08	2.00
15	8.93	6.84	1.35	10.05	7.07	1.49	10.77	7.30	1.62	11.29	7.55	1.75	11.60	7.84	1.88	11.72	8.16	2.01
19.4	8.84	6.81	1.51	9.96	7.04	1.63	10.69	7.28	1.74	11.22	7.50	1.86	11.53	7.82	1.97	11.67	8.14	2.10
25	8.41	6.59	1.85	9.48	6.83	1.95	10.20	7.07	2.04	10.73	7.28	2.13	11.08	7.65	2.22	11.26	7.99	2.31
30	7.75	6.23	2.29	8.72	6.47	2.37	9.40	6.72	2.43	9.93	6.91	2.49	10.32	7.35	2.55	10.59	7.73	2.61
35	6.82	5.73	2.87	7.64	5.96	2.91	8.26	6.23	2.94	8.79	6.40	2.97	9.23	6.92	2.99	9.61	7.36	3.00
40	5.61	5.07	3.57	6.25	5.30	3.58	6.78	5.58	3.60	7.31	5.74	3.61	7.82	6.36	3.62	8.34	6.88	3.63
46.1	3.78	3.78	4.60	4.11	4.11	4.61	4.51	4.51	4.63	5.03	4.73	4.64	5.64	5.49	4.65	6.39	6.13	4.67

Model: AMUG36LMAS

AFR	CFM	1,200
-----	-----	-------

Outdoor temperature	Indoor temperature																	
	64			70			75			80			85			90		
	54			60			63			67			71			73		
°FDB	TC	SHC	IP	TC	SHC	IP	TC	SHC	IP	TC	SHC	IP	TC	SHC	IP	TC	SHC	IP
°FWB	kW			kW			kW			kW			kW			kW		
14	26.43	24.18	1.48	31.44	26.75	1.51	35.68	29.26	1.58	39.95	32.10	1.70	43.85	34.99	1.83	48.06	38.41	2.02
32	27.21	25.15	1.79	33.86	30.15	1.82	38.82	33.15	1.88	43.19	33.69	1.99	46.75	39.85	2.09	47.63	38.12	2.27
41	27.49	25.50	1.94	34.52	31.08	1.98	39.62	34.14	2.04	43.92	33.99	2.15	47.30	41.07	2.24	47.13	37.87	2.40
50	27.70	25.76	2.10	34.82	31.49	2.14	39.89	34.63	2.21	44.06	33.95	2.31	47.25	41.48	2.39	47.25	37.60	2.53
59	27.80	25.91	2.26	34.75	31.40	2.30	39.68	34.24	2.37	43.61	33.57	2.48	46.58	41.08	2.55	45.57	37.17	2.68
67	27.83	25.98	2.39	34.40	30.90	2.45	39.06	33.48	2.53	42.72	32.95	2.63	45.49	40.06	2.69	44.65	36.78	2.81
77	27.79	25.95	2.57	33.53	29.68	2.64	37.70	31.80	2.73	40.93	31.80	2.83	43.43	37.85	2.89	43.26	36.20	2.98
86	27.66	25.83	2.72	32.38	28.05	2.82	35.94	29.63	2.92	38.70	30.41	3.01	40.95	35.03	3.08	41.81	35.62	3.14
95	27.58	25.67	2.88	30.90	25.88	3.02	33.51	26.95	3.12	36.00	28.81	3.18	38.00	31.45	3.26	40.08	34.92	3.28
104	27.16	25.29	3.04	28.98	23.25	3.17	30.88	23.40	3.31	32.46	26.61	3.39	34.16	26.95	3.48	38.37	34.24	3.47
115	26.70	24.78	3.23	26.19	19.31	3.40	26.79	18.34	3.56	27.50	23.64	3.64	28.84	20.43	3.74	35.89	33.27	3.69

AFR	m ³ /h	2,039
-----	-------------------	-------

Outdoor temperature	Indoor temperature																	
	17.8			21.1			23.9			26.7			29.4			32.2		
	12.2			15.6			17.2			19.4			21.7			22.8		
°CDB	TC	SHC	IP	TC	SHC	IP	TC	SHC	IP	TC	SHC	IP	TC	SHC	IP	TC	SHC	IP
°CWB	kW			kW			kW			kW			kW			kW		
-10	7.75	7.09	1.48	9.22	7.84	1.51	10.46	8.57	1.58	11.71	9.41	1.70	12.85	10.26	1.83	14.09	11.26	2.02
0	7.98	7.37	1.79	9.92	8.84	1.82	11.38	9.71	1.88	12.66	9.87	1.99	13.70	11.68	2.09	13.96	11.17	2.27
5	8.06	7.47	1.94	10.12	9.11	1.98	11.61	10.01	2.04	12.87	9.96	2.15	13.86	12.04	2.24	13.81	11.10	2.40
10	8.12	7.55	2.10	10.21	9.23	2.14	11.69	10.15	2.21	12.91	9.95	2.31	13.85	12.16	2.39	13.85	11.02	2.53
15	8.15	7.60	2.26	10.19	9.20	2.30	11.63	10.04	2.37	12.78	9.84	2.48	13.65	12.04	2.55	13.36	10.89	2.68
19.4	8.16	7.61	2.39	10.08	9.06	2.45	11.45	9.81	2.53	12.52	9.66	2.63	13.33	11.74	2.69	13.08	10.78	2.81
25	8.14	7.61	2.57	9.83	8.70	2.64	11.05	9.32	2.73	12.00	9.32	2.83	12.73	11.09	2.89	12.68	10.61	2.98
30	8.11	7.57	2.72	9.49	8.22	2.82	10.53	8.69	2.92	11.34	8.91	3.01	12.00	10.27	3.08	12.26	10.44	3.14
35	8.08	7.52	2.88	9.06	7.59	3.02	9.82	7.90	3.12	10.55	8.44	3.18	11.14	9.22	3.26	11.75	10.24	3.28
40	7.96	7.41	3.04	8.49	6.81	3.17	9.05	6.86	3.31	9.51	7.80	3.39	10.01	7.90	3.48	11.24	10.04	3.47
46.1	7.82	7.26	3.23	7.67	5.66	3.40	7.85	5.38	3.56	8.06	6.93	3.64	8.45	5.99	3.74	10.52	9.75	3.69

Model: AMUG48LMAS

AFR	CFM	1,640
-----	-----	-------

		Indoor temperature																	
		64			70			75			80			85			90		
		54			60			63			67			71			73		
Outdoor temperature	°FDB	TC	SHC	IP	TC	SHC	IP	TC	SHC	IP	TC	SHC	IP	TC	SHC	IP	TC	SHC	IP
	°FWB	kBTu/h			kBTu/h			kBTu/h			kBTu/h			kBTu/h			kBTu/h		
	°FDB	kW			kW			kW			kW			kW			kW		
	14	33.48	30.60	2.58	39.83	33.85	2.64	45.19	37.02	2.77	50.60	40.61	2.97	55.54	44.28	3.20	60.88	48.60	3.53
	32	34.47	31.83	3.13	42.89	38.15	3.18	49.17	41.94	3.29	54.70	42.63	3.48	59.22	50.42	3.66	60.33	48.23	3.96
	41	34.82	32.27	3.40	43.72	39.33	3.46	50.19	43.20	3.57	55.63	43.00	3.75	59.91	51.96	3.91	59.70	47.91	4.19
	50	35.08	32.60	3.67	44.11	39.85	3.74	50.53	43.82	3.86	55.81	42.96	4.03	59.85	52.49	4.17	59.85	47.58	4.43
	59	35.21	32.79	3.94	44.02	39.74	4.03	50.26	43.33	4.15	55.24	42.47	4.33	59.00	51.98	4.45	57.72	47.03	4.68
	67	35.26	32.87	4.18	43.57	39.09	4.29	49.48	42.37	4.42	54.11	41.70	4.59	57.62	50.69	4.71	56.55	46.53	4.91
	77	35.20	32.83	4.49	42.48	37.55	4.62	47.75	40.24	4.78	51.84	40.23	4.94	55.01	47.90	5.06	54.79	45.81	5.21
86	35.03	32.68	4.76	41.01	35.49	4.92	45.52	37.50	5.10	49.02	38.47	5.26	51.87	44.32	5.38	52.96	45.07	5.48	
95	34.93	32.48	5.03	39.14	32.75	5.28	42.45	34.10	5.45	45.60	36.45	5.56	48.13	39.80	5.70	50.77	44.19	5.74	
104	34.40	32.01	5.31	36.70	29.41	5.55	39.12	29.60	5.79	41.12	33.68	5.94	43.27	34.10	6.08	48.60	43.33	6.07	
115	33.82	31.36	5.64	33.17	24.44	5.94	33.94	23.21	6.22	34.83	29.91	6.37	36.53	25.85	6.53	45.46	42.10	6.45	

AFR	m ³ /h	2,786
-----	-------------------	-------

		Indoor temperature																	
		17.8			21.1			23.9			26.7			29.4			32.2		
		12.2			15.6			17.2			19.4			21.7			22.8		
Outdoor temperature	°CDB	TC	SHC	IP	TC	SHC	IP	TC	SHC	IP	TC	SHC	IP	TC	SHC	IP	TC	SHC	IP
	°CWB	kW			kW			kW			kW			kW			kW		
	°CDB	kW			kW			kW			kW			kW			kW		
	-10	9.81	8.97	2.58	11.67	9.92	2.64	13.24	10.85	2.77	14.83	11.90	2.97	16.28	12.98	3.20	17.84	14.24	3.53
	0	10.10	9.33	3.13	12.57	11.18	3.18	14.41	12.29	3.29	16.03	12.49	3.48	17.36	14.78	3.66	17.68	14.14	3.96
	5	10.21	9.46	3.40	12.82	11.53	3.46	14.71	12.66	3.57	16.30	12.60	3.75	17.56	15.23	3.91	17.50	14.04	4.19
	10	10.28	9.55	3.67	12.93	11.68	3.74	14.81	12.84	3.86	16.36	12.59	4.03	17.54	15.38	4.17	17.54	13.94	4.43
	15	10.32	9.61	3.94	12.90	11.65	4.03	14.73	12.70	4.15	16.19	12.45	4.33	17.29	15.23	4.45	16.92	13.78	4.68
	19.4	10.33	9.63	4.18	12.77	11.46	4.29	14.50	12.42	4.42	15.86	12.22	4.59	16.89	14.86	4.71	16.57	13.64	4.91
	25	10.32	9.62	4.49	12.45	11.01	4.62	13.99	11.79	4.78	15.19	11.79	4.94	16.12	14.04	5.06	16.06	13.43	5.21
30	10.27	9.58	4.76	12.02	10.40	4.92	13.34	10.99	5.10	14.37	11.28	5.26	15.20	12.99	5.38	15.52	13.21	5.48	
35	10.24	9.52	5.03	11.47	9.60	5.28	12.44	9.99	5.45	13.36	10.68	5.56	14.11	11.66	5.70	14.88	12.95	5.74	
40	10.08	9.38	5.31	10.76	8.62	5.55	11.46	8.68	5.79	12.05	9.87	5.94	12.68	9.99	6.08	14.24	12.70	6.07	
46.1	9.91	9.19	5.64	9.72	7.16	5.94	9.95	6.80	6.22	10.21	8.77	6.37	10.71	7.58	6.53	13.32	12.34	6.45	

3-2. Heating capacity

NOTE: Values mentioned in the table are calculated based on the maximum capacity.

■ Model: AMUG24LMAS

AFR	CFM	800
-----	-----	-----

Outdoor temperature		Indoor temperature											
		°FDB		60		65		70		72		75	
		°FDB	°FWB	TC kBtu/h	IP kW	TC kBtu/h	IP kW	TC kBtu/h	IP kW	TC kBtu/h	IP kW	TC kBtu/h	IP kW
-5	-7	18.76	3.19	18.37	3.20	18.10	3.20	18.04	3.43	17.96	3.48		
5	3	20.64	3.19	19.72	3.20	19.80	3.22	20.13	3.41	20.95	3.48		
14	12	20.82	3.17	20.97	3.25	21.50	3.28	21.29	3.41	21.39	3.48		
23	19	23.22	3.20	23.87	3.28	23.95	3.35	23.90	3.42	23.51	3.49		
32	28	26.52	3.28	27.10	3.34	26.81	3.41	26.67	3.44	25.97	3.49		
41	37	30.74	3.42	30.68	3.44	30.09	3.45	29.59	3.47	28.76	3.49		
47	43	34.03	3.54	33.22	3.52	32.40	3.47	31.58	3.50	30.79	3.49		
50	47	35.86	3.61	34.59	3.58	33.79	3.47	32.66	3.52	31.87	3.49		
59	50	41.90	3.85	38.85	3.75	37.91	3.48	35.90	3.58	35.31	3.50		

AFR	m ³ /h	1,359
-----	-------------------	-------

Outdoor temperature		Indoor temperature											
		°CDB		15.6		18.3		21.1		22.2		23.9	
		°CDB	°CWB	TC kW	IP	TC kW	IP	TC kW	IP	TC kW	IP	TC kW	IP
-20.6	-21.7	5.50	3.19	5.38	3.20	5.30	3.20	5.29	3.43	5.26	3.48		
-15	-16.1	6.05	3.19	5.78	3.20	5.80	3.22	5.90	3.41	6.14	3.48		
-10	-11.1	6.10	3.17	6.14	3.25	6.30	3.28	6.24	3.41	6.27	3.48		
-5	-7.2	6.81	3.20	6.99	3.28	7.02	3.35	7.00	3.42	6.89	3.49		
0	-2.2	7.77	3.28	7.94	3.34	7.86	3.41	7.82	3.44	7.61	3.49		
5	2.8	9.01	3.42	8.99	3.44	8.82	3.45	8.67	3.47	8.43	3.49		
8.3	6.1	9.97	3.54	9.74	3.52	9.50	3.47	9.26	3.50	9.02	3.49		
10	8.3	10.51	3.61	10.14	3.58	9.90	3.47	9.57	3.52	9.34	3.49		
15	10	12.28	3.85	11.39	3.75	11.11	3.48	10.52	3.58	10.35	3.50		

■ Model: AMUG30LMAS

AFR	CFM	870
-----	-----	-----

Outdoor temperature		Indoor temperature											
		°FDB		60		65		70		72		75	
		°FDB	°FWB	TC kBtu/h	IP kW	TC kBtu/h	IP kW	TC kBtu/h	IP kW	TC kBtu/h	IP kW	TC kBtu/h	IP kW
-5	-7	22.58	3.23	22.11	3.24	21.70	3.24	21.70	3.48	21.62	3.52		
5	3	23.28	3.24	22.19	3.24	22.20	3.26	22.64	3.46	23.58	3.53		
14	12	25.06	3.21	25.23	3.30	25.86	3.33	25.61	3.45	25.75	3.53		
23	19	27.95	3.24	28.72	3.32	28.81	3.40	28.75	3.46	28.31	3.53		
32	28	31.92	3.33	32.61	3.38	32.26	3.46	32.08	3.49	31.27	3.54		
41	37	37.00	3.47	36.91	3.48	36.21	3.50	35.59	3.52	34.62	3.54		
47	43	40.95	3.59	39.98	3.57	39.00	3.52	38.03	3.55	37.05	3.54		
50	47	43.16	3.66	41.63	3.63	40.66	3.52	39.30	3.57	38.37	3.54		
59	50	50.43	3.91	46.75	3.80	45.61	3.53	43.19	3.63	42.52	3.55		

AFR	m ³ /h	1,478
-----	-------------------	-------

Outdoor temperature		Indoor temperature											
		°CDB		15.6		18.3		21.1		22.2		23.9	
		°CDB	°CWB	TC kW	IP	TC kW	IP	TC kW	IP	TC kW	IP	TC kW	IP
-20.6	-21.7	6.62	3.23	6.48	3.24	6.36	3.24	6.36	3.48	6.34	3.52		
-15	-16.1	6.82	3.24	6.50	3.24	6.51	3.26	6.63	3.46	6.91	3.53		
-10	-11.1	7.35	3.21	7.39	3.30	7.58	3.33	7.51	3.45	7.55	3.53		
-5	-7.2	8.19	3.24	8.42	3.32	8.44	3.40	8.43	3.46	8.30	3.53		
0	-2.2	9.36	3.33	9.56	3.38	9.45	3.46	9.40	3.49	9.16	3.54		
5	2.8	10.84	3.47	10.82	3.48	10.61	3.50	10.43	3.52	10.15	3.54		
8.3	6.1	12.00	3.59	11.72	3.57	11.43	3.52	11.14	3.55	10.86	3.54		
10	8.3	12.65	3.66	12.20	3.63	11.92	3.52	11.52	3.57	11.25	3.54		
15	10	14.78	3.91	13.70	3.80	13.37	3.53	12.66	3.63	12.46	3.55		

Model: AMUG36LMAS

AFR	CFM	1,200
-----	-----	-------

Outdoor temperature		°FDB	°FDB	Indoor temperature									
				60		65		70		72		75	
				TC	IP	TC	IP	TC	IP	TC	IP	TC	IP
				kBtu/h	kW	kBtu/h	kW	kBtu/h	kW	kBtu/h	kW	kBtu/h	kW
	-5	-7		32.94	4.07	31.05	4.11	28.83	4.28	28.44	4.31	28.78	4.45
	5	3		33.11	4.65	33.45	4.67	32.90	4.77	32.47	4.81	31.55	4.92
	14	12		33.99	5.02	36.37	5.02	36.75	5.11	36.41	5.15	35.15	5.25
	23	19		37.45	5.27	39.95	5.25	40.72	5.33	40.63	5.38	39.77	5.50
	32	28		43.50	5.38	44.23	5.35	44.83	5.45	45.15	5.51	45.43	5.66
	41	37		52.15	5.37	49.20	5.32	49.10	5.45	49.96	5.54	52.13	5.74
	47	43		59.28	5.29	52.84	5.24	52.00	5.39	53.30	5.50	57.11	5.74
	50	47		63.40	5.23	54.85	5.16	53.51	5.35	55.07	5.46	59.85	5.73
	59	50		77.24	4.96	61.19	4.88	58.07	5.13	60.48	5.27	68.62	5.64

AFR	m³/h	2,039
-----	------	-------

Outdoor temperature		°CDB	°CDB	Indoor temperature									
				15.6		18.3		21.1		22.2		23.9	
				TC	IP	TC	IP	TC	IP	TC	IP	TC	IP
				kW		kW		kW		kW		kW	
	-20.6	-21.7		9.65	4.07	9.10	4.11	8.45	4.28	8.33	4.31	8.43	4.45
	-15	-16.1		9.70	4.65	9.80	4.67	9.66	4.77	9.52	4.81	9.25	4.92
	-10	-11.1		9.96	5.02	10.66	5.02	10.77	5.11	10.67	5.15	10.30	5.25
	-5	-7.2		10.97	5.27	11.71	5.25	11.93	5.33	11.91	5.38	11.66	5.50
	0	-2.2		12.75	5.38	12.96	5.35	13.14	5.45	13.23	5.51	13.32	5.66
	5	2.8		15.29	5.37	14.42	5.32	14.39	5.45	14.64	5.54	15.28	5.74
	8.3	6.1		17.37	5.29	15.49	5.24	15.24	5.39	15.62	5.50	16.74	5.74
	10	8.3		18.58	5.23	16.08	5.16	15.68	5.35	16.14	5.46	17.54	5.73
	15	10		22.64	4.96	17.94	4.88	17.02	5.13	17.73	5.27	20.11	5.64

Model: AMUG48LMAS

AFR	CFM	1,640
-----	-----	-------

Outdoor temperature		°FDB	°FDB	Indoor temperature									
				60		65		70		72		75	
				TC	IP	TC	IP	TC	IP	TC	IP	TC	IP
				kBtu/h	kW	kBtu/h	kW	kBtu/h	kW	kBtu/h	kW	kBtu/h	kW
	-5	-7		34.20	4.09	32.25	4.13	29.94	4.30	29.53	4.34	29.88	4.47
	5	3		34.38	4.67	34.73	4.70	34.20	4.80	33.72	4.84	32.76	4.95
	14	12		35.34	5.05	37.77	5.05	38.43	5.14	37.81	5.18	36.50	5.28
	23	19		38.89	5.30	41.49	5.28	42.29	5.36	42.19	5.41	41.30	5.53
	32	28		45.71	5.41	45.93	5.38	46.83	5.48	46.89	5.54	47.18	5.69
	41	37		54.42	5.40	51.09	5.35	51.11	5.48	51.89	5.57	54.13	5.77
	47	43		61.56	5.32	54.87	5.26	54.00	5.42	55.35	5.53	59.30	5.78
	50	47		65.49	5.26	56.96	5.19	55.45	5.37	57.19	5.49	62.16	5.77
	59	50		78.91	4.99	63.55	4.90	59.83	5.16	62.80	5.30	71.26	5.67

AFR	m³/h	2,786
-----	------	-------

Outdoor temperature		°CDB	°CDB	Indoor temperature									
				15.6		18.3		21.1		22.2		23.9	
				TC	IP	TC	IP	TC	IP	TC	IP	TC	IP
				kW		kW		kW		kW		kW	
	-20.6	-21.7		10.02	4.09	9.45	4.13	8.77	4.30	8.66	4.34	8.76	4.47
	-15	-16.1		10.08	4.67	10.18	4.70	10.03	4.80	9.88	4.84	9.60	4.95
	-10	-11.1		10.36	5.05	11.07	5.05	11.26	5.14	11.08	5.18	10.70	5.28
	-5	-7.2		11.40	5.30	12.16	5.28	12.39	5.36	12.37	5.41	12.11	5.53
	0	-2.2		13.40	5.41	13.46	5.38	13.73	5.48	13.74	5.54	13.83	5.69
	5	2.8		15.95	5.40	14.97	5.35	14.98	5.48	15.21	5.57	15.87	5.77
	8.3	6.1		18.04	5.32	16.08	5.26	15.83	5.42	16.22	5.53	17.38	5.78
	10	8.3		19.19	5.26	16.69	5.19	16.25	5.37	16.76	5.49	18.22	5.77
	15	10		23.13	4.99	18.63	4.90	17.53	5.16	18.41	5.30	20.88	5.67

4. Fan performance

4-1. Fan performance curve

■ Model: AMUG24LMAS

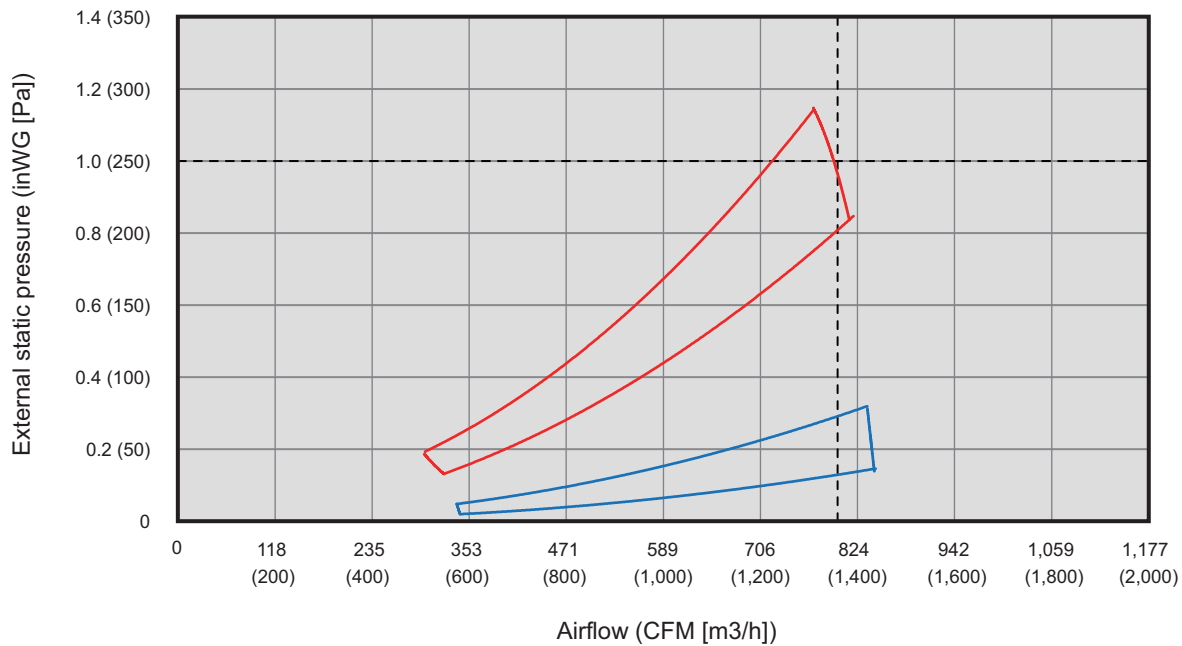

■ Model: AMUG30LMAS

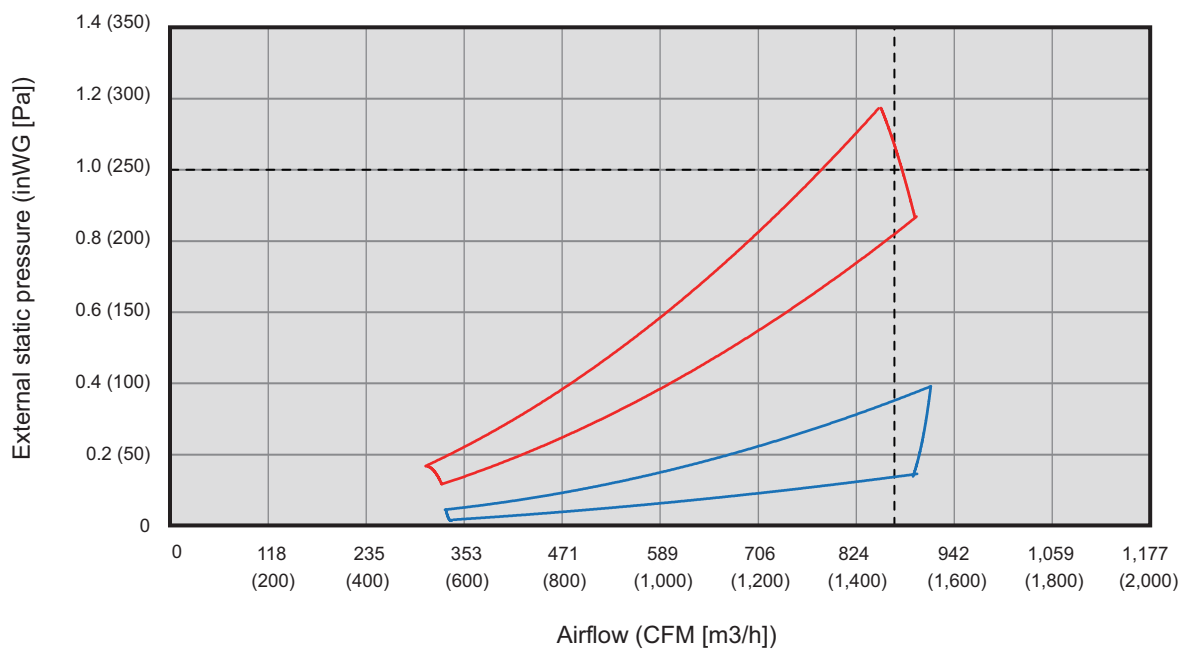

Model: AMUG36LMAS

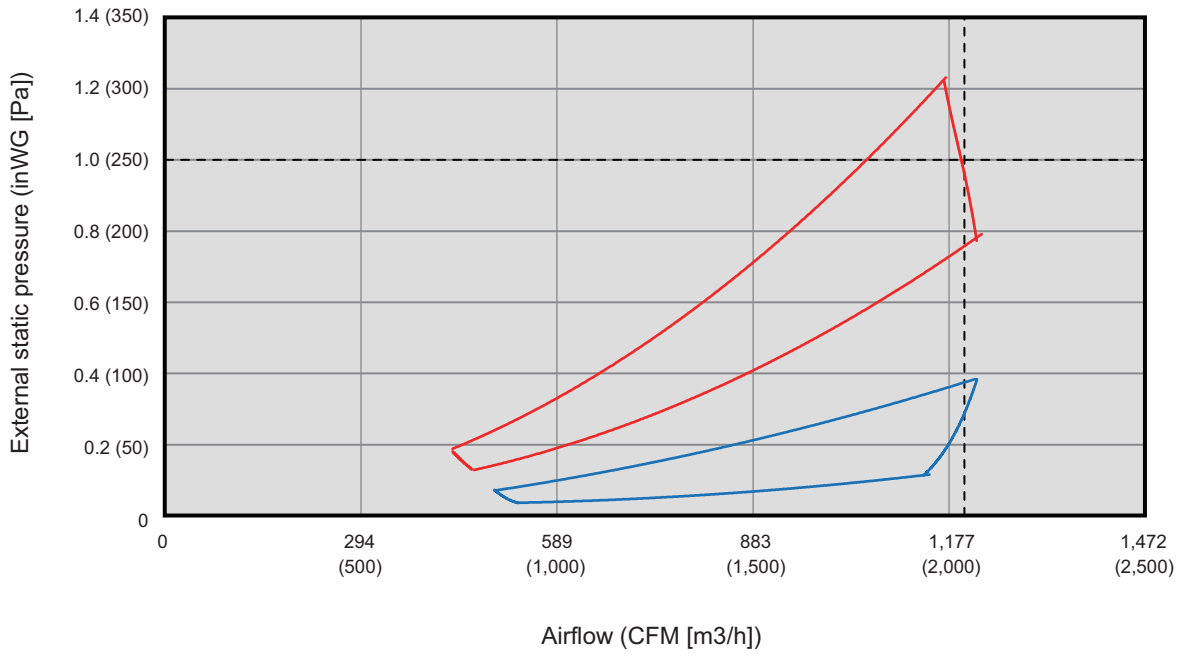

Model: AMUG48LMAS

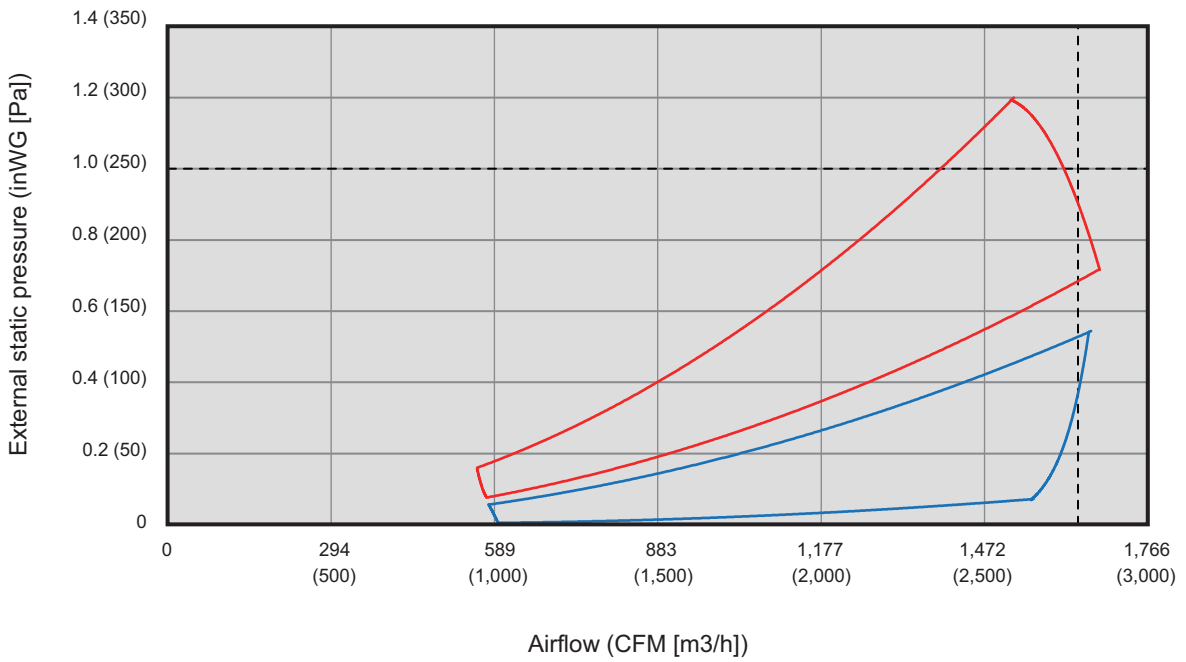

4-2. Airflow

■ Model: AMUG24LMAS

● Cooling

Fan speed	Airflow	
HIGH	m ³ /h	1,359
	l/s	378
	CFM	800
MED	m ³ /h	1,138
	l/s	316
	CFM	670
LOW	m ³ /h	1,002
	l/s	278
	CFM	590
QUIET	m ³ /h	527
	l/s	146
	CFM	310

● Heating

Fan speed	Airflow	
HIGH	m ³ /h	1,359
	l/s	378
	CFM	800
MED	m ³ /h	1,138
	l/s	316
	CFM	670
LOW	m ³ /h	1,002
	l/s	278
	CFM	590
QUIET	m ³ /h	527
	l/s	146
	CFM	310

■ Model: AMUG30LMAS

● Cooling

Fan speed	Airflow	
HIGH	m ³ /h	1,478
	l/s	411
	CFM	870
MED	m ³ /h	1,240
	l/s	345
	CFM	730
LOW	m ³ /h	1,002
	l/s	278
	CFM	590
QUIET	m ³ /h	527
	l/s	146
	CFM	310

● Heating

Fan speed	Airflow	
HIGH	m ³ /h	1,478
	l/s	411
	CFM	870
MED	m ³ /h	1,240
	l/s	345
	CFM	730
LOW	m ³ /h	1,002
	l/s	278
	CFM	590
QUIET	m ³ /h	527
	l/s	146
	CFM	310

■ Model: AMUG36LMAS

● Cooling

Fan speed	Airflow	
HIGH	m ³ /h	2,039
	l/s	566
	CFM	1,200
MED	m ³ /h	1,257
	l/s	349
	CFM	740
LOW	m ³ /h	1,002
	l/s	278
	CFM	590
QUIET	m ³ /h	833
	l/s	231
	CFM	490

● Heating

Fan speed	Airflow	
HIGH	m ³ /h	2,039
	l/s	566
	CFM	1,200
MED	m ³ /h	1,257
	l/s	349
	CFM	740
LOW	m ³ /h	1,002
	l/s	278
	CFM	590
QUIET	m ³ /h	833
	l/s	231
	CFM	490

■ Model: AMUG48LMAS

● Cooling

Fan speed	Airflow	
HIGH	m ³ /h	2,786
	l/s	774
	CFM	1,640
MED	m ³ /h	1,733
	l/s	481
	CFM	1,020
LOW	m ³ /h	1,393
	l/s	387
	CFM	820
QUIET	m ³ /h	1,002
	l/s	278
	CFM	590

● Heating

Fan speed	Airflow	
HIGH	m ³ /h	2,786
	l/s	774
	CFM	1,640
MED	m ³ /h	1,733
	l/s	481
	CFM	1,020
LOW	m ³ /h	1,393
	l/s	387
	CFM	820
QUIET	m ³ /h	1,002
	l/s	278
	CFM	590

5. Operation noise (sound pressure)

5-1. Noise level curve

Model: AMUG24LMAS

Cooling

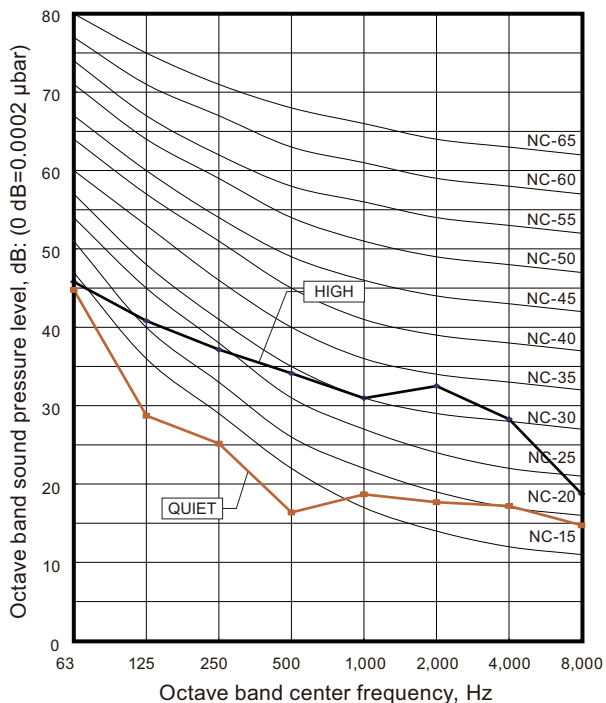

Heating

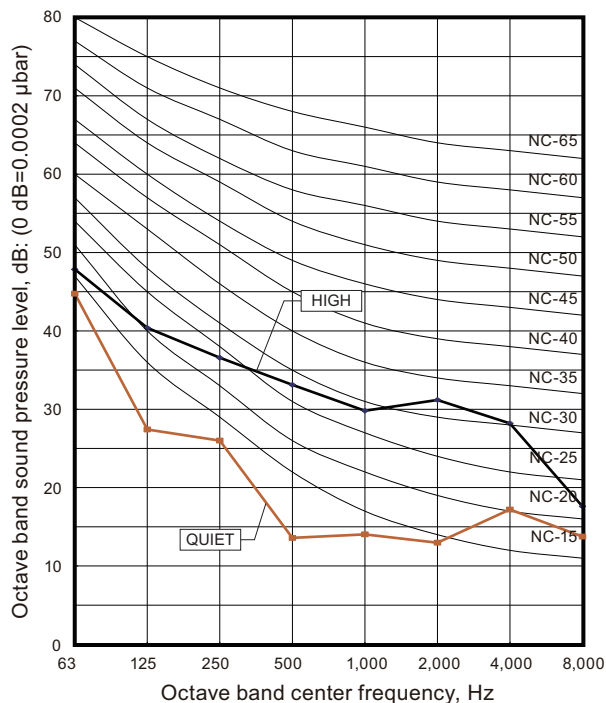

Model: AMUG30LMAS

Cooling

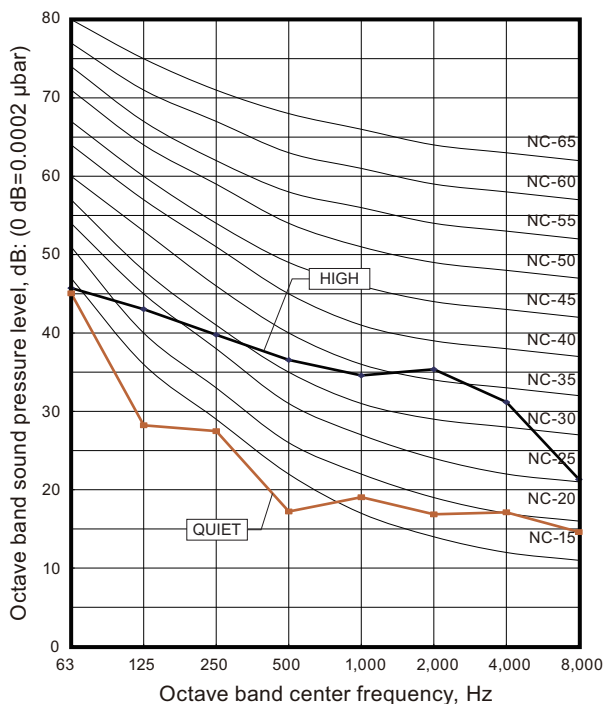

Heating

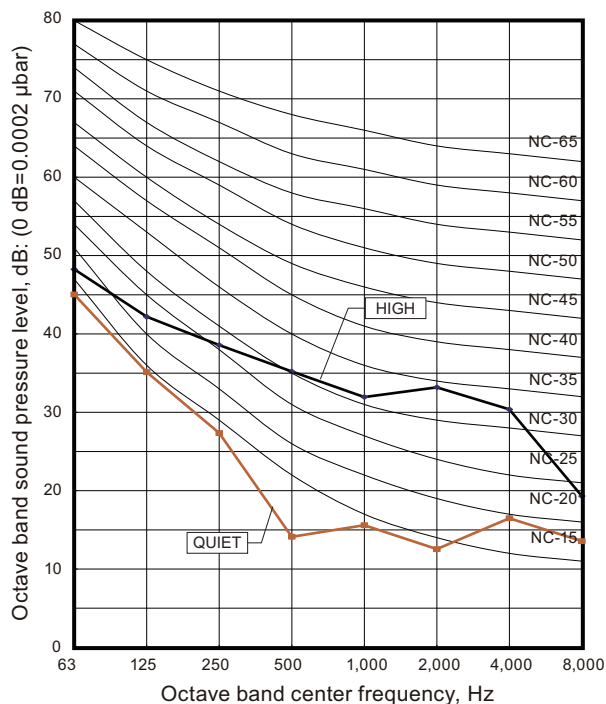

Model: AMUG36LMAS

Cooling

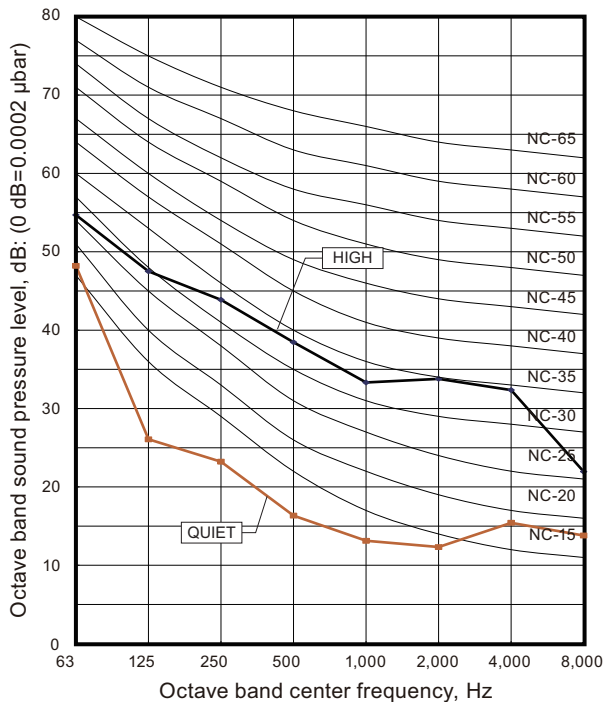

Heating

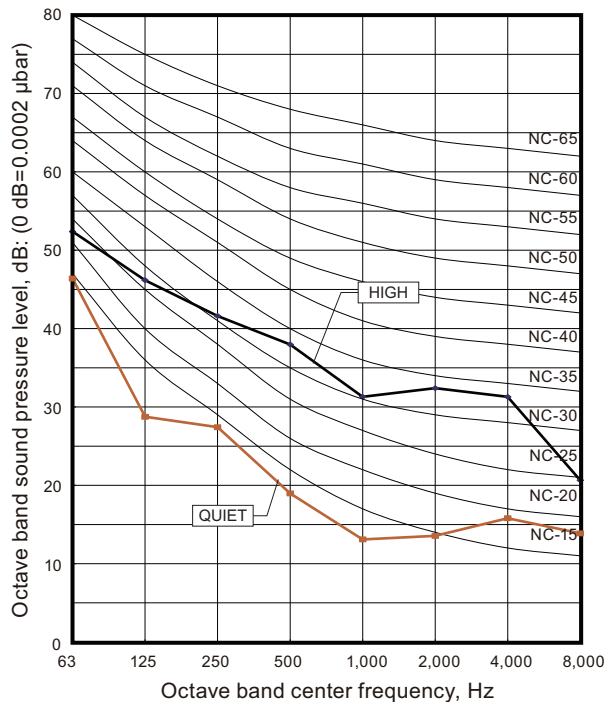

Model: AMUG48LMAS

Cooling

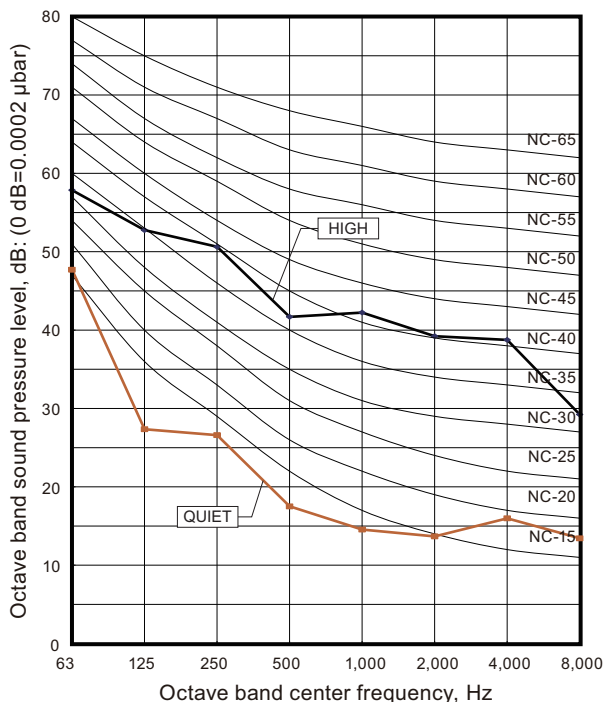

Heating

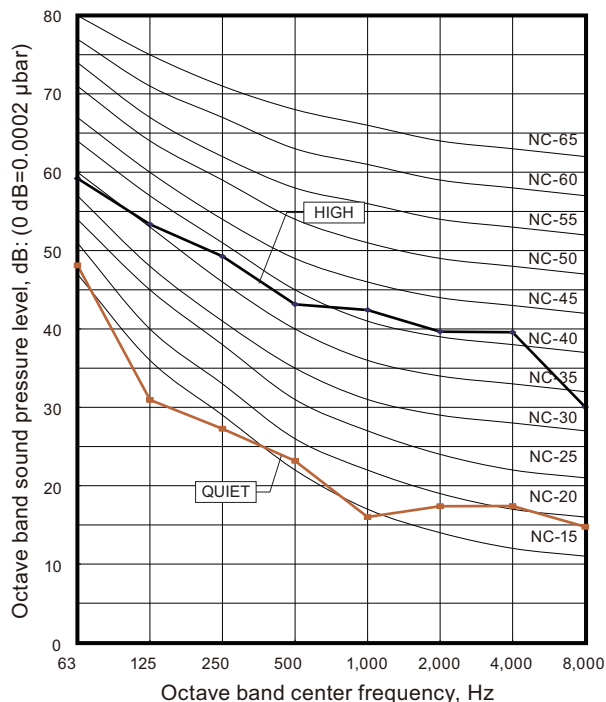

6. External input and output

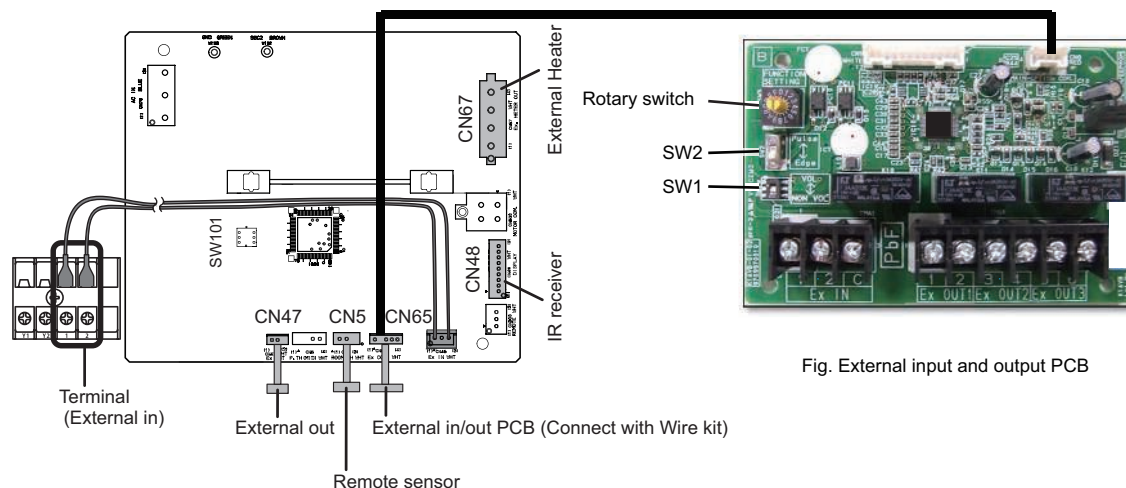

Fig. External input and output PCB

PCB	External input	External output	Connector	Input select	Input signal	External connect kit (Optional parts)
Indoor unit	Operation/Stop Forced stop	—	Terminal	Dry contact	Edge	—
	—	Operation status	CN47	—	—	UTY-XWZXZG
		Error status				
		Indoor unit fan operation status				
—	External heater output	CN47 CN67	—	—	—	
External input and output (UTY-XCSX)	Operation/Stop	—	Input 1/ Input 2	Dry contact/ Apply voltage	Edge/ Pulse	—
	Forced thermostat off		Input 1		Edge	
	—	Operation status	Output 1 Output 2 Output 3	—	—	—
		Error status				
Indoor unit fan operation status						
—	External heater output	—	—	—	—	

6-1. External input

- “Operation/Stop” mode or "Forced stop" mode can be selected with function setting of indoor unit.
- A twisted pair cable (22AWG) should be used. Maximum length of cable is 492 ft (150 m).
- The wire connection should be separate from the power cable line.

■ Indoor unit

Indoor unit functions such as Operation/Stop can be done by using indoor unit terminals.

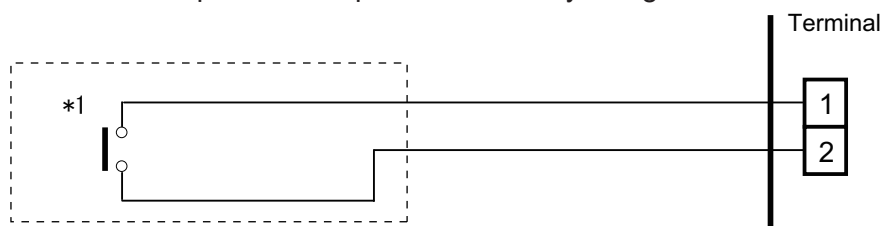

*1: The switch can be used on the following condition: DC 12 V to 24 V, 1 mA to 15 mA.

External input and output PCB

The indoor unit Operation/Stop can be set by using the input terminal on the PCB.

Input select

Use either one of these types of terminals according to the application. (Both types of terminals cannot be used simultaneously.)

- Dry contact

In case of internal power supply, set the slide switch of SW1 to "NON VOL" side.

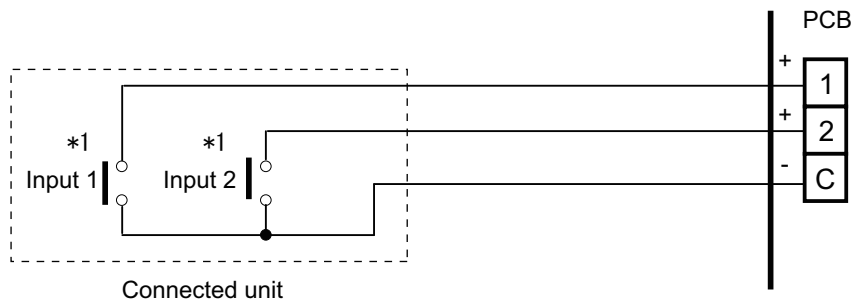

*1: The switches can be used on the following condition: DC 12 V to 24 V, 1 mA to 15 mA.

- Apply voltage

In case of external power supply, set the slide switch of SW1 to "VOL" side.

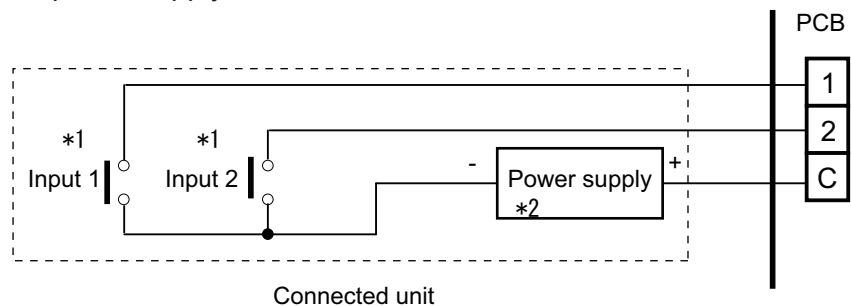

*1: The switches can be used on the following condition: DC 12 V to 24 V, 1 mA to 15 mA.

*2: Make the power supply DC 12 V to 24 V 10 mA or more.

6-2. External output

Use an external output cable with appropriate external dimension, depending on the number of cables to be installed.

Indoor unit

- A twisted pair cable (22AWG) should be used. Maximum length of cable is 82 ft (25 m).
- Output voltage: High DC 12 V \pm 2 V, Low 0 V.
- Permissible current: 50 mA
- For details, refer to Chapter 6-3. "[Combination of external input and output](#)" on page 24.

When indicator, etc. are connected directly

Example: Function setting 60 is set to "00"

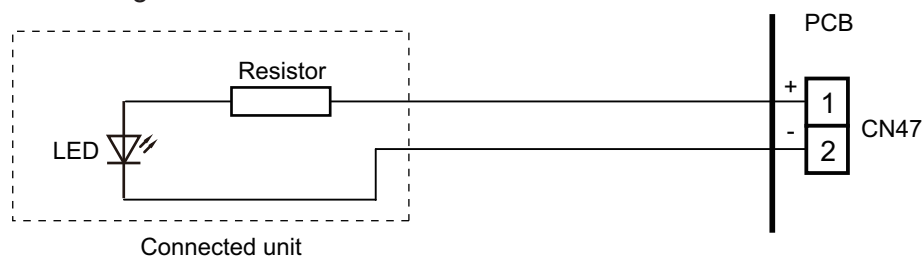

When connecting with a device equipped with a power supply

Example: Function setting 60 is set to "00"

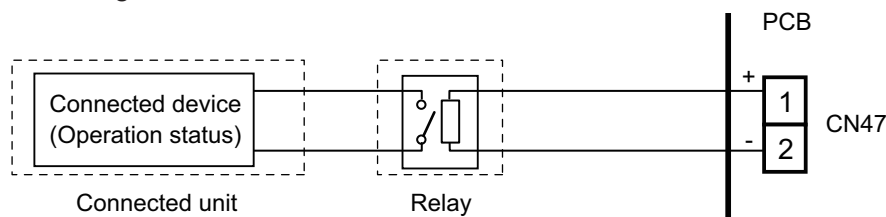

When connecting with a external heater

Output voltage:	Heater ON: AC24V \pm 25% Heater OFF: Open
Permissible current:	500mA

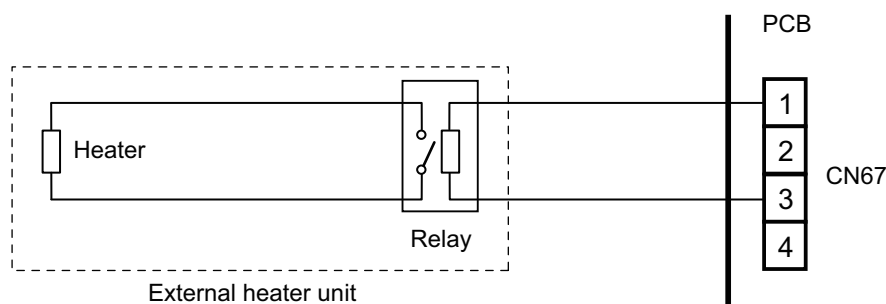

External input and output PCB

- A twisted pair cable (22AWG) should be used.
- Permissible voltage and current: DC 5 V to 30 V / 3 A, AC 30 V to 250 V / 3 A
- For details, refer to Chapter 6-3. "[Combination of external input and output](#)" on page 24.

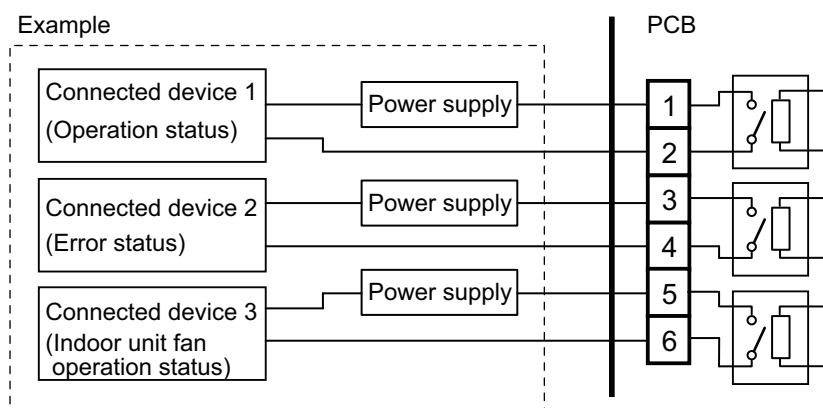

6-3. Combination of external input and output

By combining the function setting of the indoor unit and rotary switch setting of the External input and output PCB, you can select various combinations of functions.

Combination examples of external input and output are as follows:

Mode	Function setting	External input and output PCB (Rotary SW)	External input			
			Indoor unit Input	External input and output PCB		
			Terminal	Input 1	Input 2	Signal type
0-1	60-00	1	Operation/Stop (Function setting 46-00) or Forced stop (Function setting 46-02)	Operation/Stop	Not available	Edge
				Operation	Stop	Pulse
0-2	60-00	2		Forced Thermostat OFF	Not available	Edge
1	60-01	3		Mechanical cooling Off		
2	60-02	4		Forced thermostat Off		
3	60-03	5		Mechanical cooling On		
4	60-04	6		Mechanical cooling On		
5	60-05	7		Forced thermostat Off		
6	60-06	8		Forced thermostat Off		
7	60-07	9		Mechanical cooling Off		
8	60-08	A		Forced thermostat Off		
9	60-09	B		Forced Thermostat OFF		
10	60-10	C	Forced Thermostat OFF			
11	60-11	D	Forced Thermostat OFF			
12	60-12	D	Forced Thermostat OFF			

Mode	Function setting	External input and output PCB (Rotary SW)	External output			
			Indoor unit Output	External input and output PCB		
			CN47	Output 1	Output 2	Output 3
0-1	60-00	1	Operation/Stop	Operation/Stop	Error status	Indoor unit fan operation status
0-2	60-00	2	Operation/Stop	Error status	Indoor unit fan operation status	External heater output
1	60-01	3	Cooling thermostat On	Error status	Indoor unit fan operation status	External heater output
2	60-02	4	Cooling thermostat On	Error status	Remote controller output	External heater output
3	60-03	5	Cooling thermostat On	Cooling high/low output	Remote controller output	External heater output
4	60-04	6	Cooling thermostat On	Error status	Remote controller output	Cooling high/low output
5	60-05	7	Heating thermostat On	Error status	Indoor unit fan operation status	External heater output
6	60-06	8	Operation/Stop	Error status	Indoor unit fan operation status	Heating thermostat On
7	60-07	9	Cooling thermostat On	Error status	Heating thermostat On	External heater output
8	60-08	A	Cooling thermostat On	Heating thermostat On	Remote controller output	External heater output
9	60-09	B	Error status	Operation/Stop	Indoor unit fan operation status	External heater output
10	60-10	C	Indoor unit fan operation status	Operation/Stop	Error status	External heater output
11	60-11	D	External heater output	Operation/Stop	Indoor unit fan operation status	Error status
12	60-12	D	Set point attainment status	Operation/Stop	Indoor unit fan operation status	Error status

NOTE: Input of Operation/Stop depends on the setting of function setting 46.

00: Operation/Stop mode 1 (R.C. enabled)

01: (Setting prohibited)

02: Forced stop

03: Operation/Stop mode 2 (R.C. disabled)

Input signal type

- Indoor unit
Input signal type is only "Edge".

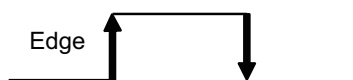

- External input and output PCB
The input signal type can be selected.

Signal type (edge or pulse) can be switched by the DIP switch 2 (SW2) on the External input and output PCB.

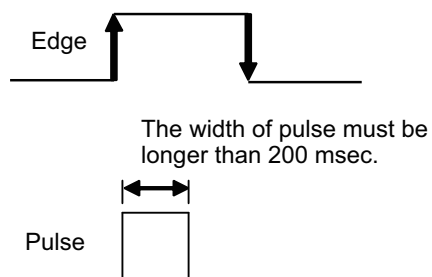

6-4. Details of function

■ Control input function

● When function setting is "Operation/Stop" mode 1

- In the case of "Edge" input

Function setting /	Rotary SW of External input and output PCB	External input		Input signal	Command
46-00	-	Input of indoor unit	Terminal	Off → On	Operation
				On → Off	Stop
	60-00 / 1	External input and output PCB	Input 1	Off → On	Operation
				On → Off	Stop

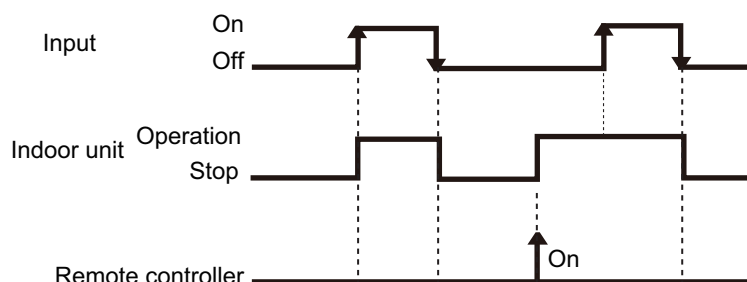

- In the case of "Pulse" input

Function setting /	Rotary SW of External input and output PCB	External input		Input signal	Command
46-00	60-00 / 1	External input and output PCB	Input 1	Pulse	Operation
			Input 2	Pulse	Stop

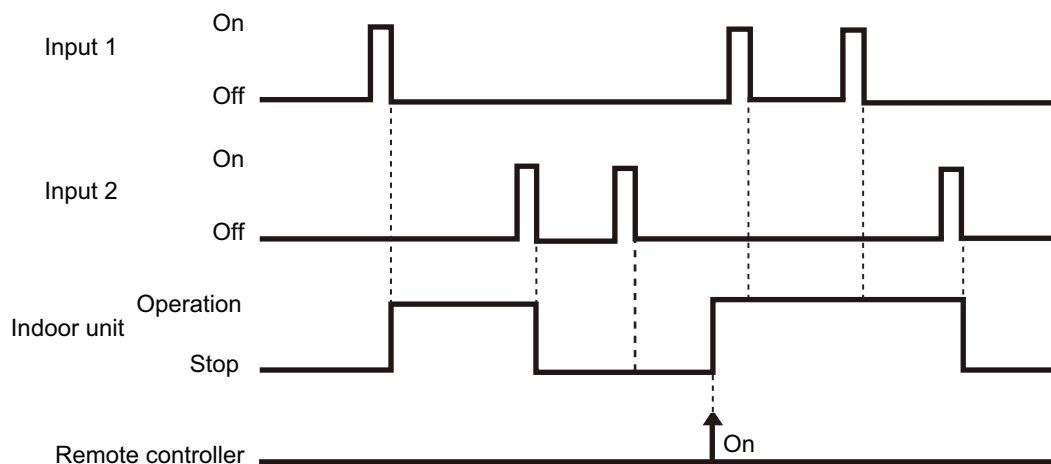

NOTES:

- The last command has priority.
- The indoor units within the same remote controller group operates in the same mode.

● When function setting is "Forced stop" mode

- In the case of "Edge" input

Function setting /	Rotary SW of External input and output PCB	External input		Input signal	Command
46-02	-	Input of indoor unit	Terminal	Off → On	Forced stop
				On → Off	Normal
	60-00 / 1	External input and output PCB	Input 1	Off → On	Forced stop
				On → Off	Normal

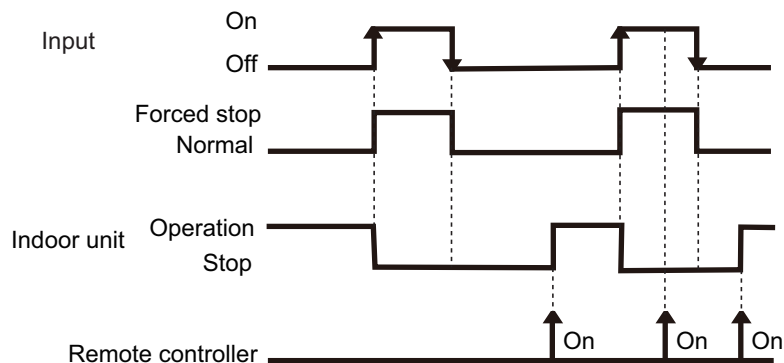

- In the case of "Pulse" input

Function setting /	Rotary SW of External input and output PCB	External input		Input signal	Command
46-02	60-00 / 1	External input and output PCB	Input 1	Pulse	Forced stop
			Input 2	Pulse	Normal

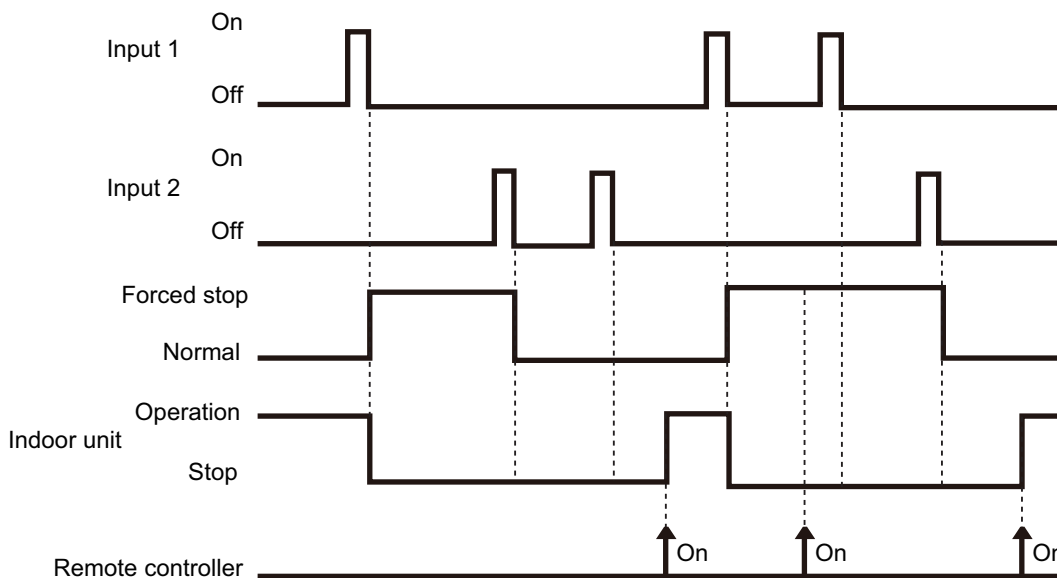

NOTES:

- When the forced stop is triggered, indoor unit stops and Operation/Stop operation by the remote controller is restricted.
- When forced stop function is used with forming a remote controller group, connect the same equipment to each indoor unit within the group.

● When function setting is "Operation/Stop" mode 2

- In the case of "Edge" input

Function setting /	Rotary SW of External input and output PCB	External input		Input signal	Command
46-03	-	Input of indoor unit	Terminal	Off → On	Operation
				On → Off	Stop (R.C. disabled)
	60-00 / 1	External input and output PCB	Input 1	Off → On	Operation
				On → Off	Stop (R.C. disabled)

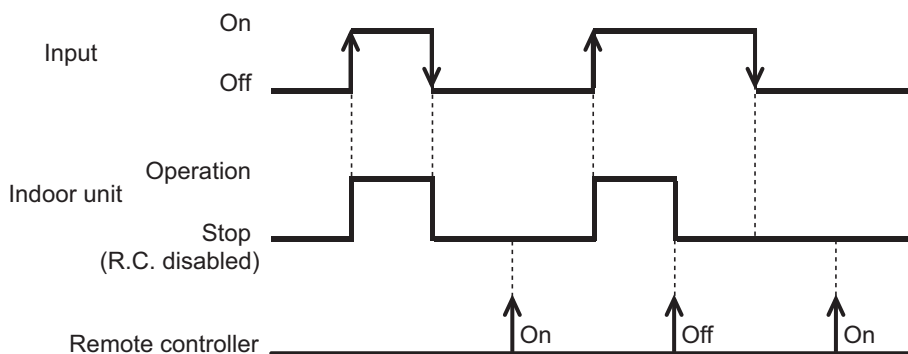

- In the case of "Pulse" input

Function setting /	Rotary SW of External input and output PCB	External input		Input signal	Command
46-03	60-00 / 1	External input and output PCB	Input 1	Pulse	Operation
			Input 2	Pulse	Stop (R.C. disabled)

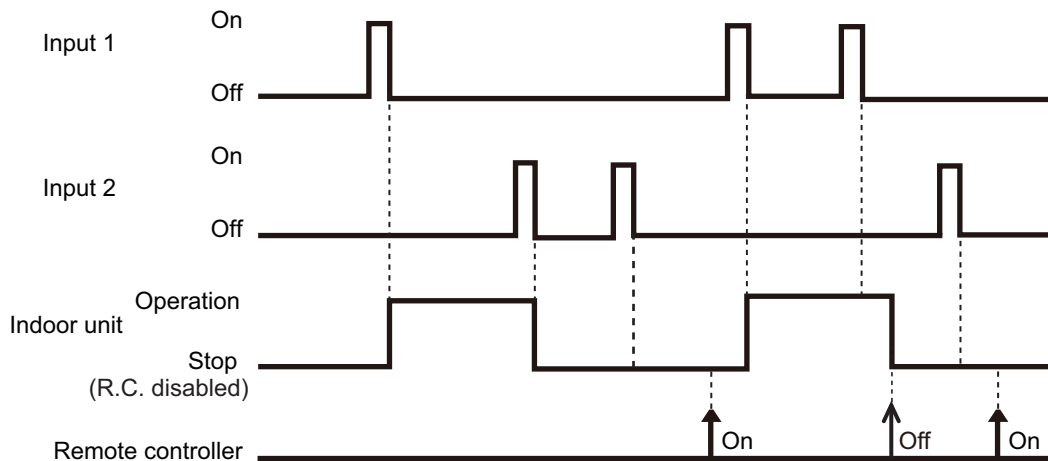

NOTES:

- When "Operation/Stop" mode 2 function is used with forming a remote controller group, connect the same equipment to each indoor unit within the group.

■ Forced thermostat off function

Function setting /	Rotary SW of External input and output PCB	External input		Input signal	Command
60-00 / 2 60-02 / 4 60-05 / 7 60-06 / 8 60-08 / A 60-09 / B 60-10 / C 60-11 / D		External input and output PCB	Input 1	Off → On	Thermostat off
				On → Off	Normal operation

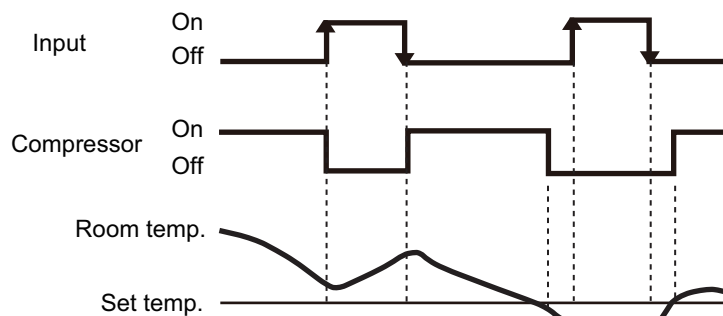

■ Control output function

Function setting /	Rotary SW of External input and output PCB	External output		Output signal	Command
60-00 / 1, 2 60-06 / 8		Output of indoor unit	CN47	Low → High	Operation
				High → Low	Stop
60-00 / 1 60-09 / B 60-10 / C 60-11 / D		External input and output PCB	Output 1	Off → On	Operation
				On → Off	Stop

The output is low when the unit is stopped.

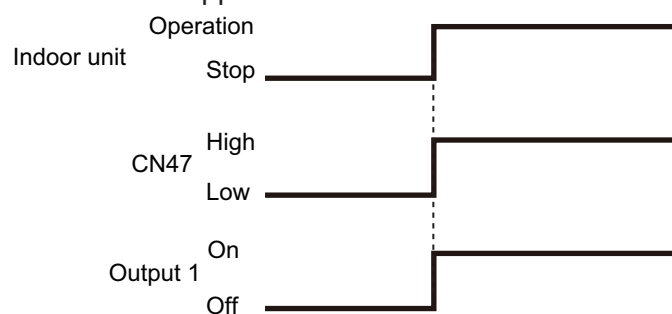

■ Error status

Function setting /	Rotary SW of External input and output PCB	External output		Output signal	Command
60-09 / B		Output of indoor unit	CN47	Low → High	Error
				High → Low	Normal
60-00 / 2 60-01 / 3 60-02 / 4 60-04 / 6 60-05 / 7 60-06 / 8 60-07 / 9		External input and output PCB	Output 1	Off → On	Error
				On → Off	Normal
				Off → On	Error
				On → Off	Normal
				Off → On	Error
				On → Off	Normal
60-00 / 1 60-10 / C			Output 2	Off → On	Error
				On → Off	Normal
60-11 / D			Output 3	Off → On	Error
				On → Off	Normal

The output is ON when an error is generated for the indoor unit.

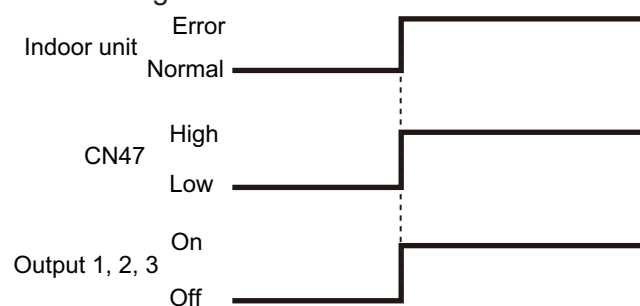

Indoor unit fan operation status

Function setting / Rotary SW of External input and output PCB	External output		Output signal	Command
60-10 / C	Output of indoor unit	CN47	Low → High	Fan run
			High → Low	Fan stop
60-00 / 2 60-01 / 3 60-05 / 7 60-06 / 8 60-09 / B 60-11 / D	External input and output PCB	Output 2	Off → On	Fan run
			On → Off	Fan stop
			Off → On	Fan run
			On → Off	Fan stop
60-00 / 1		Output 3	Off → On	Fan run
			On → Off	Fan stop

Output signal	Condition
On Low → High	The indoor unit fan is operating.
Off High → Low	The fan is stopped or during cold air prevention. During thermostat off when in dry mode operation.

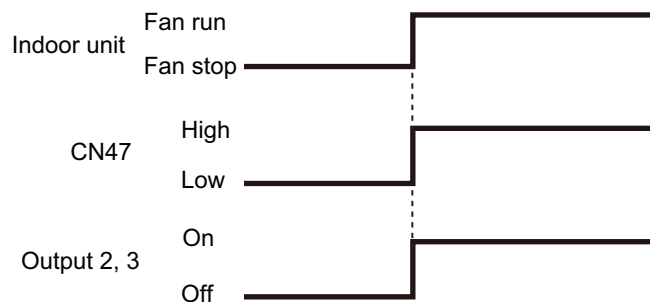

External heater output

Control	Primary heater	Auxiliary heater	Function setting	
			Indoor unit	Wired R. C.
			Control switching external heaters No. 61	Sensor activation*2
Auxiliary heater control 1	Heat pump	External device*1	61-00	—
Auxiliary heater control 2	Heat pump	External device	61-01	—
Heat pump prohibition control	External device	None	61-02	On (Enabled)
Auxiliary heater control by outdoor temperature 1	Heat pump	External device	61-03	On (Enabled)
Auxiliary heater control by outdoor temperature 2	Heat Pump	External device	61-04	On (Enabled)
Auxiliary heater control by outdoor temperature 3	Heat Pump	External device	61-05	On (Enabled)
Auxiliary heat pump control	External device	Heat pump	61-06	On (Enabled)
Auxiliary heat pump control by outdoor temperature 1	External device	Heat pump	61-07	On (Enabled)
Auxiliary heat pump control by outdoor temperature 2	External device	Heat pump	61-08	On (Enabled)
Auxiliary heat pump control by outdoor temperature 3	External device	Heat pump	61-09	On (Enabled)

NOTES:

- After turning off the heater, 3 minutes of standby time is required by next power-on of the heater.
- For items marked “—” in the table, any of validate or invalidate of the setting are acceptable.
- *1: External device means Hot water, Electrical heater, etc.
- *2: Sensor activation:
 - Setting change from the factory setting is required.
 - Indoor unit fan setting will be on for safety reason without sensor activation of wired remote controller.

● Installation configuration of individual connection

External heating device is installed individually. (No use of indoor unit fan)

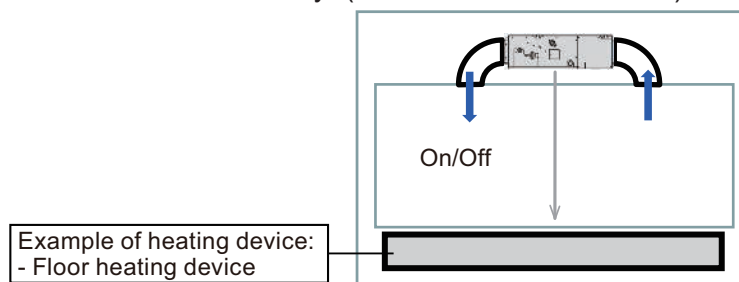

⚠ WARNING

- When auxiliary heater is installed, always set “indoor unit fan setting for external heater”.
- Design and install external heater appropriately with considering its protection.

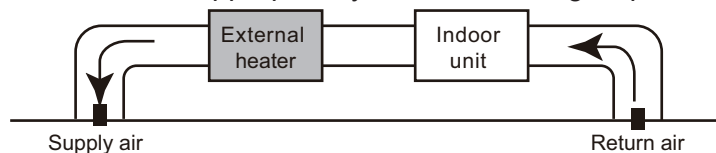

- Inappropriate designing and installation of external heater may cause a fire by emitted heat from the external heater.
- Fujitsu General Ltd. is not responsible for inappropriate designing or installation of external heating device.

● Auxiliary equipment control by room temperature

Auxiliary equipment control is switchable by room temperature. Auxiliary equipment switching is performed for each room temperature divided to following 3 zones.

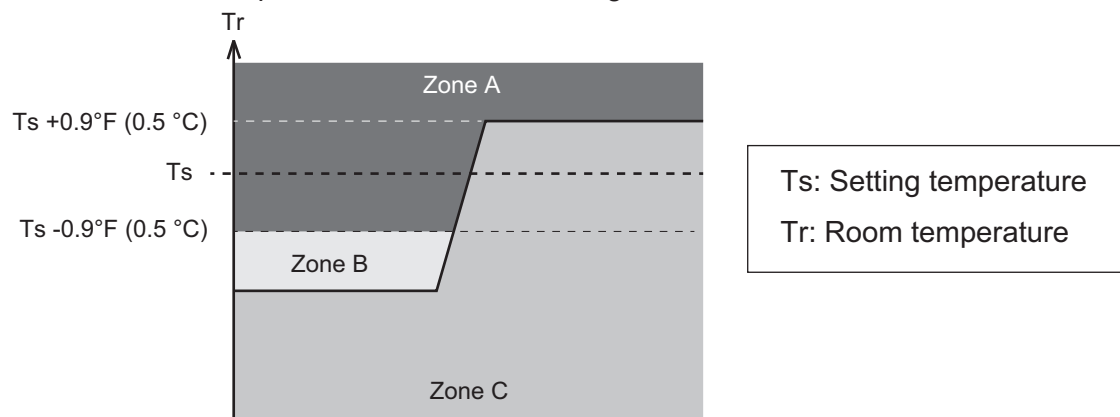

Zone	Application	When temperature dropping		When temperature rising	
		Primary	Auxiliary	Primary	Auxiliary
A	Both of primary and auxiliary equipment is unnecessary.	Off	Off	Off	Off
B	Primary heater only. When room temperature stays in zone B for a long time, auxiliary equipment also operates.	On	Off*1	—	—
C	Auxiliary equipment also operates.	On	On*2	On	On*2

*1: For standby time for auxiliary equipment operation, refer to indoor unit function number 71 "[Contents of function setting](#)" on page 53.

*2: When indoor unit function number 61 is set to "00", auxiliary equipment operates according to the following conditions.

- $T_s - T_r > 21.6 \text{ }^\circ\text{F}$ ($-12.0 \text{ }^\circ\text{C}$): Auxiliary equipment turn off.
- $T_s - T_r > 18.0 \text{ }^\circ\text{F}$ ($-10.0 \text{ }^\circ\text{C}$): Auxiliary equipment turn on.

● Auxiliary heater control 1

Operation	Condition
Heater on	Heater is on as shown in following diagram of heating temperature.
Heater off	<ul style="list-style-type: none"> • Heater is off as shown in following diagram of heating temperature. • Other than heating mode • Error occurred • Forced thermostat off • Fan stop protection

- Temperature of heater on (Thon): Adjustable by function number 62 (Operating temperature switching of external heaters).
- All control temperatures will shift by adjusting “Thon”.

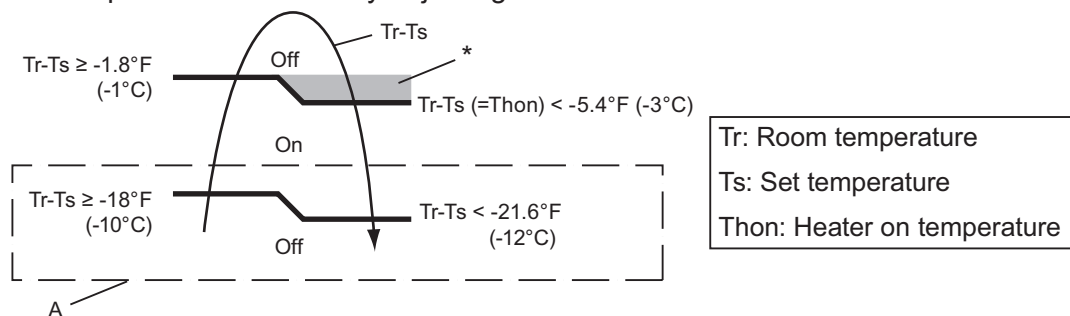

*: When room temperature stays in this zone for a specific time, auxiliary heater is turned on. For details, refer to function number 71.

Example: When set temperature (Ts) is 72°F (22°C) (Factory setting),

- and room temperature (Tr) increases above 53.6°F (12°C), signal output is on.
- and room temperature (Tr) increases above 69.8°F (21°C), signal output is off.
- and room temperature (Tr) decreases below 66.2°F (19°C), signal output is on.
- and room temperature (Tr) decreases below 50°F (10°C), signal output is off.

● Auxiliary heater control 2

Control that excludes “A” from "Auxiliary heater control 1" on page 36.

Operation	Condition
Heater on	Heater is on as shown in following diagram of heating temperature.
Heater off	<ul style="list-style-type: none"> • Heater is off as shown in following diagram of heating temperature. • Other than heating mode • Error occurred • Forced thermostat off • Fan stop protection

- Temperature of heater on (Thon): Adjustable by function number 62 (Operating temperature switching of external heaters).
- All control temperatures will shift by adjusting “Thon”.

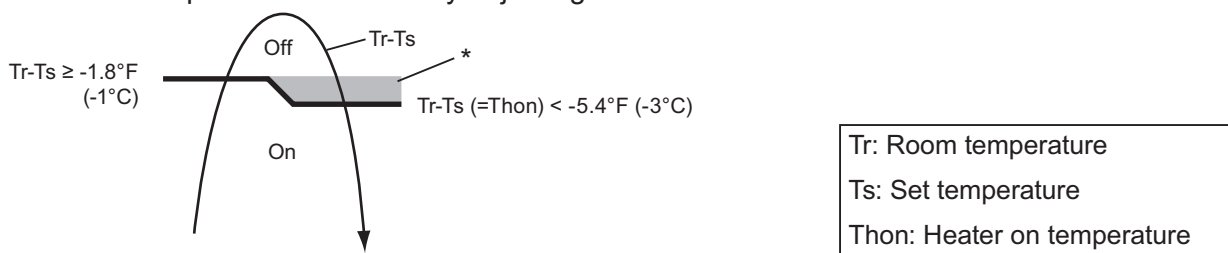

*: When room temperature stays in this zone for a specific time, auxiliary heater is turned off. For details, refer to function number 71.

● Heat pump prohibition control

Perform heating by external heater only. Indoor unit is continuous thermostat off.

Operation			Condition
Heater on			Heater is on as shown in following diagram of heating temperature.
Heater off	DIP-SW101-3 On Indoor unit fan setting for external heater Enabled	On	<ul style="list-style-type: none"> • Heater is off as shown in following diagram of heating temperature. • Other than heating mode • Error occurred • Forced thermostat off • Fan stop protection
	DIP-SW101-3 Off Indoor unit fan setting for external heater Disabled	Off	<ul style="list-style-type: none"> • Heater is off as shown in following diagram of heating temperature. • Other than heating mode • Error occurred • Forced thermostat off

- Temperature of heater on (Thon): Adjustable by function number 62 (Operating temperature switching of external heaters).
- All control temperatures will shift by adjusting “Thon”.

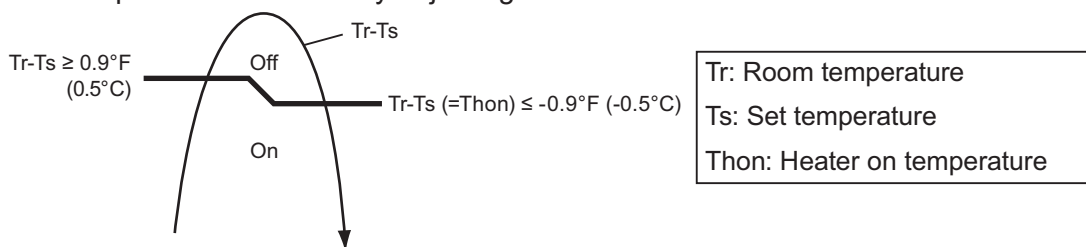

• Operation status

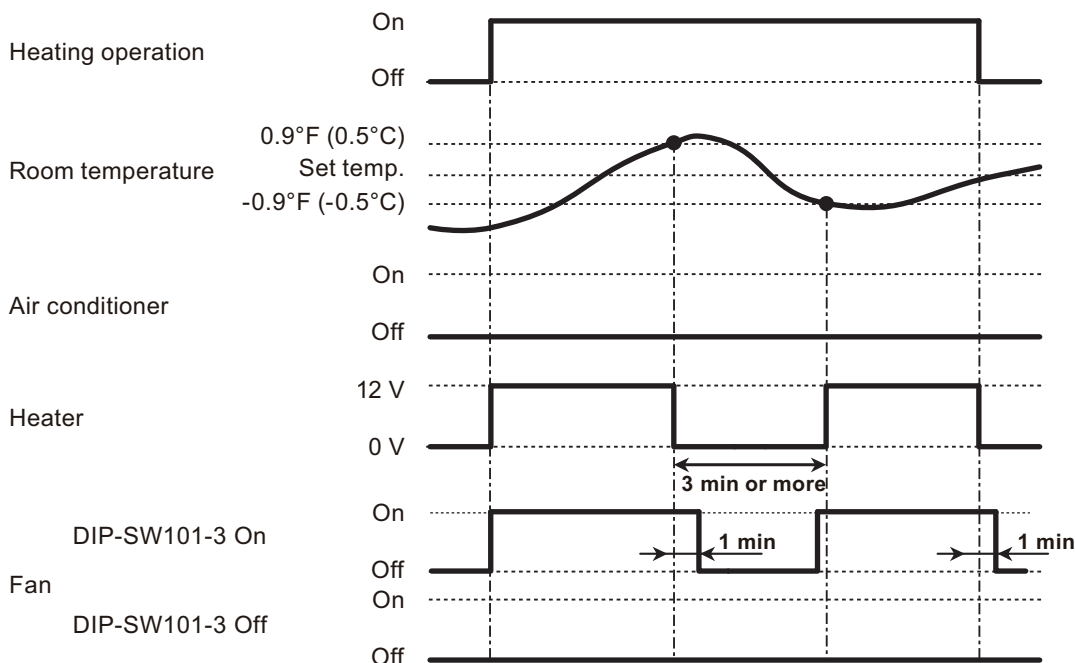

NOTE: In following operations, compressor will be on.

- Other than heating
- Test run

● Auxiliary heater control by outdoor temperature 1

This control selects heat pump or external heater according to the outdoor temperature. When outdoor temperature is high, the heating is performed by using heat pump only.

Operation		Condition
Heater on		Heater is on as shown in following diagram of heating temperature.
Heater off	DIP-SW101-3 On Indoor unit fan setting for external heater Enabled	<ul style="list-style-type: none"> Heater is off as shown in following diagram of heating temperature. Other than heating mode Error occurred Forced thermostat off Heat pump only zone Fan stop protection
	DIP-SW101-3 Off Indoor unit fan setting for external heater Disabled	<ul style="list-style-type: none"> Heater is off as shown in following diagram of heating temperature. Other than heating mode Error occurred Forced thermostat off Heat pump only zone

- Temperature of heater on (Thon): Adjustable by function number 62 (Operating temperature switching of external heaters).
- All control temperatures will shift by adjusting "Thon".
- Outdoor temperature zone boundary A and B: Adjustable individually by function setting number 66 and 67.

• External heater output

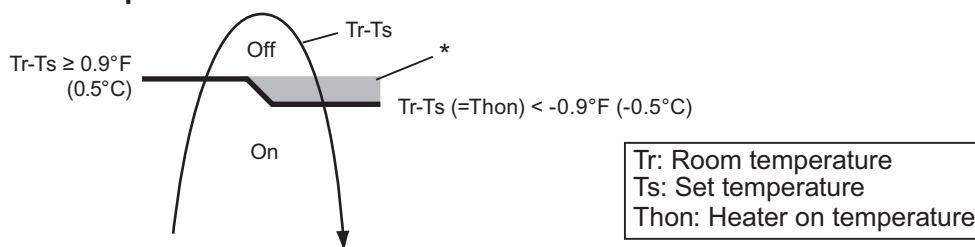

*: When room temperature stays in this zone for a specific time, auxiliary heater is turned on. For details, refer to function number 71.

• Outdoor temperature zone

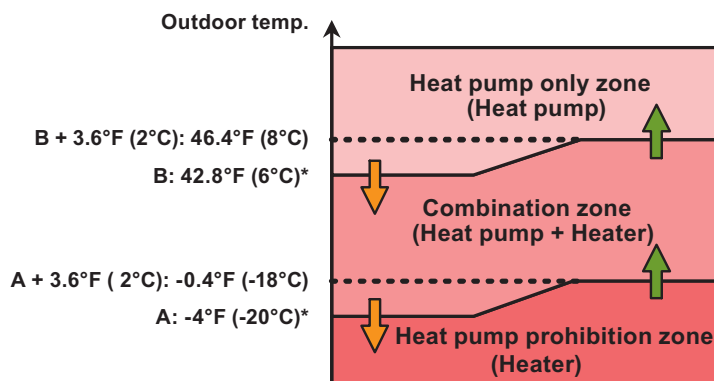

*: Adjustable by function setting 66 and 67

• Operation status

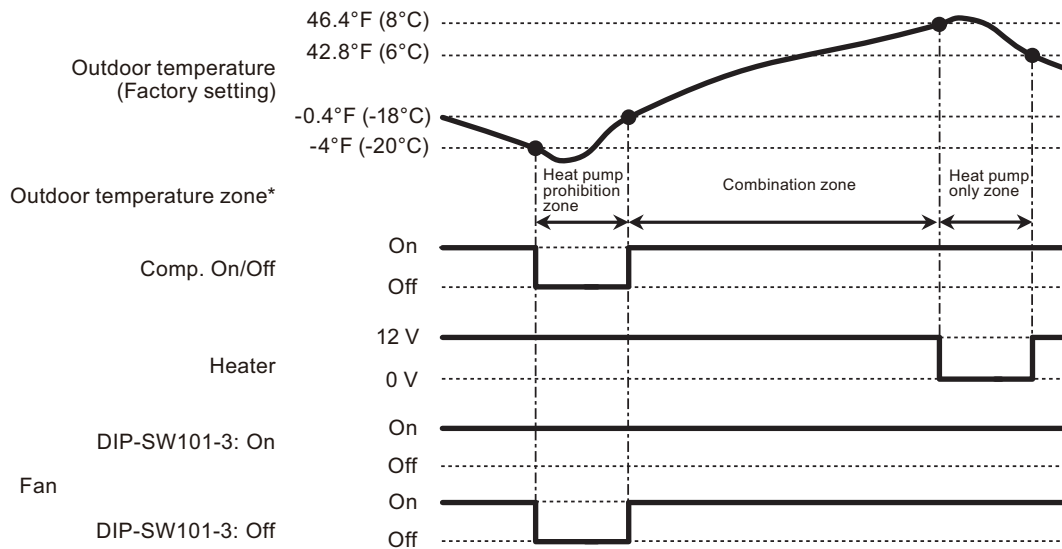

*: The outdoor temperature zone transition from one to another will stay in that zone for minimum of 30 min.

NOTE: In following operations, compressor will be on in heat pump prohibition zone.

- Other than heating
- Test run

● Auxiliary heater control by outdoor temperature 2

This control selects heat pump or external heater according to the outdoor temperature. Even when outdoor temperature is high, the heating is performed by using both of heat pump and external heater.

Operation			Condition
Heater on			Heater is on as shown in following diagram of heating temperature.
Heater off	DIP-SW101-3 Indoor unit fan setting for external heater	On Enabled	<ul style="list-style-type: none"> • Heater is off as shown in following diagram of heating temperature. • Other than heating mode • Error occurred • Forced thermostat off • Fan stop protection
	DIP-SW101-3 Indoor unit fan setting for external heater	Off Disabled	<ul style="list-style-type: none"> • Heater is off as shown in following diagram of heating temperature. • Other than heating mode • Error occurred • Forced thermostat off

- Temperature of heater on (Thon): Adjustable by function number 62 (Operating temperature switching of external heaters).
- All control temperatures will shift by adjusting “Thon”.
- Outdoor temperature zone boundary A: Adjustable by function setting number 66.

• External heater output

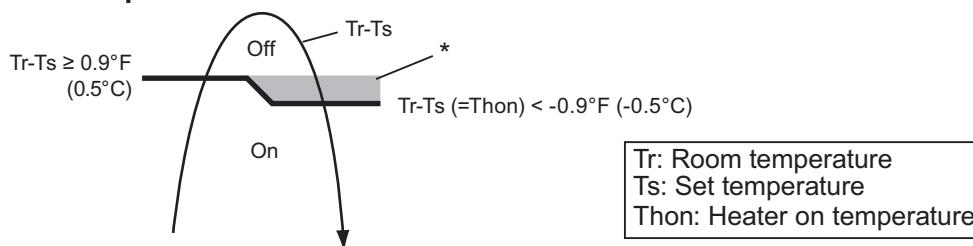

*: When room temperature stays in this zone for a specific time, auxiliary heater is turned on. For details, refer to function number 71.

• Outdoor temperature zone

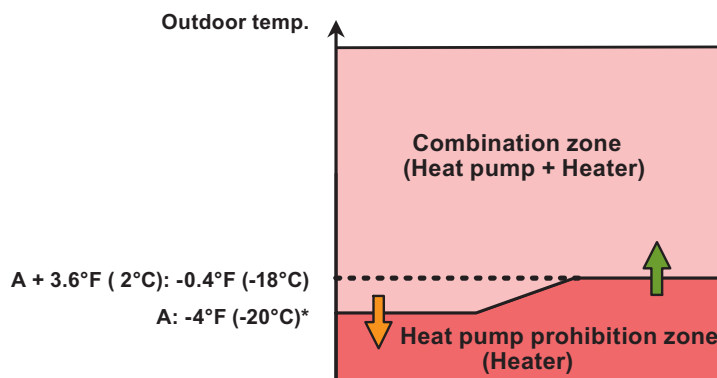

*: Adjustable by function setting 66

• Operation status

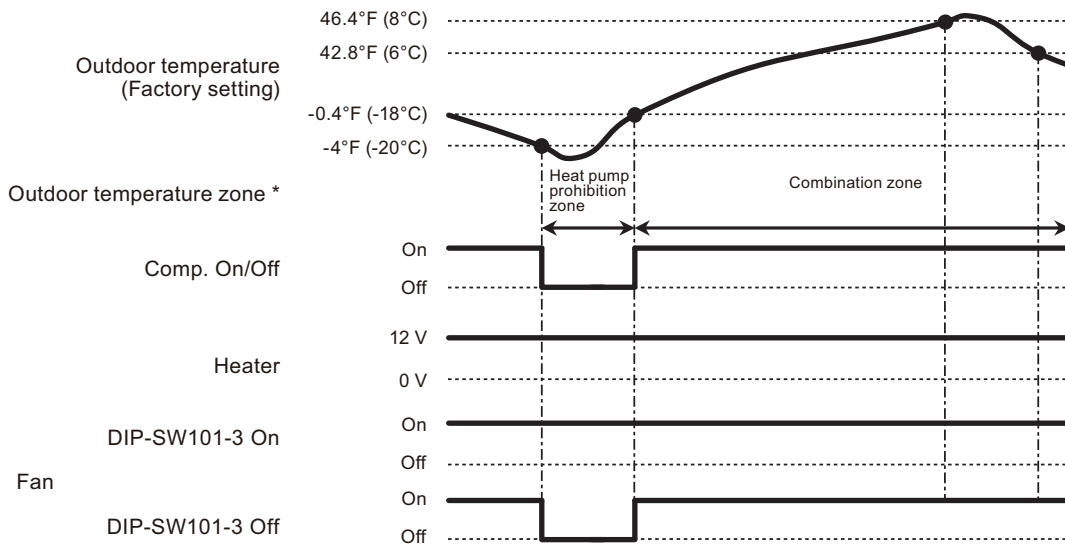

* The outdoor temperature zone transition from one to another will stay in that zone for minimum of 30 min.

NOTE: In following operations, compressor will be on in heat pump prohibition zone.

- Other than heating
- Test run

● Auxiliary heater control by outdoor temperature 3

This control selects heat pump or external heater according to the outdoor temperature. Even when outdoor temperature is high, the heating is performed by using both of heat pump and external heater.

Operation		Condition	
Heater on		Heater is on as shown in following diagram of heating temperature.	
Heater off	DIP-SW101-3 Indoor unit fan setting for external heater	On Enabled	<ul style="list-style-type: none"> Heater is off as shown in following diagram of heating temperature. Other than heating mode Error occurred Forced thermostat off Fan stop protection
	DIP-SW101-3 Indoor unit fan setting for external heater	Off Disabled	<ul style="list-style-type: none"> Heater is off as shown in following diagram of heating temperature. Other than heating mode Error occurred Forced thermostat off

- Temperature of heater on (Thon): Adjustable by function number 62 (Operating temperature switching of external heaters).
- All control temperatures will shift by adjusting "Thon".
- Outdoor temperature zone boundary B: Adjustable by function setting number 67.

• External heater output

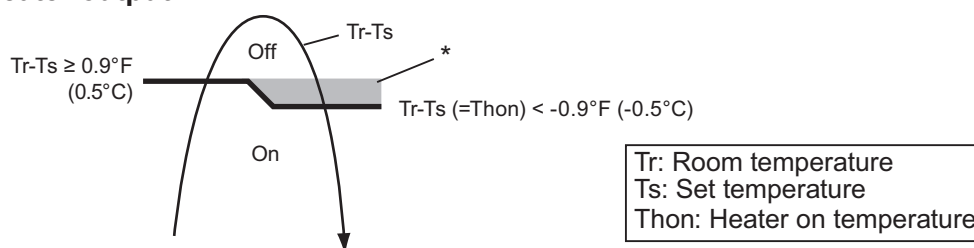

*: When room temperature stays in this zone for a specific time, auxiliary heater is turned on. For details, refer to function number 71.

• Outdoor temperature zone

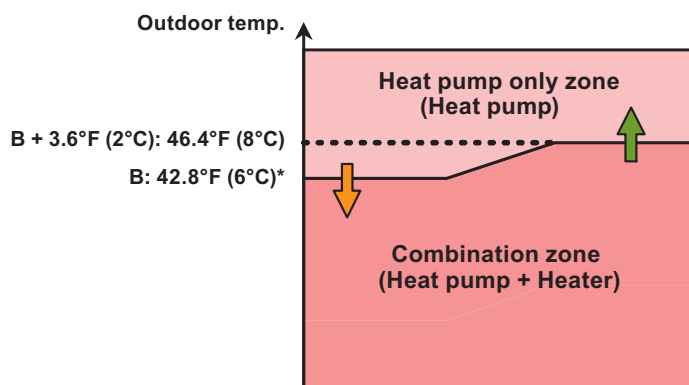

*: Adjustable by function setting 67

• Operation status

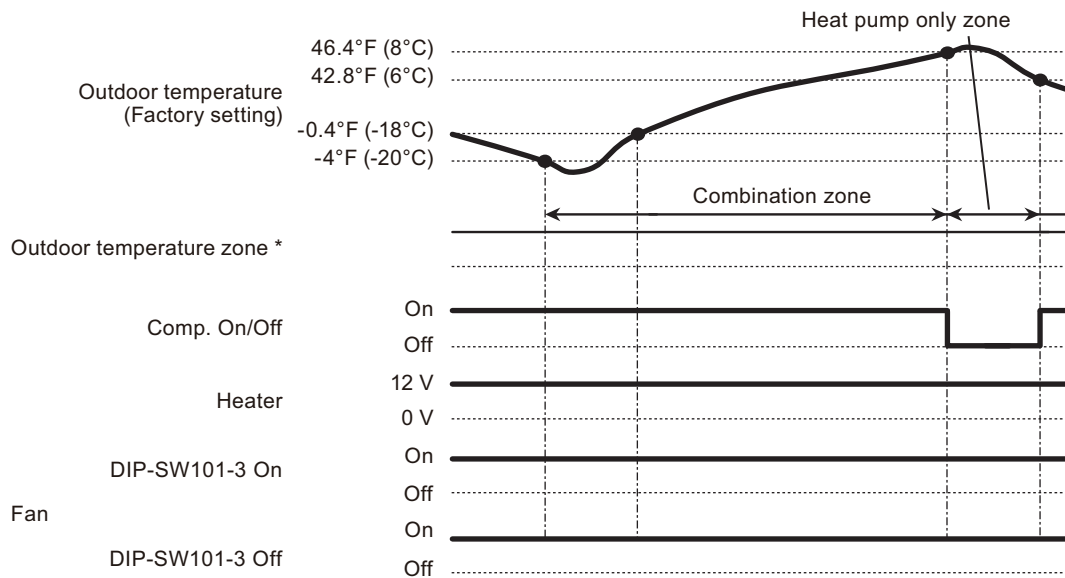

*: The outdoor temperature zone transition from one to another will stay in that zone for minimum of 30 min.

NOTE: In following operations, compressor will be on in heat pump prohibition zone.

- Other than heating
- Test run

● Auxiliary heat pump control

• External heater output

Operation			Condition
Heater on			Heater is on as shown in following diagram of heating temperature.
Heater off	DIP-SW101-3 Indoor unit fan setting for external heater	On Enabled	<ul style="list-style-type: none"> • Heater is off as shown in following diagram of heating temperature. • Other than heating mode • Error occurred • Forced thermostat off • Fan stop protection
	DIP-SW101-3 Indoor unit fan setting for external heater	Off Disabled	<ul style="list-style-type: none"> • Heater is off as shown in following diagram of heating temperature. • Other than heating mode • Error occurred • Forced thermostat off

- Temperature of heater on (Thon): Set temperature (Ts) - 0.9 °F (- 0.5 °C)
- Temperature of heater off: Set temperature (Ts) + 0.9 °F (+ 0.5 °C)

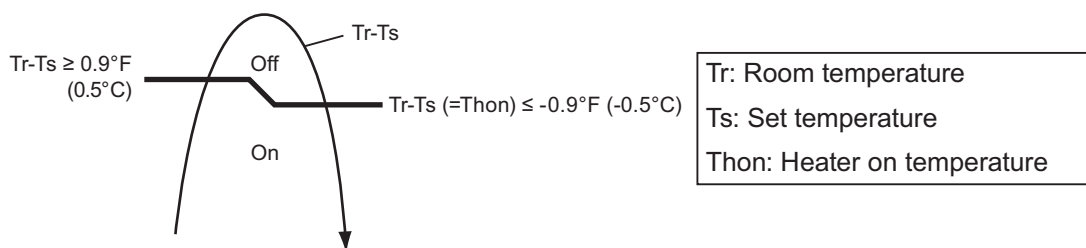

• Auxiliary heat pump On/Off

- Temperature of heater on (Thon): Adjustable by function number 62 (Operating temperature switching of heat pump).
- All control temperatures will shift by adjusting “Thon”.

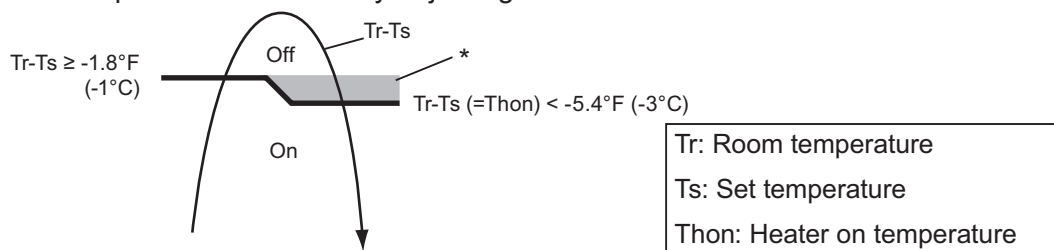

*: When room temperature stays in this zone for a specific time, auxiliary heater is turned on. For details, refer to function number 71.

● Auxiliary heat pump control by outdoor temperature 1

• External heater output

Operation		Condition
Heater on		Heater is on as shown in following diagram of heating temperature.
Heater off	DIP-SW101-3 On Indoor unit fan setting for external heater Enabled	<ul style="list-style-type: none"> • Heater is off as shown in following diagram of heating temperature. • Other than heating mode • Error occurred • Forced thermostat off • Fan stop protection
	DIP-SW101-3 Off Indoor unit fan setting for external heater Disabled	<ul style="list-style-type: none"> • Heater is off as shown in following diagram of heating temperature. • Other than heating mode • Error occurred • Forced thermostat off

- Temperature of heater on (Thon): Set temperature (Ts) - 0.9 °F (- 0.5 °C)
- Temperature of heater off: Set temperature (Ts) + 0.9 °F (+ 0.5 °C)

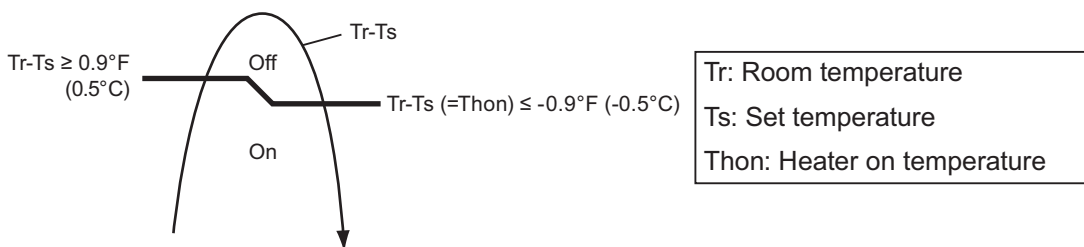

• Auxiliary heat pump On/Off

- Temperature of heater on (Thon): Adjustable by function number 62 (Operating temperature switching of heat pump).
- All control temperatures will shift by adjusting “Thon”.

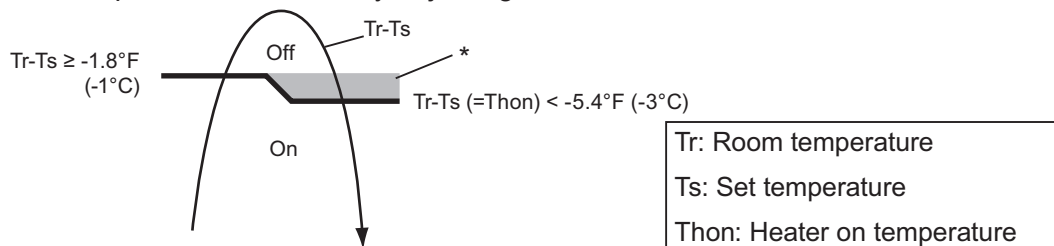

*: When room temperature stays in this zone for a specific time, auxiliary heater is turned on. For details, refer to function number 71.

• Outdoor temperature zone

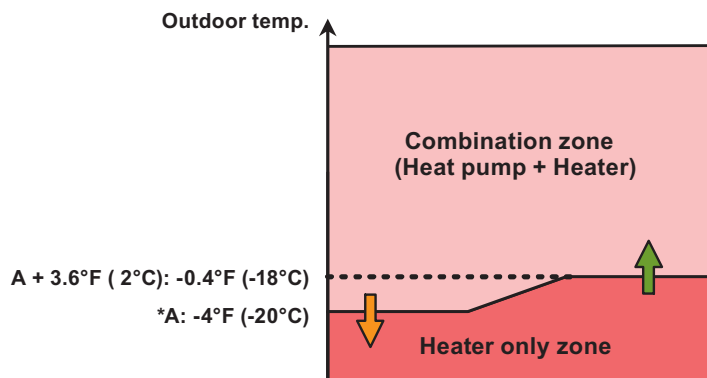

*: Adjustable by function setting 67

• Operation status

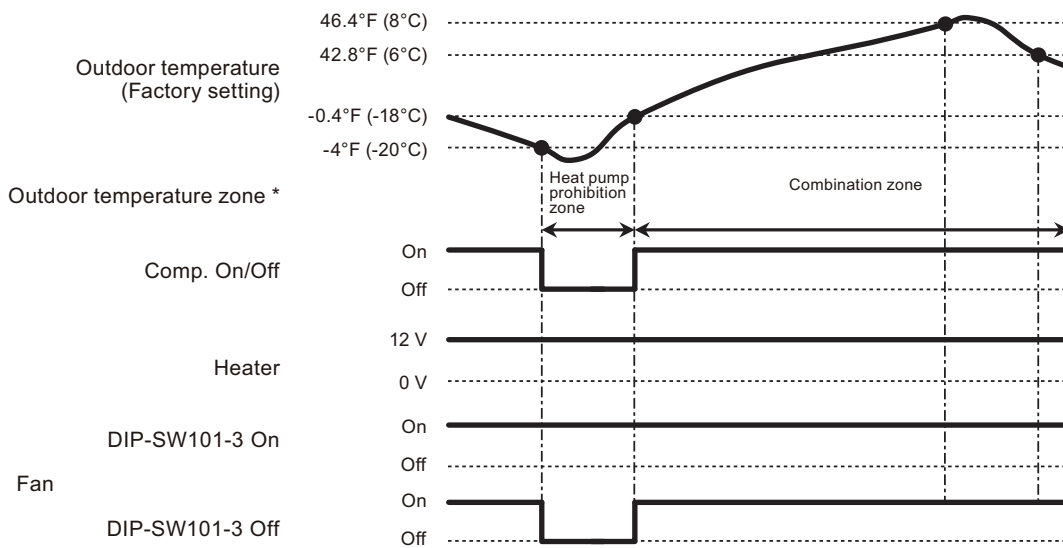

* The outdoor temperature zone transition from one to another will stay in that zone for minimum of 30 min.

NOTE: In following operations, compressor will be on in heat pump prohibition zone.

- Other than heating
- Test run

● Auxiliary heat pump control by outdoor temperature 2

• External heater output

Operation			Condition
Heater on			Heater is on as shown in following diagram of heating temperature.
Heater off	DIP-SW101-3 Indoor unit fan setting for external heater	On Enabled	<ul style="list-style-type: none"> • Heater is off as shown in following diagram of heating temperature. • Other than heating mode • Error occurred • Forced thermostat off • Fan stop protection
	DIP-SW101-3 Indoor unit fan setting for external heater	Off Disabled	<ul style="list-style-type: none"> • Heater is off as shown in following diagram of heating temperature. • Other than heating mode • Error occurred • Forced thermostat off

- Temperature of heater on (Thon): Set temperature (Ts) - 0.9 °F (- 0.5 °C)
- Temperature of heater off: Set temperature (Ts) + 0.9 °F (+ 0.5 °C)

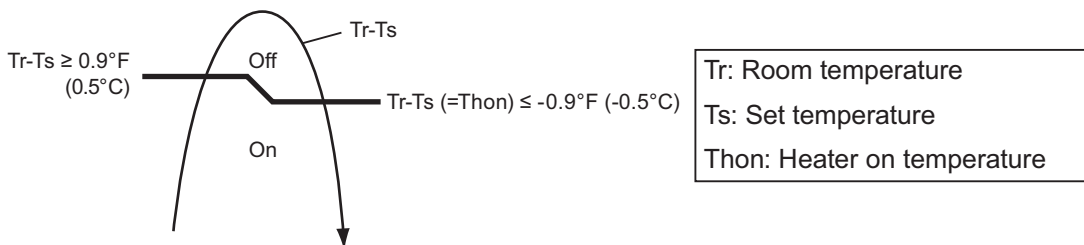

• Auxiliary heat pump On/Off

- Temperature of heater on (Thon): Adjustable by function number 62 (Operating temperature switching of heat pump).
- All control temperatures will shift by adjusting “Thon”.

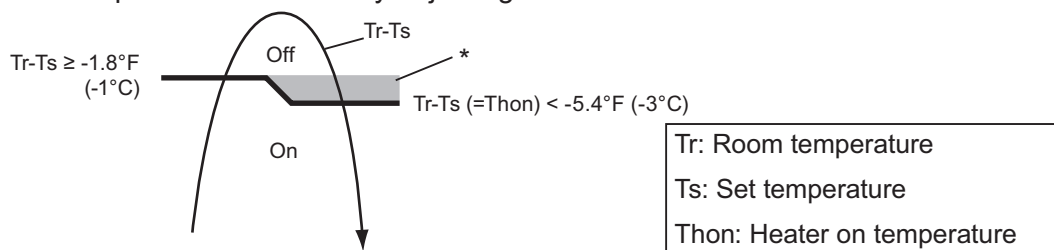

*: When room temperature stays in this zone for a specific time, auxiliary heater is turned on. For details, refer to function number 71.

• Outdoor temperature zone

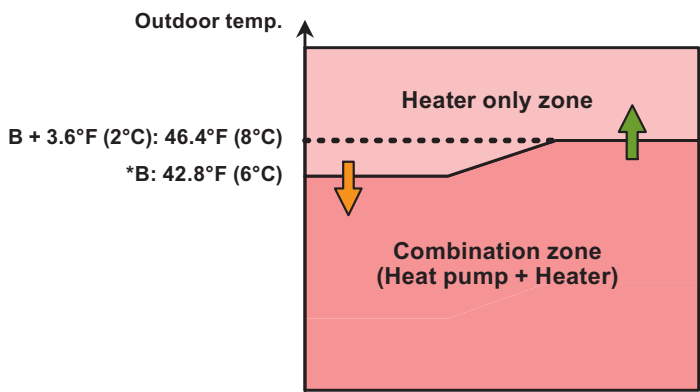

*: Adjustable by function setting 67

• Operation status

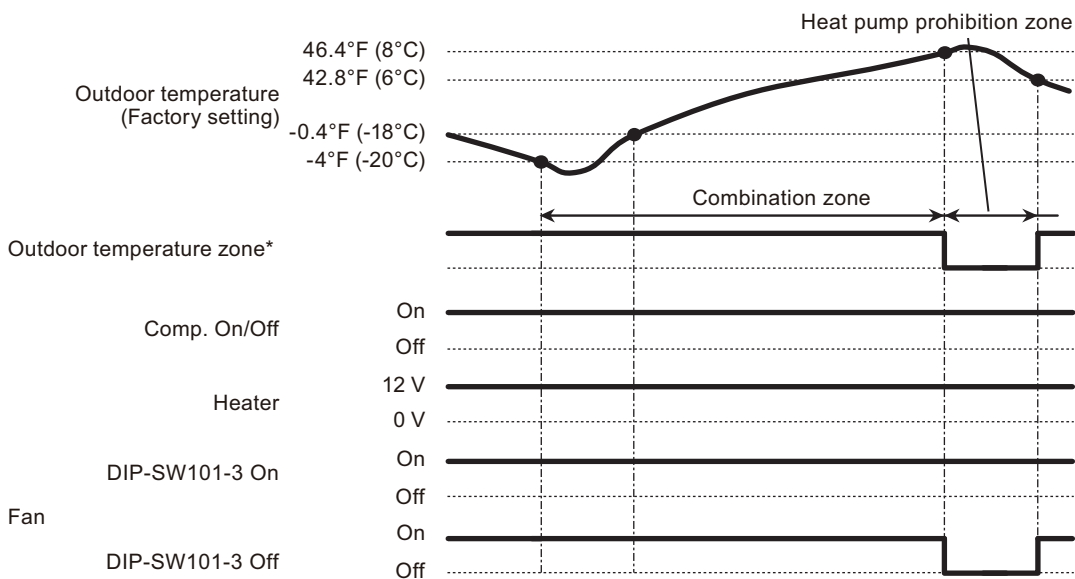

*: The outdoor temperature zone transition from one to another will stay in that zone for minimum of 30 min.

NOTE: In following operations, compressor will be on in heat pump prohibition zone.

- Other than heating
- Test run

● Auxiliary heat pump control by outdoor temperature 3

• External heater output

Operation			Condition
Heater on			Heater is on as shown in following diagram of heating temperature.
Heater off	DIP-SW101-3 Indoor unit fan setting for external heater	On Enabled	<ul style="list-style-type: none"> • Heater is off as shown in following diagram of heating temperature. • Other than heating mode • Error occurred • Forced thermostat off • Fan stop protection
	DIP-SW101-3 Indoor unit fan setting for external heater	Off Disabled	<ul style="list-style-type: none"> • Heater is off as shown in following diagram of heating temperature. • Other than heating mode • Error occurred • Forced thermostat off

- Temperature of heater on (Thon): Set temperature (Ts) - 0.9 °F (- 0.5 °C)
- Temperature of heater off: Set temperature (Ts) + 0.9 °F (+ 0.5 °C)

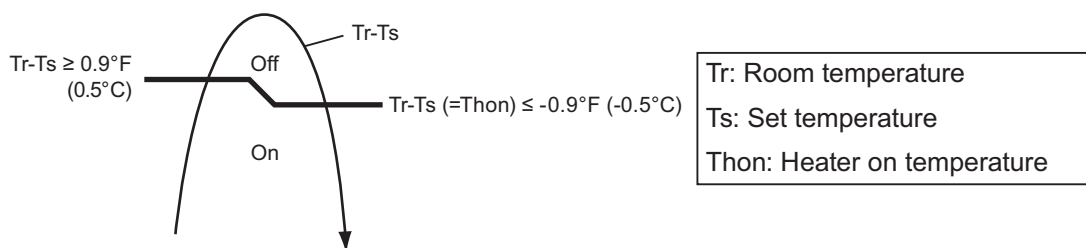

• Auxiliary heat pump On/Off

- Temperature of heater on (Thon): Adjustable by function number 62 (Operating temperature switching of heat pump).
- All control temperatures will shift by adjusting “Thon”.

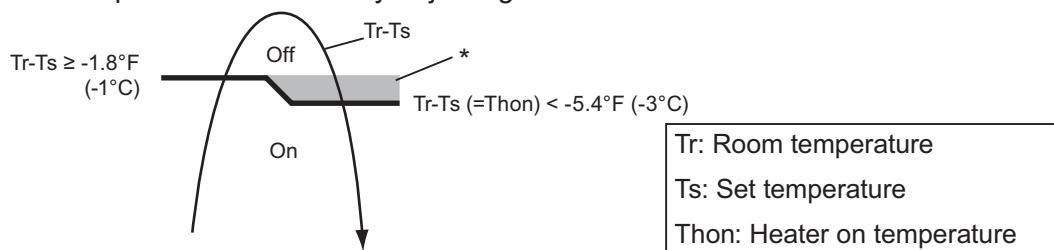

*: When room temperature stays in this zone for a specific time, auxiliary heater is turned on. For details, refer to function number 71.

• Outdoor temperature zone

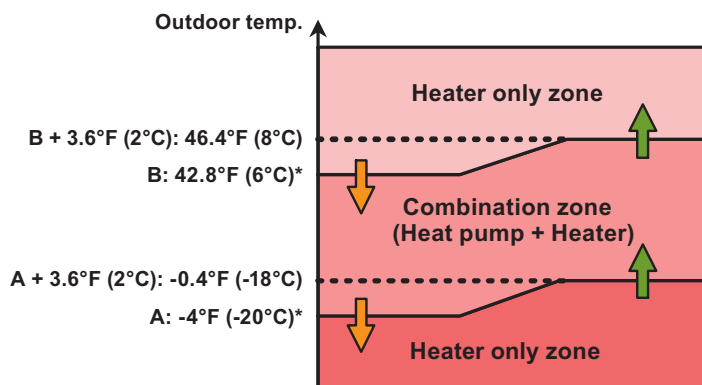

*: Adjustable by function setting 66 and 67

• Operation status

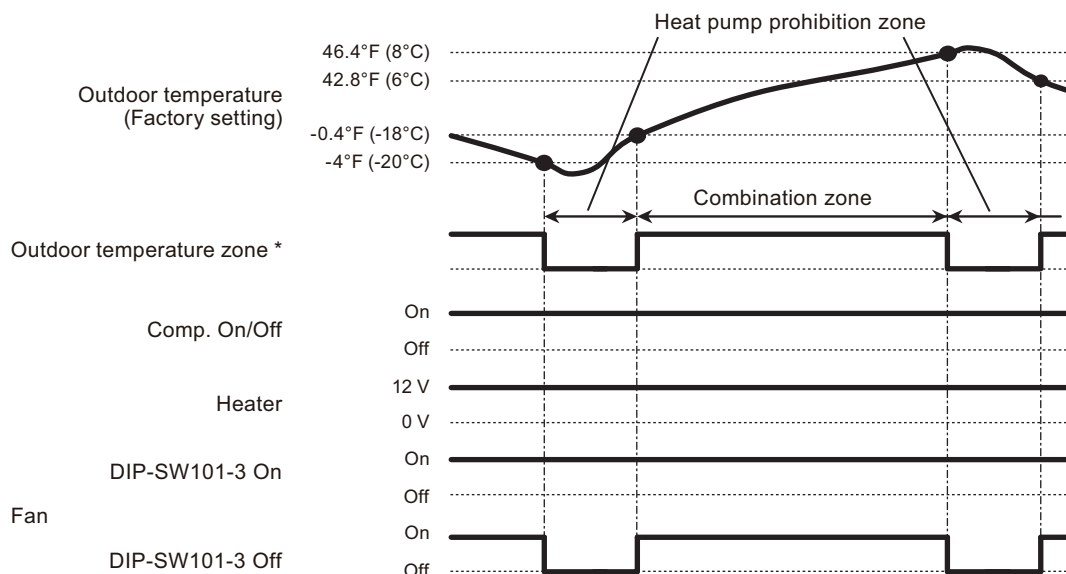

* The outdoor temperature zone transition from one to another will stay in that zone for minimum of 30 min.

NOTE: In following operations, compressor will be on in heat pump prohibition zone.

- Other than heating
- Test run

■ Heating thermostat on for humidifier

Situation	Indoor unit				
	Mode	Function setting	Rotary SW	External output	
		Heating thermostat on no. 60		Heating thermostat on	Indoor unit fan operation status
Example of individual connection	5	60-05	7	CN47	Not used
	6	60-06	8	Output3	
	7	60-07	9	Output2	
	8	60-08	A	Output1	

- Example of individual connection

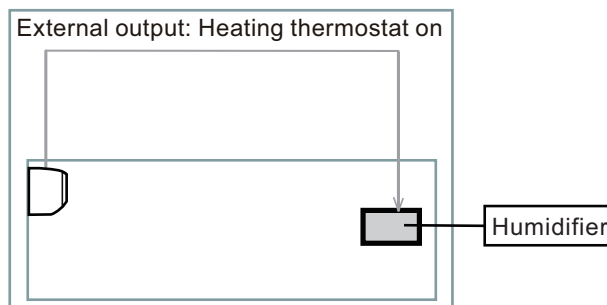

- Operation status

The heating thermostat output for CN47, Output1, Output2, and Output3 will be on when comp on or external heater on.

The heating thermostat output will be off when comp off and external heater off.

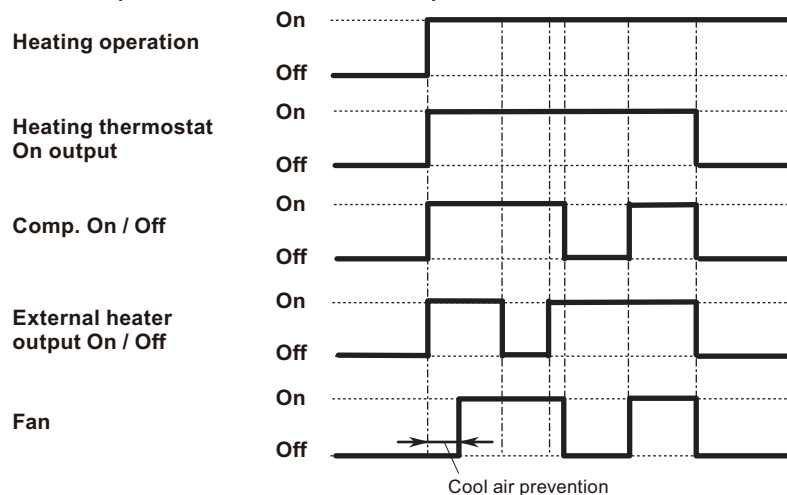

7. Function settings

To adjust the functions of this product according to the installation environment, various types of function settings are available.

NOTE: Incorrect settings can cause a product malfunction.

7-1. Function settings on indoor unit

■ Models: AMUG24LMAS, AMUG30LMAS, AMUG36LMAS, and AMUG48LMAS

By using some components on the PCB, you can change the function settings.

Related components on the PCB and the applicable settings

Component		Setting content
DIP switch101	1	Setting change prohibited
	2	Setting change prohibited
	3	Fan delay setting

● Component location

Components on the indoor unit main PCB used for the function settings are located as shown in the following figure.

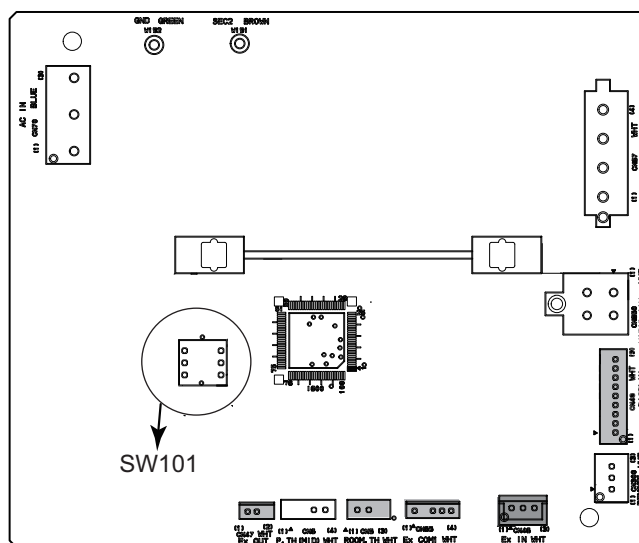

● DIP switch setting

- **Switch 1: Setting change prohibited (SW101)**
- **Switch 2: Setting change prohibited (SW101)**
- **Switch 3: Fan delay setting (SW101)**

When the indoor unit is stopped while operating in conjunction with auxiliary heater, the indoor unit fan operation will continue for 1 minute.

Switch 3	Fan delay	Factory setting
ON	Enabled	
OFF	Disabled	◆

7-2. Function settings by using remote controller

Some function settings can be changed on the remote controller. After confirming the setting procedure and the content of each function setting, select appropriate functions for your installation environment.

■ Setting procedure by using remote controller

Remote controller is not attached for this product. For details of the installing remote controller, refer to following information.

- Overview information: Operating manual of the remote controller
- Setting procedure: Installation manual of the remote controller

■ Contents of function setting

Each function setting listed in this section is adjustable in accordance with the installation environment.

NOTE: Setting will not be changed if invalid numbers or setting values are selected.

● Function setting list

	Function no.	Functions
1)	11	Filter sign
2)	30/31	Room temperature control for indoor unit sensor
3)	35/36	Room temperature control for wired remote controller sensor
4)	40	Auto restart
5)	42	Room temperature sensor switching
6)	43	Cold air prevention
7)	46	External input control
8)	48	Room temperature sensor switching (Aux.)
9)	49	Indoor unit fan control for energy saving for cooling
10)	60	Switching functions for external output terminal
11)	61	Control switching of external heaters
12)	62	Operating temperature switching of external heaters
13)	66	Outdoor temperature zone boundary temperature A
14)	67	Outdoor temperature zone boundary temperature B
15)	71	Standby time for auxiliary equipment operation
16)	72	Heat pump backup setting
17)	73	Emergency heat
18)	74	Fan delay time
19)	75	External heater use in defrosting
20)	92	Airflow adjustment for operation mode
21)	93	Airflow adjustment at heater only operation

1) Filter sign

Select appropriate intervals for displaying the filter sign on the indoor unit according to the estimated amount of dust in the air of the room.

If the indication is not required, select "No indication" (03).

Function number	Setting value	Setting description	Factory setting
11	00	Standard (2,500 hours)	
	01	Long interval (4,400 hours)	
	02	Short interval (1,250 hours)	
	03	No indication	◆

2) Room temperature control for indoor unit sensor

Depending on the installed environment, correction of the room temperature sensor may be required. Select the appropriate control setting according to the installed environment.

The temperature of the room temperature sensor is corrected as follows:

Corrected temp. = Temp. of the room temp. sensor - Correction temp. value

Example of correction:

When the temperature of the room temp. sensor is 78°F and the setting value is "03" (-2°F), the corrected temp. will be 80°F (78°F - [-2°F]).

The temperature correction values show the difference from the Standard setting "00" (manufacturer's recommended value).

Function number		Setting value	Setting description	Factory setting	
30 (For cooling)	31 (For heating)	00	Standard setting	◆	
		01	No correction 0.0 °F (0.0 °C)		
		02	-1 °F (-0.5 °C)	More cooling Less heating	
		03	-2 °F (-1.0 °C)		
		04	-3 °F (-1.5 °C)		
		05	-4 °F (-2.0 °C)		
		06	-5 °F (-2.5 °C)		
		07	-6 °F (-3.0 °C)		
		08	-7 °F (-3.5 °C)		
		09	-8 °F (-4.0 °C)		
		10	+1 °F (+0.5 °C)	Less cooling More heating	
		11	+2 °F (+1.0 °C)		
		12	+3 °F (+1.5 °C)		
		13	+4 °F (+2.0 °C)		
		14	+5 °F (+2.5 °C)		
		15	+6 °F (+3.0 °C)		
		16	+7 °F (+3.5 °C)		
17	+8 °F (+4.0 °C)				

3) Room temperature control for wired remote controller sensor

Depending on the installed environment, correction of the wire remote temperature sensor may be required. Select the appropriate control setting according to the installed environment.

To change this setting, set Function 42 to Both "01".

Ensure that the Thermo Sensor icon is displayed on the remote controller screen.

Function number		Setting value	Setting description	Factory setting	
35 (For cooling)	36 (For heating)	00	Standard setting	◆	
		01	No correction 0.0 °F (0.0 °C)		
		02	-1 °F (-0.5 °C)	More cooling Less heating	
		03	-2 °F (-1.0 °C)		
		04	-3 °F (-1.5 °C)		
		05	-4 °F (-2.0 °C)		
		06	-5 °F (-2.5 °C)		
		07	-6 °F (-3.0 °C)		
		08	-7 °F (-3.5 °C)		
		09	-8 °F (-4.0 °C)		
		10	+1 °F (+0.5 °C)	Less cooling More heating	
		11	+2 °F (+1.0 °C)		
		12	+3 °F (+1.5 °C)		
		13	+4 °F (+2.0 °C)		
		14	+5 °F (+2.5 °C)		
		15	+6 °F (+3.0 °C)		
		16	+7 °F (+3.5 °C)		
17	+8 °F (+4.0 °C)				

4) Auto restart

Enables or disables automatic restart after a power interruption.

Function number	Setting value	Setting description	Factory setting
40	00	Enable	◆
	01	Disable	

NOTE: Auto restart is an emergency function such as for power outage etc. Do not attempt to use this function in normal operation. Be sure to operate the unit by remote controller or external device.

5) Room temperature sensor switching

When using the wired remote controller temperature sensor, change the setting to "Both" (01).

Function number	Setting value	Setting description	Factory setting
42	00	Indoor unit	◆
	01	Both	

00: Sensor on the indoor unit is active.

01: Sensors on both indoor unit and wired remote controller are active.

NOTE: Remote controller sensor must be turned on by using the remote controller.

6) Cold air prevention

This setting is to disable the cold air prevention function during heating operation. When disabled, the fan setting will always follow the setting on the remote controller. (Excluding defrost mode)

Function number	Setting value	Setting description	Factory setting
43	00	Enable	◆
	01	Disable	

7) External input control

"Operation/Stop" mode or "Forced stop" mode can be selected.

Function number	Setting value	Setting description	Factory setting
46	00	Operation/Stop mode 1	◆
	01	(Setting prohibited)	
	02	Forced stop mode	
	03	Operation/Stop mode 2	

8) Room temperature sensor switching (Aux.)

To use the temperature sensor on the wired remote controller only, change the setting to "Wired remote controller" (01).

This function will only work if the function setting 42 is set at "Both" (01).

When the setting value is set to "Both" (00), more suitable control of the room temperature is possible by setting function setting 30 and 31 too.

Function number	Setting value	Setting description	Factory setting
48	00	Both	◆
	01	Wired remote controller	

9) Indoor unit fan control for energy saving for cooling

Enables or disables the power-saving function by controlling the indoor unit fan rotation when the outdoor unit is stopped during cooling operation.

Function number	Setting value	Setting description	Factory setting
49	00	Disable	◆
	01	Enable	
	02	Remote controller	

00: When the outdoor unit is stopped, the indoor unit fan operates continuously following the setting on the remote controller.

01: When the outdoor unit is stopped, the indoor unit fan operates intermittently at a very low speed.

02: Enable or disable this function by remote controller setting.

NOTES:

- As the factory setting, this setting is initially invalidated.
- Set to "00" or "01" when connecting a remote controller that cannot set the Fan control for energy saving function or connecting a network converter.
To confirm if the remote controller has this setting, refer to the operating manual of each remote controller.

10) Switching functions for external output terminal

Functions of the external output terminal can be switched. For details, refer to “External input and output”.

Function number	Setting value	Setting description	Factory setting
60	00	Operation status	◆
	01—04	Cooling thermostat On	
	05	Heating operation	
	06	Operation/Stop	
	07—08	Cooling thermostat On	
	09	Error status	
	10	Indoor unit fan operation status	
	11	External heater	

11) Control switching of external heaters

Sets the control method for external heater to be used.

For details, refer to “External heater output” in Chapter 6-4. ["Details of function"](#) on page 27.

Function number	Setting value	Setting description	Factory setting
61	00	Auxiliary heater control 1	◆
	01	Auxiliary heater control 2	
	02	Heat pump prohibition control	
	03	Auxiliary heater control by outdoor temperature 1	
	04	Auxiliary heater control by outdoor temperature 2	
	05	Auxiliary heater control by outdoor temperature 3	
	06	Auxiliary heat pump control	
	07	Auxiliary heat pump control by outdoor temperature 1	
	08	Auxiliary heat pump control by outdoor temperature 2	
	09	Auxiliary heat pump control by outdoor temperature 3	

12) Operating temperature switching of external heaters

Sets the temperature conditions when the external heater is ON.

For details, refer to "External heater output" in Chapter 6-4. ["Details of function"](#) on page 27.

Function number	Setting value	Setting description				Factory setting
		Setting value of function 61:				
		00		01 to 09		
		Heater: On	Heater: Off	Heater: On	Heater: Off	
62	00	-5.4 °F (-3 °C)	-1.8 °F (-1 °C)	-0.9 °F (-0.5 °C)	0.9 °F (0.5 °C)	◆
	01	-3.6 °F (-2 °C)	-1.8 °F (-1 °C)	-1.8 °F (-1 °C)	0.9 °F (0.5 °C)	
	02	-3.6 °F (-2 °C)	-1.8 °F (-1 °C)	-3.6 °F (-2 °C)	0.9 °F (0.5 °C)	
	03	-5.4 °F (-3 °C)	-1.8 °F (-1 °C)	-5.4 °F (-3 °C)	0.9 °F (0.5 °C)	
	04	-7.2 °F (-4 °C)	-1.8 °F (-1 °C)	-7.2 °F (-4 °C)	0.9 °F (0.5 °C)	
	05	-9.0 °F (-5 °C)	-1.8 °F (-1 °C)	-9.0 °F (-5 °C)	0.9 °F (0.5 °C)	
	06	-5.4 °F (-3 °C)	-0.9 °F (-0.5 °C)	-0.9 °F (-0.5 °C)	0 °F (0 °C)	
	07	-3.6 °F (-2 °C)	-0.9 °F (-0.5 °C)	-1.8 °F (-1 °C)	0 °F (0 °C)	
	08	-3.6 °F (-2 °C)	-0.9 °F (-0.5 °C)	-3.6 °F (-2 °C)	0 °F (0 °C)	
	09	-5.4 °F (-3 °C)	-0.9 °F (-0.5 °C)	-5.4 °F (-3 °C)	0 °F (0 °C)	
	10	-7.2 °F (-4 °C)	-0.9 °F (-0.5 °C)	-7.2 °F (-4 °C)	0 °F (0 °C)	
	11	-9.0 °F (-5 °C)	-0.9 °F (-0.5 °C)	-9.0 °F (-5 °C)	0 °F (0 °C)	
	12	-5.4 °F (-3 °C)	0 °F (0 °C)	-0.9 °F (-0.5 °C)	-0.9 °F (-0.5 °C)	
	13	-3.6 °F (-2 °C)	0 °F (0 °C)	-1.8 °F (-1 °C)	-0.9 °F (-0.5 °C)	
	14	-3.6 °F (-2 °C)	0 °F (0 °C)	-3.6 °F (-2 °C)	-0.9 °F (-0.5 °C)	
	15	-5.4 °F (-3 °C)	0 °F (0 °C)	-5.4 °F (-3 °C)	-0.9 °F (-0.5 °C)	
	16	-7.2 °F (-4 °C)	0 °F (0 °C)	-7.2 °F (-4 °C)	-0.9 °F (-0.5 °C)	
17	-9.0 °F (-5 °C)	0 °F (0 °C)	-9.0 °F (-5 °C)	-0.9 °F (-0.5 °C)		

13) Outdoor temperature zone boundary temperature A

Setting required if changing of the outdoor temperature setting for heat pump prohibition zone is required when auxiliary heater control by outdoor temperature 1 and 2 are performed on the indoor unit. For details, refer to "External heater output" in Chapter 6-4. ["Details of function"](#) on page 27.

Function number	Setting value	Setting description	Factory setting
66	00	-4.0 °F (-20 °C)	◆
	01	-0.4 °F (-18 °C)	
	02	3.2 °F (-16 °C)	
	03	6.8 °F (-14 °C)	
	04	10.4 °F (-12 °C)	
	05	14.0 °F (-10 °C)	
	06	17.6 °F (-8 °C)	
	07	21.2 °F (-6 °C)	
08	24.8 °F (-4 °C)		

14) Outdoor temperature zone boundary temperature B

Setting required if changing of the outdoor temperature setting for heat pump only zone is required when auxiliary heater control by outdoor temperature 1 is performed on the indoor unit. For details, refer to "External heater output" in Chapter 6-4. "[Details of function](#)" on page 27.

Function number	Setting value	Setting description	Factory setting
67	00	42.8 °F (6 °C)	◆
	01	14.0 °F (-10 °C)	
	02	17.6 °F (-8 °C)	
	03	21.2 °F (-6 °C)	
	04	24.8 °F (-4 °C)	
	05	28.4°F (-2 °C)	
	06	32.0 °F (0 °C)	
	07	35.6 °F (2 °C)	
	08	39.2 °F (4 °C)	
	09	42.8 °F (6 °C)	
	10	46.4 °F (8 °C)	
	11	50.0 °F (10 °C)	
	12	53.6 °F (12 °C)	
	13	57.2 °F (14 °C)	
	14	60.8 °F (16 °C)	
15	64.4 °F (18 °C)		

15) Standby time for auxiliary equipment operation

Sets the standby time until the auxiliary equipment operation starts during primary equipment operation.

For details, refer to Chapter 6-4. "[Details of function](#)" on page 27.

Function number	Setting value	Setting description	Factory setting
71	00	Disable	◆
	01	1 minute	
	02	2 minutes	
	•	•	
	•	•	
	•	•	
	98	98 minutes	
	99	99 minutes	

16) Heat pump backup setting

Enables or disables the heat pump backup instruction from the outdoor unit.

This function will be usable provided that the corresponding outdoor unit is connected.

Function number	Setting value	Setting description	Factory setting
72	00	Disable	◆
	01	Enable	

17) Emergency heat

Enables or disables emergency heat input.

Function number	Setting value	Setting description	Factory setting
73	00	Disable	◆
	01	Enable	

NOTE: When this function is used, IR receiver unit is necessary.

18) Fan delay time

Sets the fan delay time when the heater is turned off.

Function number	Setting value	Setting description	Factory setting
74	00	1 minute	◆
	01	50 seconds	
	02	40 seconds	
	03	30 seconds	

19) External heater use in defrosting

Enables or disables external heater use in defrosting.

NOTE: Inappropriate heater selection may cause cold air in defrosting.

Function number	Setting value	Setting description	Factory setting
75	00	Disable	◆
	01	Enable	

20) Airflow adjustment for operation mode

Strong or weak airflow can be set by $\pm 10\%$.

Since the airflow volume by motor has the upper limit and lower limit, up-down adjustment may not be performed depending on the models or settings even if this setting is performed.

Function number	Setting value	Setting description		Factory setting
		Cooling setting	Heating setting	
92	00	Standard (no change)	Standard (no change)	◆
	01	Standard (no change)	+10% up	
	02	Standard (no change)	-10% down	
	03	+10% up	Standard (no change)	
	04	+10% up	+10% up	
	05	+10% up	-10% down	
	06	-10% down	Standard (no change)	
	07	-10% down	+10% up	
	08	-10% down	-10% down	











21) Airflow adjustment at heater only operation

By selecting the heater output in the table below at heater only operation, this function adjusts the airflow volume according to the heater output to prevent cold air feeling.

Function number	Setting value	Setting description	Factory setting
		Heater output range	
93	00	No heater	◆
	01	0 — 3.4 kW (Min. CFM)	
	02	3.4 — 6.8 kW (350 CFM)	
	03	6.8 — 10.4 kW (710 CFM)	
	04	10.4 — 13.7 kW (1,070 CFM)	
	05	13.7 — 17.1 kW (1,410 CFM)	

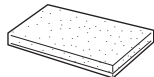
8. Accessories

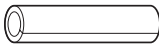
8-1. Models: AMUG24LMAS, AMUG30LMAS, AMUG36LMAS, and AMUG48LMAS

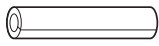
Part name	Exterior	Q'ty	Part name	Exterior	Q'ty
Operating manual		1	Cable tie (large)		4
Installation manual (indoor unit)		1	Cable tie (medium)		1
Rail		2	Cable tie (small)		1
Duct flanges		2	Drain hose insulation		1
Drain cap		2	Coupler heat insulation (large)		1
Screw		16	Coupler heat insulation (small)		1





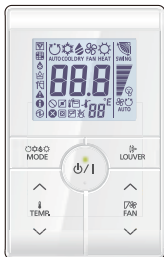
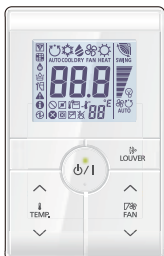
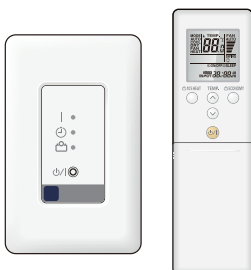

9. Optional parts

9-1. Controllers

Exterior	Part name	Model name	Summary
	Wired remote controller	UTY-RNRUZ*	Easy finger touch operation with LCD panel. Backlit LCD enables easy operation in a dark room. Wire type: Non-polar 2-wire
	Simple remote controller	UTY-RSRY	Compact remote controller concentrates on the basic functions such as Start/Stop, fan control, temperature setting, and operation mode. Wire type: Non-polar 2-wire
	Simple remote controller	UTY-RHRY	Compact remote controller concentrates on the basic functions such as Start/Stop, fan control, and temperature setting. Wire type: Non-polar 2-wire
	IR receiver kit with wireless remote controller	UTY-LBTUM	Unit control is performed by wireless remote controller.

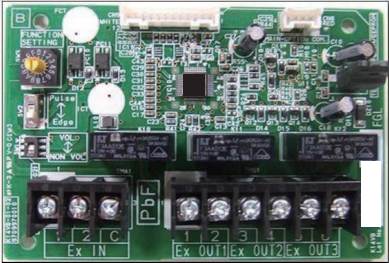
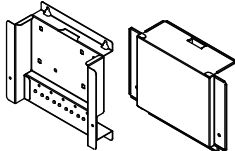
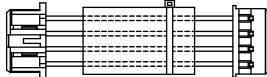
NOTE: Available functions may differ by the remote controller. For details, refer to the operation manual.

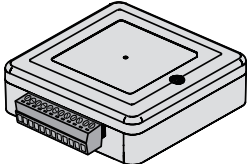
9-2. Others

Exterior	Part name	Model name	Summary
	Remote sensor unit	UTY-XSZX	Thermo-sensor for sensing the temperature of arbitrary place in the room.
	External connect kit	UTY-XWZXZG	Use to connect with various peripheral devices and air conditioner PCB. For control output port.
	External input and output PCB	UTY-XCSX	Use to connect with external devices and air conditioner PCB.
	External input and output PCB box	UTZ-GXRA	For installing the External input and output PCB.
	Wire kit	UTY-XWZXZJ	Use to connect with external input and output PCB and Indoor unit PCB.
	Wireless LAN adapter	UTY-TFSXZ2	Remotely manage an air conditioning system using mobile devices such as smartphones and tablets. For connection indoor unit with UART interface.
	Thermostat converter	UTY-TTRX	This converter can control Fujitsu General products using a third-party thermostat controller.
	Split system converter	UTY-VTGX	This converter is required when connecting single split system to VRF network system.

NOTE: Combined use of following optional parts and Wireless LAN adapter (UTY-TFSXZ2) is not allowed.

- External input and output PCB (UTY-XCSX)
- Thermostat converter

Part 2. OUTDOOR UNIT

SINGLE TYPE:

AOU24RGLX

AOU30RGLX

AOUG36LMAS1

AOUG48LMAS1

1. Specifications

Type			Inverter heat pump	
Model name			AOU24RGLX	AOU30RGLX
Power supply			208/230 V ~ 60 Hz	
Power supply intake			Outdoor unit	
Available voltage range			187—253 V	
Starting current			9.6	11.5
Fan	Airflow rate	Cooling	2,119 (3,600)	
		Heating	2,119 (3,600)	
	Type × Q'ty	Propeller × 1		
Motor output		W	100	
Sound pressure level *	Cooling		53	
	Heating		55	
Heat exchanger type	Dimensions (H × W × D)	in	31-7/16 × 35-7/16 × 1-7/16	
		mm	798 × 900 × 36.4	
	Fin pitch	FPI	20	
	Rows × Stages		2 × 38	
	Pipe type		Copper	
	Fin	Type (Material)	Aluminum	
		Surface treatment	PC Fin	
Compressor	Type × Q'ty		DC twin rotary × 1	
	Motor output		W	2,100
Refrigerant	Type		R410A	
	Charge	lb oz	4 lb 10 oz	
		g	2,100	
Refrigerant oil	Type		POE (RB68)	
	Amount	in ³ (cm ³)	48.8 (800)	
Enclosure	Material		Steel	
	Color		Beige Approximate color of Munsell 10YR 7.5/1.0	
Dimensions (H × W × D)	Net		in (mm)	32-11/16 × 35-7/16 × 13 (830 × 900 × 330)
	Gross		in (mm)	39-3/8 × 41-5/16 × 17-1/2 (1,000 × 1,050 × 445)
Weight	Net		lb (kg)	134 (61)
	Gross			152 (69)
Connection pipe	Size	Liquid	in (mm)	Ø3/8 (9.52)
		Gas		Ø5/8 (15.88)
	Method		Flare	
	Pre-charge length		66 (20)	
	Max. length		ft (m)	164 (50)
Max. height difference		98 (30)		
Operation range	Cooling		-4 to 115 (-20 to 46)	
	Heating		-4 to 75 (-20 to 24)	
Drain hose	Material		LDPE	
	Size		in (mm)	Ø1/2 (13.0) [I.D.], Ø5/8 to Ø11/16 (16.0 to 16.7) [O.D.]

NOTES:

- Specifications are based on the following conditions:
 - Cooling: Indoor temperature of 80 °FDB (26.67 °CDB) / 67 °FWB (19.44 °CWB), and outdoor temperature of 95 °FDB (35 °CDB) / 75 °FWB (23.9 °CWB).
 - Heating: Indoor temperature of 70 °FDB (21.11 °CDB) / 59 °FWB (15 °CWB), and outdoor temperature of 47 °FDB (8.33 °CDB) / 43 °FWB (6.11 °CWB).
 - Pipe length: 24 ft 6 in (7.5 m), Height difference: 0 ft (0 m). (Between outdoor unit and indoor unit.)
- Protective function might work when using it outside the operation range.
- *: Sound pressure level
 - Measured values in manufacturer's anechoic chamber.
 - Because of the surrounding sound environment, the sound levels measured in actual installation conditions might be higher than the specified values here.

Type			Inverter heat pump	
Model name			AOUG36LMAS1	AOUG48LMAS1
Power supply			208/230 V ~ 60 Hz	
Power supply intake			Outdoor unit	
Available voltage range			187—253 V	
Starting current			20.1	
Fan	Airflow rate	Cooling	CFM (m ³ /h)	
		Heating		
	Type × Q'ty		2,590 (4,400)	
Motor output			Propeller × 1	
			111	
Sound pressure level *	Cooling	dB (A)	53	54
	Heating		54	55
Heat exchanger type	Dimensions (H × W × D)	in	38-1/16 × 36-5/16 × 2-3/16	
		mm	966 × 922 × 55	
	Fin pitch	FPI	18	
	Rows × Stages		3 × 46	
	Pipe type		Copper	
	Fin	Type (Material)	Aluminum	
	Surface treatment	Blue Fin		
Compressor	Type × Q'ty		DC twin rotary × 1	
	Motor output	W	2,100	
Refrigerant	Type		R410A	
	Charge	lb oz	9 lb 8 oz	
		g	4,300	
Refrigerant oil	Type		POE (RB68)	
	Amount	in ³ (cm ³)	70.2 (1,150)	
Enclosure	Material		Steel	
	Color		Beige Approximate color of Munsell 10YR 7.5/1.0	
Dimensions (H × W × D)	Net	in (mm)	39-5/16 × 38-3/16 × 14-9/16 (998 × 970 × 370)	
	Gross	in (mm)	45-12/16 × 41-14/16 × 18-13/16 (1,162 × 1,064 × 478)	
Weight	Net	lb (kg)	198 (90)	
	Gross		220 (100)	
Connection pipe	Size	Liquid	in (mm)	
		Gas	Ø3/8 (9.52)	
	Method		Ø5/8 (15.88)	
	Pre-charge length		Flare	
	Max. length		98 (30)	
Max. height difference		ft (m)	230 (70)	
Operation range	Cooling	°F (°C)	14 to 115 (-10 to 46)	
	Heating		-4 to 75 (-20 to 24)	
Drain hose	Material		LDPE	
	Size	in (mm)	Ø1/2 (13.0) [I.D.], Ø5/8 to Ø11/16 (16.0 to 16.7) [O.D.]	
NOTES:				
<ul style="list-style-type: none"> Specifications are based on the following conditions: <ul style="list-style-type: none"> Cooling: Indoor temperature of 80 °FDB (26.67 °CDB) / 67 °FWB (19.44 °CWB), and outdoor temperature of 95 °FDB (35 °CDB) / 75 °FWB (23.9 °CWB). Heating: Indoor temperature of 70 °FDB (21.11 °CDB) / 59 °FWB (15 °CWB), and outdoor temperature of 47 °FDB (8.33 °CDB) / 43 °FWB (6.11 °CWB). Pipe length: 24 ft 6 in (7.5 m), Height difference: 0 ft (0 m). (Between outdoor unit and indoor unit.) Protective function might work when using it outside the operation range. *: Sound pressure level <ul style="list-style-type: none"> Measured values in manufacturer's anechoic chamber. Because of the surrounding sound environment, the sound levels measured in actual installation conditions might be higher than the specified values here. 				

2. Dimensions

2-1. Models: AOU24RGLX and AOU30RGLX

Unit: in (mm)

OUTDOOR UNIT
AOU24-30RGLX,
AOU36-48LMAS1

OUTDOOR UNIT
AOU24-30RGLX,
AOU36-48LMAS1

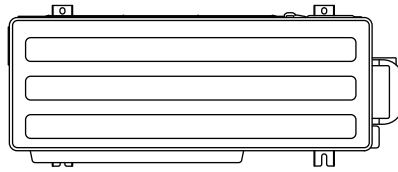

Top view

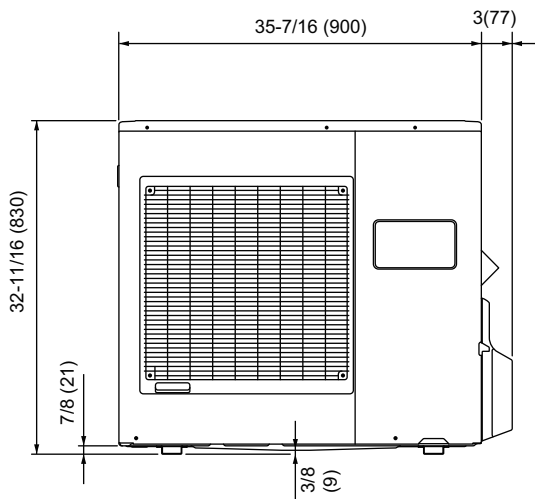

Front view

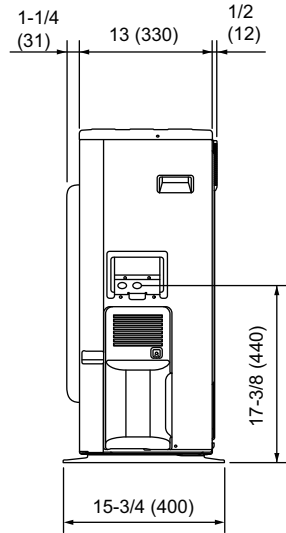

Side view

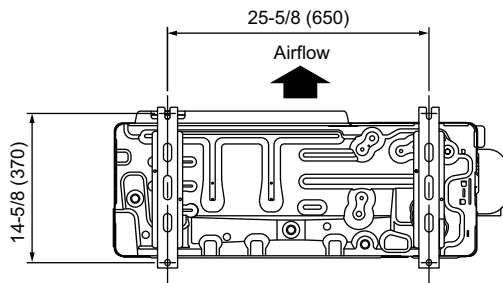

Bottom view

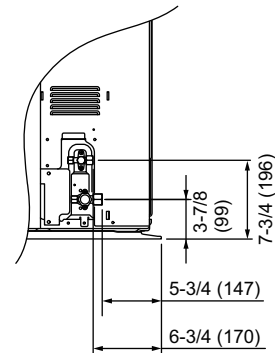

2-2. Models: AOUG36LMAS1 and AOUG48LMAS1

Unit: in (mm)

OUTDOOR UNIT
AOU24-30RGLX,
AOUG36-48LMAS1

OUTDOOR UNIT
AOU24-30RGLX,
AOUG36-48LMAS1

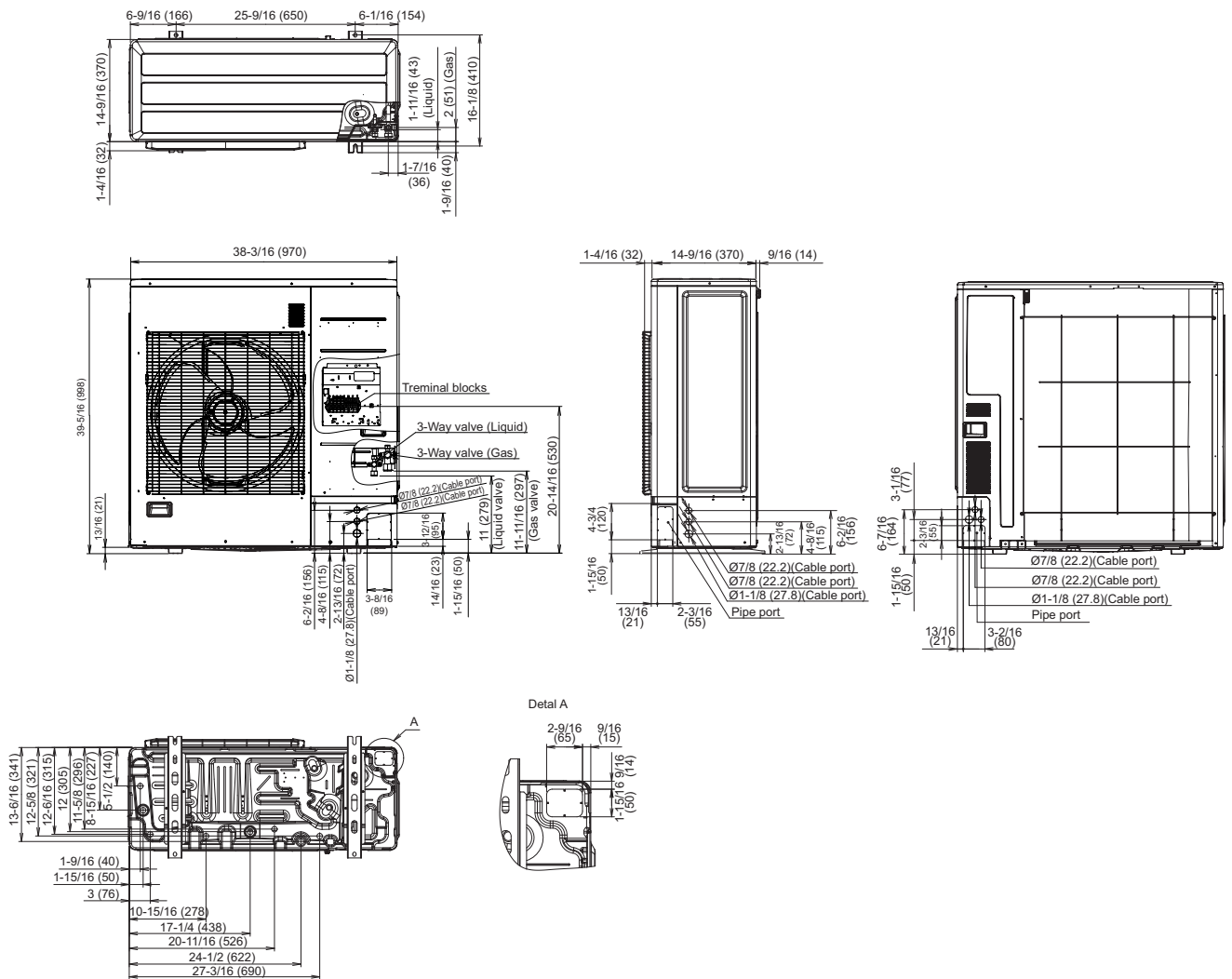

3. Installation space

3-1. Models: AOU24RGLX and AOU30RGLX

■ Space requirement

Provide sufficient installation space for product safety.

● Single outdoor unit installation

- When the upper space is open:

Unit: in (mm)

When there are obstacles at the rear only.

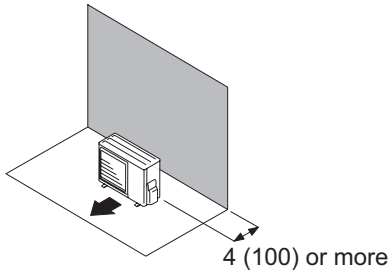

When there are obstacles at the rear and sides.

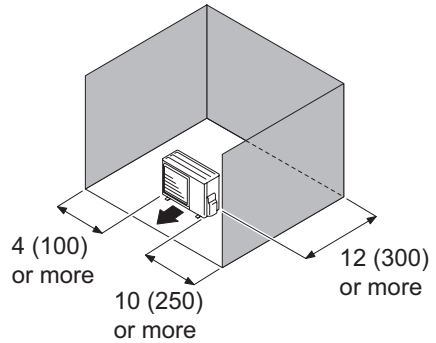

When there are obstacles at the front only.

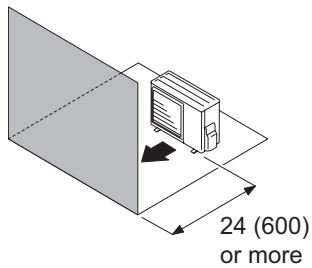

When there are obstacles at the front and rear.

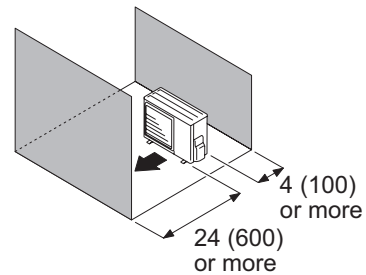

- When there is an obstruction in the upper space:

Unit: in (mm)

When there are obstacles at the rear and above.

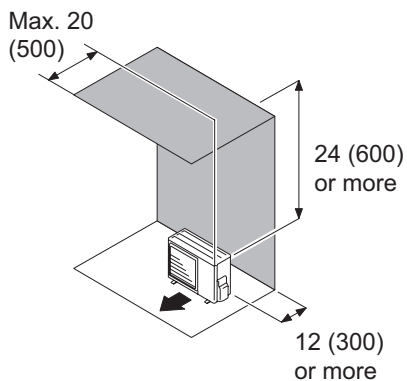

When there are obstacles at the rear, sides, and above.

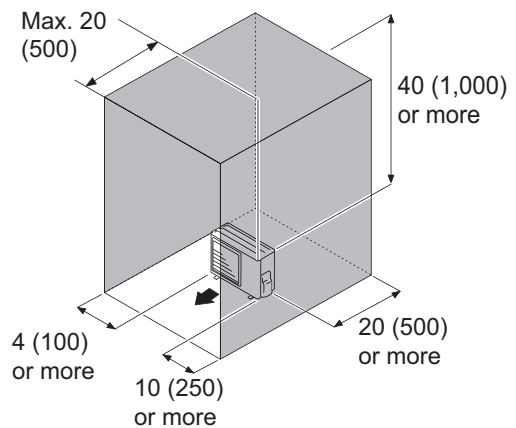

● Multiple outdoor unit installation

- When the upper space is open:

Unit: in (mm)

When there are obstacles at the rear only.

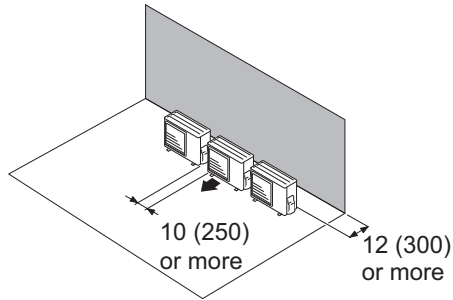

When there are obstacles at the front only.

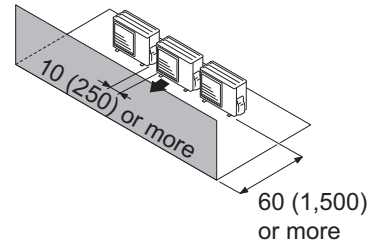

When there are obstacles at the front and rear.

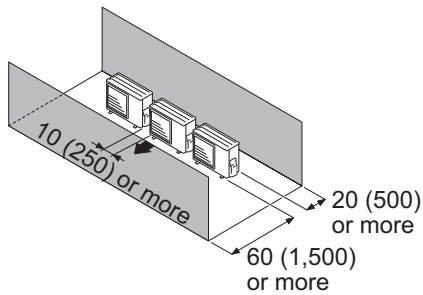

- When there is an obstruction in the upper space:

Unit: in (mm)

When there are obstacles at the rear and above.

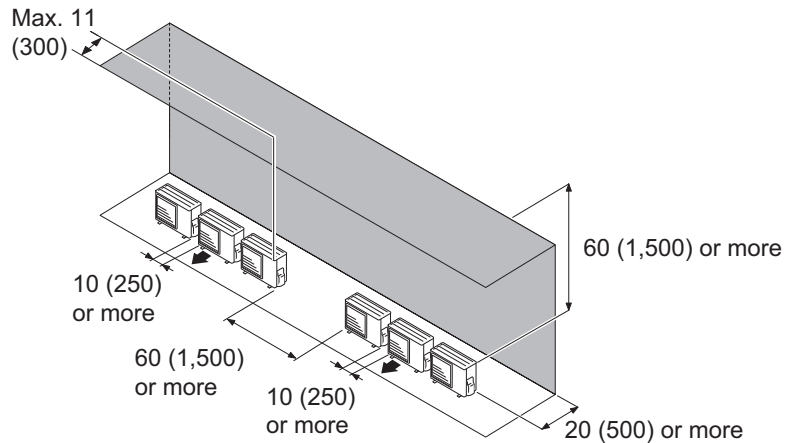

OUTDOOR UNIT
AOU24-30RGLX,
AOUG36-48LMAS1

OUTDOOR UNIT
AOU24-30RGLX,
AOUG36-48LMAS1

● Outdoor unit installation in multi-row

Unit: in (mm)

Single parallel unit arrangement

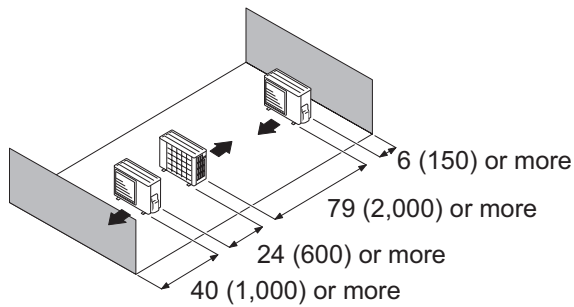

Multiple parallel unit arrangement

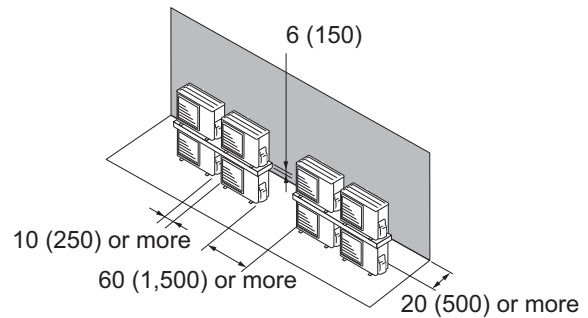
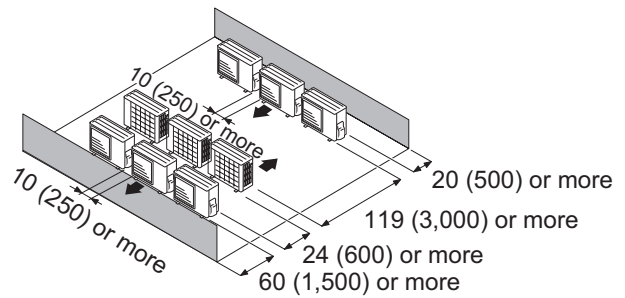

NOTES:

- If the space is larger than stated above, the condition will be the same as when there is no obstacle.
- Height above the floor level should be 2 in (50 mm) or more.
- When installing the outdoor unit, be sure to open the front and left side to obtain better operation efficiency.

⚠ CAUTION

- Do not install the outdoor unit in two-stage where the drain water could freeze. Otherwise the drainage from the upper unit may form ice and cause a malfunction of the lower unit.
- When the outdoor temperature is 32 °F (0 °C) or less, do not use the accessory drain pipe and drain cap. If the drain pipe and drain cap are used, the drain water in the pipe may freeze in extremely cold climate. (For reverse cycle model only.)
- In area with heavy snowfall, if the inlet and outlet of the outdoor unit is blocked with snow, it might become difficult to get warm, and it is likely to cause product malfunction. Construct a canopy and a pedestal, or place the unit on a high stand that is locally installed.

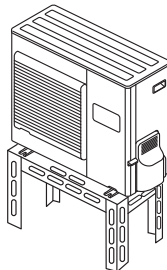

3-2. Models: AOUG36LMAS1 and AOUG48LMAS1

⚠ CAUTION

- The installation space shown in the following examples is based on an ambient temperature under cooling operation of 95°FDB (35°CDB) at the air intake of the outdoor unit. Provide more space around the air intake than shown in the examples if the ambient temperature exceeds 95°FDB (35°CDB) or if the thermal load of all of the outdoor units exceeds the capacity.
- Consider the transportation route, installation space, maintenance space, and access, and install the unit in a location with sufficient space for the refrigerant piping.
- Observe the installation space specifications that are shown in the figures. Provide the same space for the air intake at the rear of the outdoor unit.

If the installation is not performed according to the specifications, it could cause a short circuit and result in a lack of operating performance. As a result, the outdoor unit might easily be stopped by high-pressure protection.

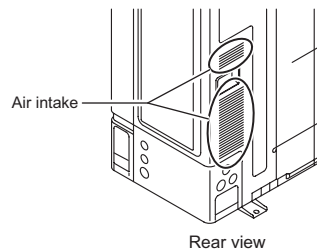

- Installation methods not shown in the following examples are not recommended. Performance may drop significantly.

Space requirement

Provide sufficient installation space for product safety.

Single outdoor unit installation

- When the upper space is open:

Unit: in (mm)

When there are obstacles at the rear only.

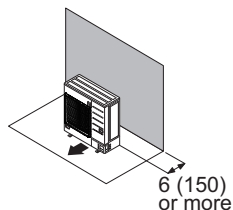

When there are obstacles at the rear and sides.

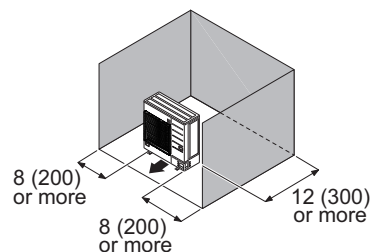

When there are obstacles at the front only.

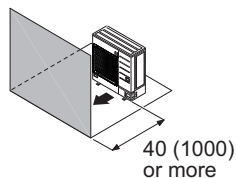

When there are obstacles at the front and rear.

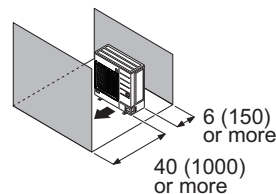

- When there is an obstruction in the upper space:

Unit: in (mm)

When there are obstacles at the rear and above.

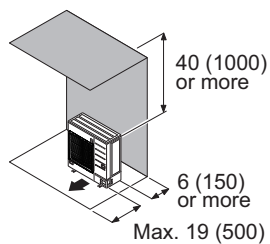

When there are obstacles at the rear, sides, and above.

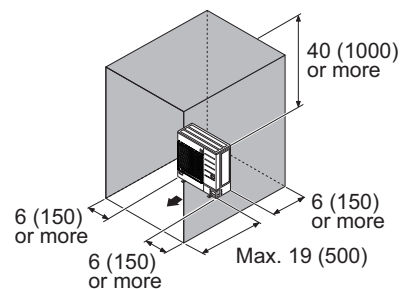

● Multiple outdoor unit installation

NOTES:

- Provide at least of space between the outdoor units if multiple units are installed.
- When routing the piping from the side of an outdoor unit, provide space for the piping.
- No more than 3 units must be installed side by side.
When 3 units or more are arranged in a line, provide the space as shown in the following example when an obstruction is present also in the upward area.
- **When the upper space is open:**

Unit: in (mm)

When there are obstacles at the rear only.

When there are obstacles at the front only.

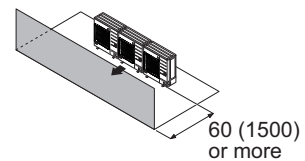
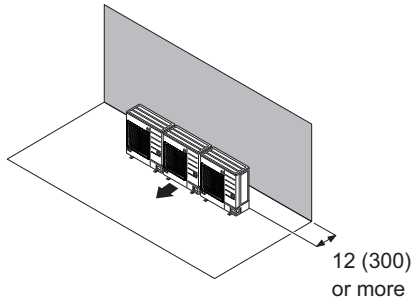

When there are obstacles at the front and rear.

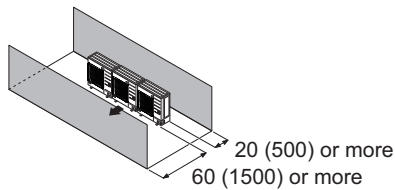

- **When there is an obstruction in the upper space:**

Unit: in (mm)

When there are obstacles at the rear and above.

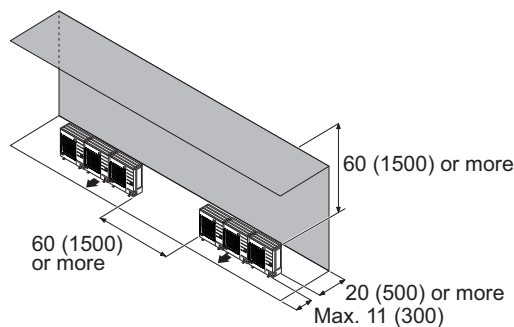

● Outdoor unit installation in multi-row

Unit: in (mm)

Single parallel unit arrangement

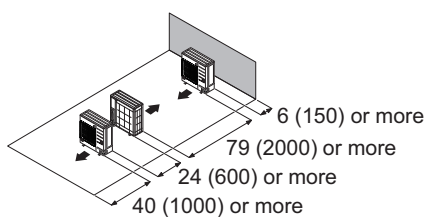

Multiple parallel unit arrangement

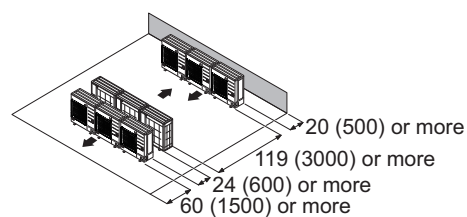

NOTES:

- If the space is larger than stated above, the condition will be the same as when there is no obstacle.
- Height above the floor level should be 2 in (50 mm) or more.
- When installing the outdoor unit, be sure to open the front and left side to obtain better operation efficiency.

4. Refrigerant circuit

4-1. Models: AOU24RGLX and AOU30RGLX

OUTDOOR UNIT
AOU24-30RGLX,
AOU36-48LMAS1

OUTDOOR UNIT
AOU24-30RGLX,
AOU36-48LMAS1

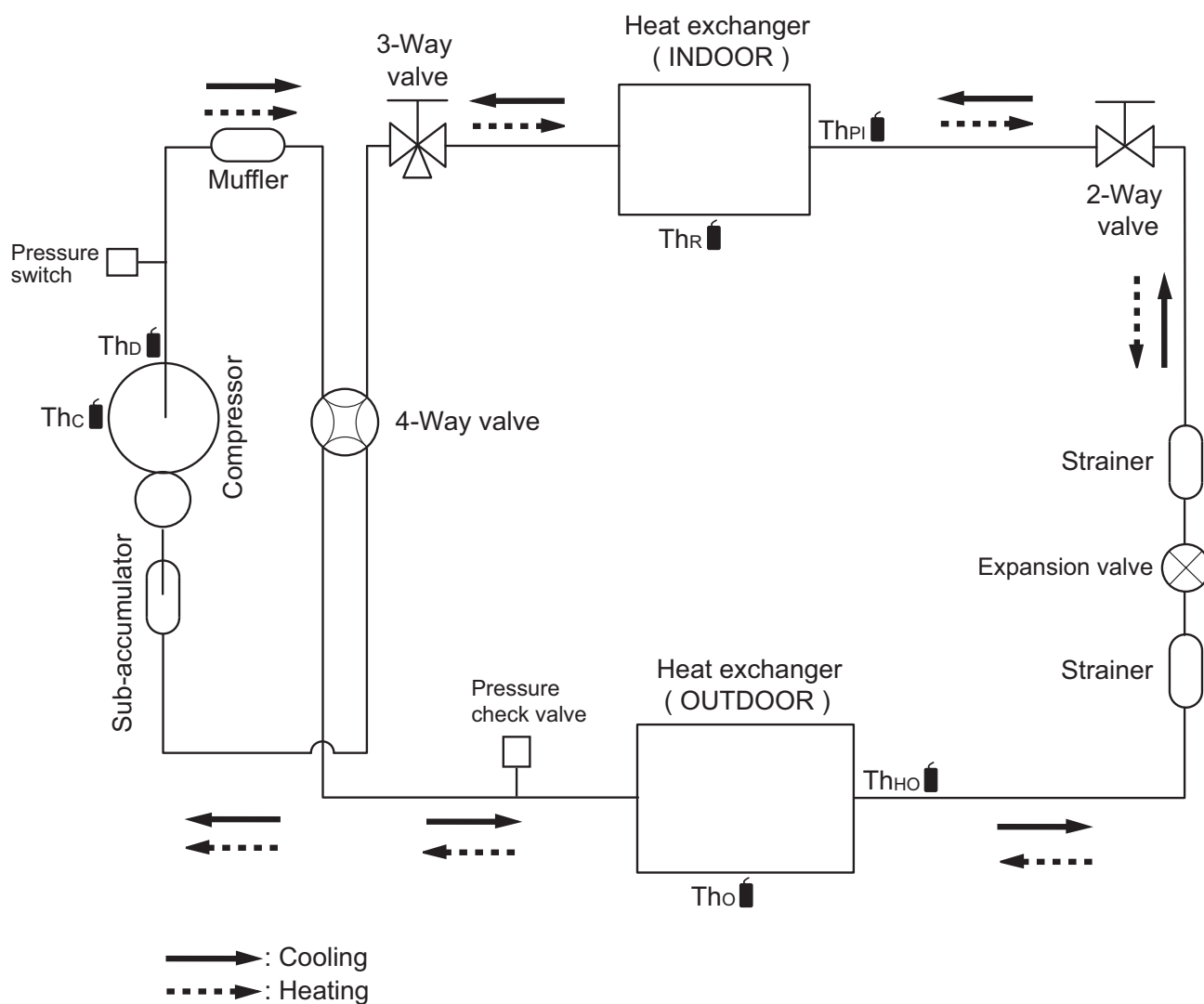



Th_c  : Thermistor (Compressor temperature)

Th_D  : Thermistor (Discharge temperature)

Th_o  : Thermistor (Outdoor temperature)

Th_{HO}  : Thermistor (Heat exchanger Out temperature)

Th_R  : Thermistor (Room temperature)

Th_{PI}  : Thermistor (Pipe temperature)

4-2. Models: AOUG36LMAS1 and AOUG48LMAS1

OUTDOOR UNIT
AOU24-30RGLX,
AOUG36-48LMAS1

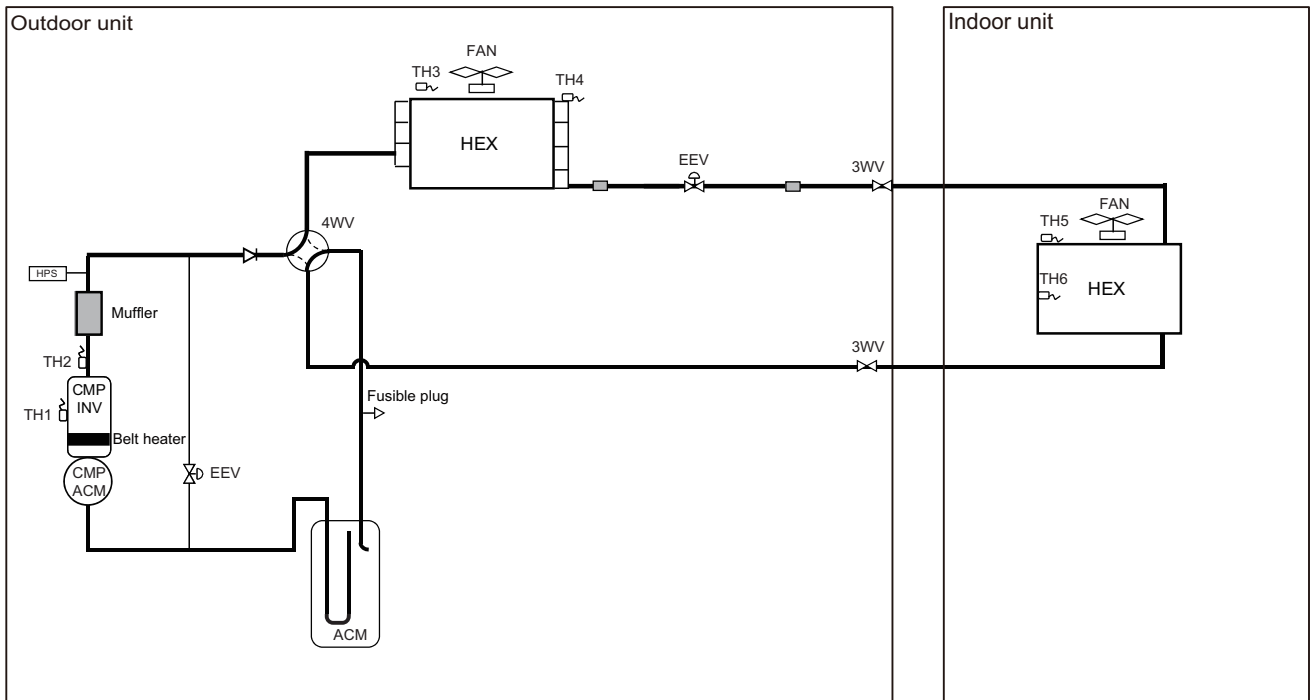

OUTDOOR UNIT
AOU24-30RGLX,
AOUG36-48LMAS1

- | | | | |
|-----|------------------------------|-----|---|
| ▷ | : Check valve | TH1 | : Thermistor (Shell) |
| ■ | : Strainer | TH2 | : Thermistor (Discharge temperature thermistor) |
| CMP | : Compressor (Inverter type) | TH3 | : Thermistor (Outdoor temperature) |
| HEX | : Heat exchanger | TH4 | : Thermistor (Heat Exchanger Out temperature) |
| ACM | : Accumulator | TH5 | : Thermistor (Room temperature) |
| HPS | : High pressure sensor | TH6 | : Thermistor (Heat Exchanger Med temperature) |
| 4WV | : 4-way valve | | |
| 3WV | : 3-way valve | | |
| EEV | : Electric expansion valve | | |

5. Wiring diagrams

5-1. Models: AOU24RGLX and AOU30RGLX

OUTDOOR UNIT
AOU24-30RGLX,
AOUG36-48LMAS1

OUTDOOR UNIT
AOU24-30RGLX,
AOUG36-48LMAS1

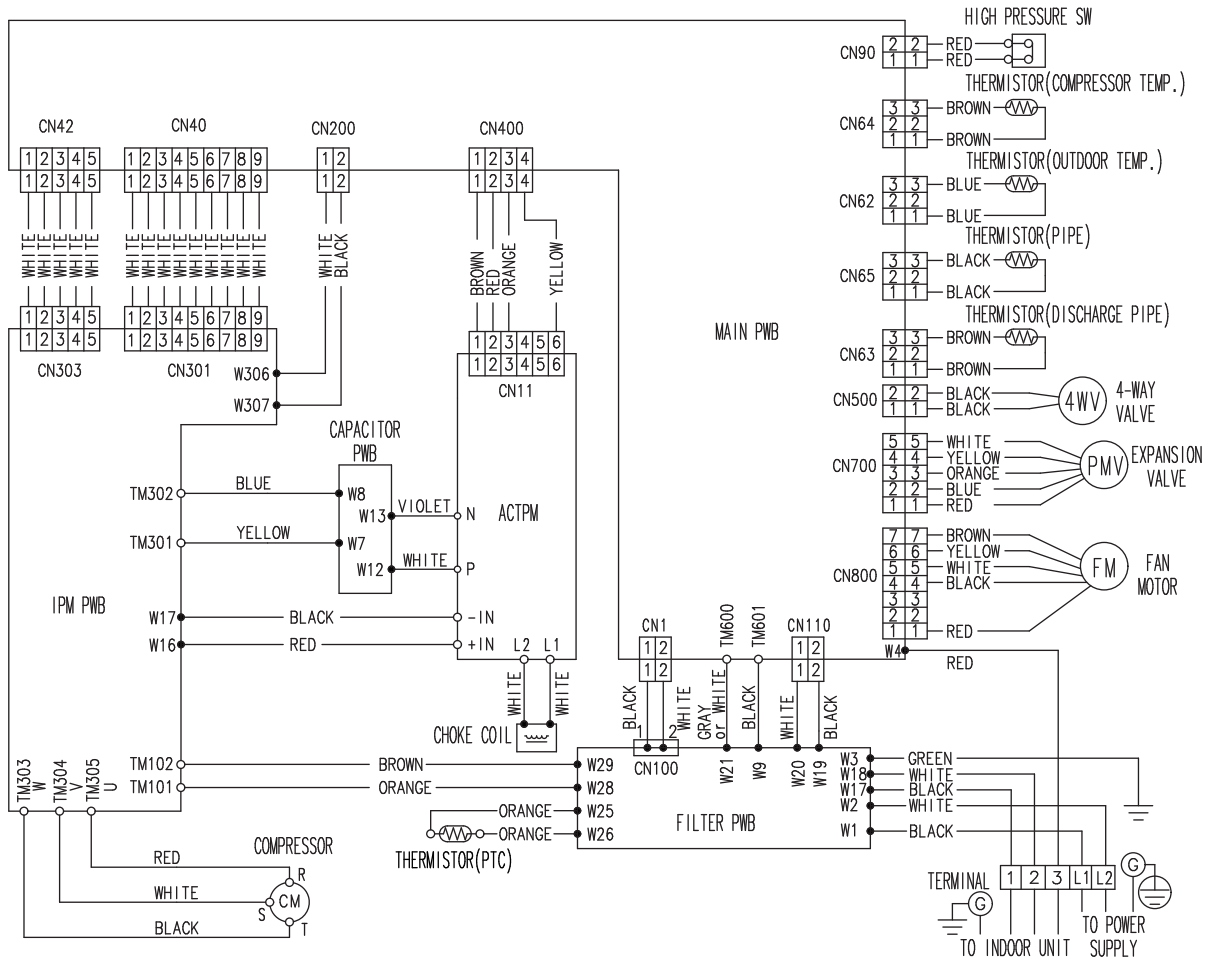

5-2. Models: AOUG36LMAS1 and AOUG48LMAS1

OUTDOOR UNIT
AOU24-30RGLX,
AOUG36-48LMAS1

OUTDOOR UNIT
AOU24-30RGLX,
AOUG36-48LMAS1

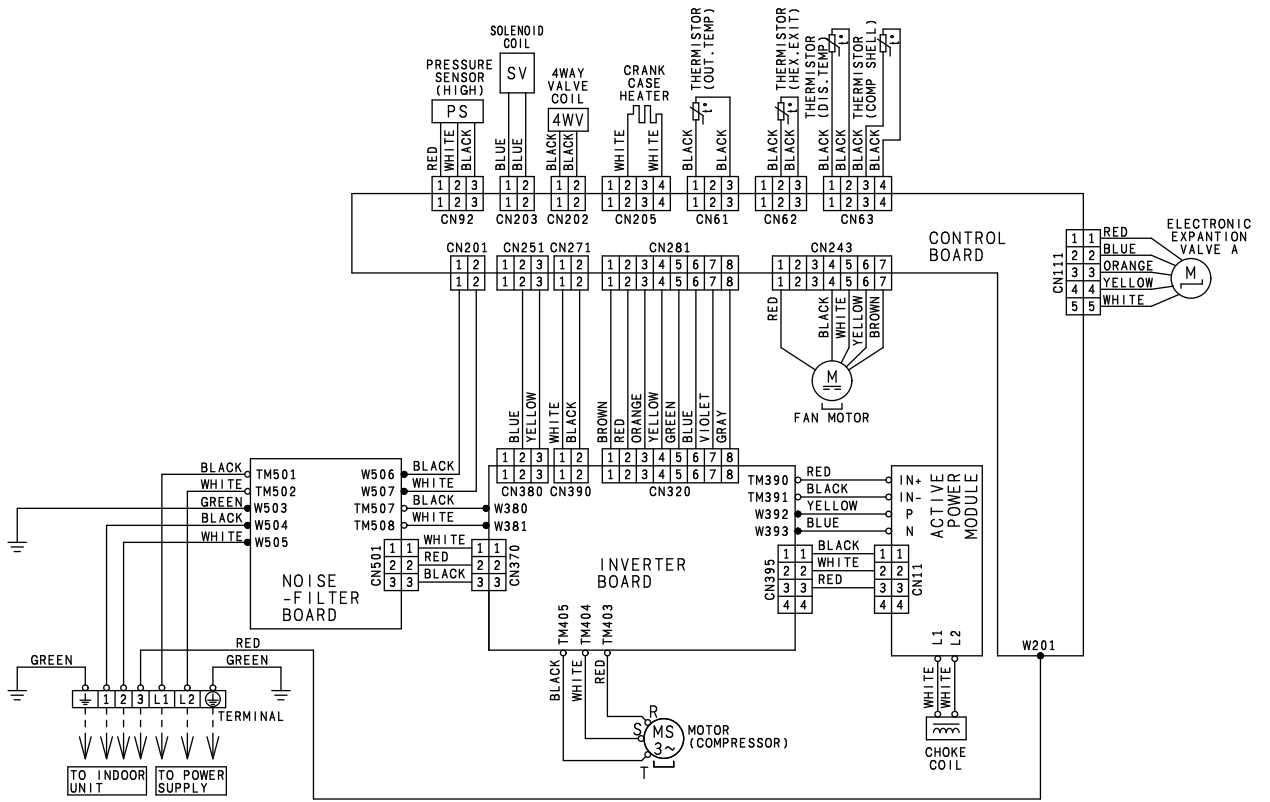

6. Capacity compensation rate for pipe length and height difference

OUTDOOR UNIT
AOU24-30RGLX,
AOUG36-48LMAS1

OUTDOOR UNIT
AOU24-30RGLX,
AOUG36-48LMAS1

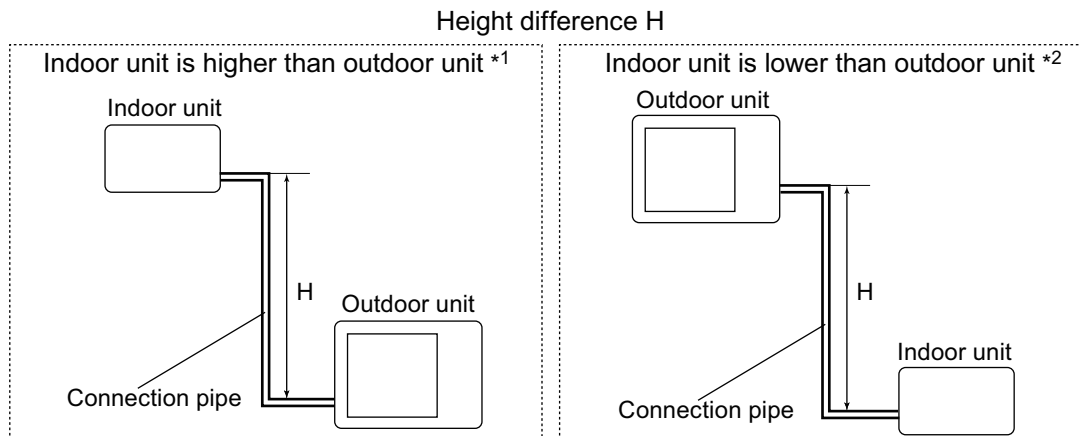

6-1. Models: AOU24RGLX and AOU30RGLX

NOTE: Values mentioned in the table are calculated based on the maximum capacity.

COOLING		Pipe length								
		m	5	7.5	10	20	30	40	50	
		ft	16	24	32	65	98	131	164	
Height difference H	Indoor unit is higher than outdoor unit *1	30	98	—	—	—	—	0.913	0.899	0.881
		20	65	—	—	—	0.941	0.929	0.914	0.896
		10	32	—	—	0.974	0.957	0.944	0.930	0.911
		7.5	24	—	0.988	0.978	0.960	0.948	0.934	0.914
		5	16	0.998	0.992	0.982	0.964	0.952	0.938	0.919
Height difference H	Indoor unit is lower than outdoor unit *2	0	0	1.000	1.000	0.989	0.972	0.960	0.945	0.926
		-5	-16	1.000	1.000	0.989	0.972	0.960	0.945	0.926
		-7.5	-24	—	1.000	0.989	0.972	0.960	0.945	0.926
		-10	-32	—	—	0.989	0.972	0.960	0.945	0.926
		-20	-65	—	—	—	0.972	0.960	0.945	0.926
		-30	-98	—	—	—	0.960	0.945	0.926	

HEATING		Pipe length								
		m	5	7.5	10	20	30	40	50	
		ft	16	24	32	65	98	131	164	
Height difference H	Indoor unit is higher than outdoor unit *1	30	98	—	—	—	—	0.939	0.922	0.907
		20	65	—	—	—	0.963	0.939	0.922	0.907
		10	32	—	—	0.999	0.963	0.939	0.922	0.907
		7.5	24	—	1.000	0.999	0.963	0.939	0.922	0.907
		5	16	1.000	1.000	0.999	0.963	0.939	0.922	0.907
Height difference H	Indoor unit is lower than outdoor unit *2	0	0	1.000	1.000	0.999	0.963	0.939	0.922	0.907
		-5	-16	1.000	0.995	0.995	0.958	0.934	0.917	0.903
		-7.5	-24	—	0.983	0.992	0.955	0.932	0.915	0.900
		-10	-32	—	—	0.990	0.953	0.929	0.912	0.898
		-20	-65	—	—	—	0.943	0.920	0.903	0.889
		-30	-98	—	—	—	0.911	0.894	0.880	

6-2. Models: AOUG36LMAS1 and AOUG48LMAS1

NOTE: Values mentioned in the table are calculated based on the maximum capacity.

COOLING		Pipe length										
		m		5	7.5	10	20	30	40	50	60	70
		ft	16	24	32	65	98	131	164	196	229	
Height difference H	Indoor unit is higher than outdoor unit *1	30	98	—	—	—	—	0.885	0.842	0.800	0.754	0.711
		20	65	—	—	—	0.937	0.895	0.852	0.810	0.770	0.728
		10	32	—	—	0.990	0.947	0.905	0.862	0.822	0.780	0.738
		7.5	24	—	0.993	0.993	0.950	0.908	0.865	0.824	0.782	0.740
		5	16	0.995	0.995	0.995	0.952	0.910	0.867	0.825	0.779	0.736
		0	0	1.000	1.000	1.000	0.957	0.915	0.872	0.830	0.784	0.741
	Indoor unit is lower than outdoor unit *2	-5	-16	1.000	1.000	1.000	0.957	0.915	0.872	0.830	0.784	0.741
		-7.5	-24	—	1.000	1.000	0.957	0.915	0.872	0.830	0.784	0.741
		-10	-32	—	—	1.000	0.957	0.915	0.872	0.830	0.784	0.741
		-20	-65	—	—	—	0.957	0.915	0.872	0.830	0.784	0.741
-30		-98	—	—	—	—	0.915	0.872	0.830	0.784	0.741	

HEATING		Pipe length										
		m		5	7.5	10	20	30	40	50	60	70
		ft	16	24	32	65	98	131	164	196	229	
Height difference H	Indoor unit is higher than outdoor unit *1	30	98	—	—	—	—	0.995	0.993	0.990	0.853	0.828
		20	65	—	—	—	0.998	0.995	0.993	0.990	0.853	0.828
		10	32	—	—	1.000	0.998	0.995	0.993	0.990	0.853	0.828
		7.5	24	—	1.000	1.000	0.998	0.995	0.993	0.990	0.853	0.828
		5	16	1.000	1.000	1.000	0.998	0.995	0.993	0.990	0.853	0.828
		0	0	1.000	1.000	1.000	0.998	0.995	0.993	0.990	0.853	0.828
	Indoor unit is lower than outdoor unit *2	-5	-16	1.000	1.000	0.995	0.993	0.990	0.988	0.985	0.848	0.823
		-7.5	-24	—	1.000	0.992	0.990	0.987	0.985	0.982	0.845	0.820
		-10	-32	—	—	0.990	0.988	0.985	0.983	0.980	0.843	0.818
		-20	-65	—	—	—	0.978	0.975	0.973	0.970	0.833	0.808
-30		-98	—	—	—	—	0.965	0.963	0.960	0.823	0.798	

OUTDOOR UNIT
 AOUG36-48LMAS1

OUTDOOR UNIT
 AOUG36-48LMAS1

7. Additional charge calculation

7-1. Models: AOU24RGLX and AOU30RGLX

Refrigerant type		R410A
Refrigerant amount	lb oz	4 lb 10 oz
	g	2,100

■ Refrigerant charge

Total pipe length	ft	66 or less	98	131	164 (Max.)	0.43 oz/ft (40 g/m)
	m	20 or less	30	40	50 (Max.)	
Additional charge	oz	0	14.1	28.2	42.3	
	g	0	400	800	1,200	

7-2. Models: AOUG36LMAS1 and AOUG48LMAS1

Refrigerant type		R410A
Refrigerant amount	lb oz	9 lb 8 oz
	g	4,300

■ Refrigerant charge

Total pipe length	ft	98 or less	131	164	196	230 (Max.)	0.43 oz/ft (40 g/m)
	m	30 or less	40	50	60	70 (Max.)	
Additional charge	oz	0	14.1	28.2	42.3	56.4	
	g	0	400	800	1,200	1,600	

8. Airflow

8-1. Model: AOU24RGLX

● Cooling

m ³ /h	3,600
l/s	1,000
CFM	2,119

● Heating

m ³ /h	3,600
l/s	1,000
CFM	2,119

8-2. Model: AOU30RGLX

● Cooling

m ³ /h	3,600
l/s	1,000
CFM	2,119

● Heating

m ³ /h	3,600
l/s	1,000
CFM	2,119

8-3. Model: AOUG36LMAS1

● Cooling

m ³ /h	4,400
l/s	1,222
CFM	2,590

● Heating

m ³ /h	4,400
l/s	1,222
CFM	2,590

8-4. Model: AOUG48LMAS1

● Cooling

m ³ /h	4,400
l/s	1,222
CFM	2,590

● Heating

m ³ /h	4,400
l/s	1,222
CFM	2,590

9. Operation noise (sound pressure)

9-1. Noise level curve

Model: AOU24RGLX

Cooling

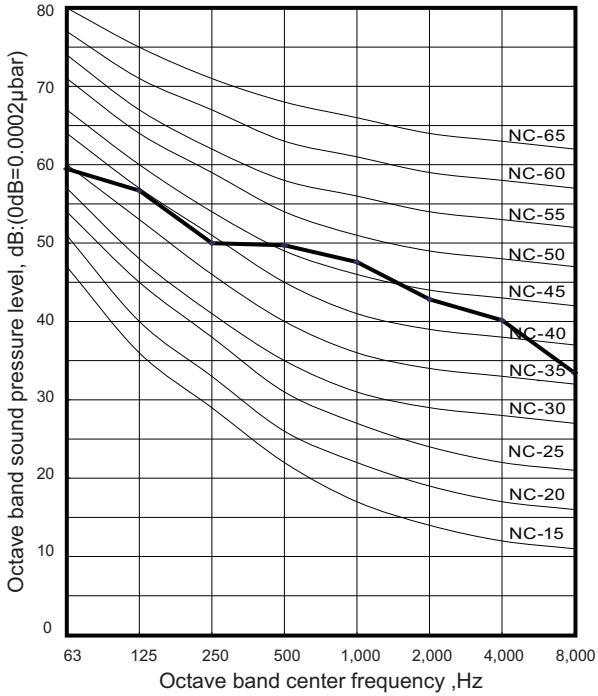

Heating

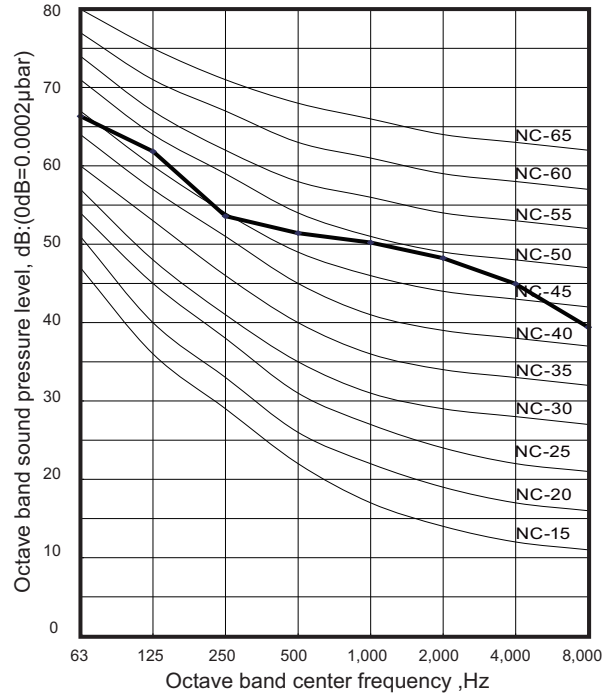

Model: AOU30RGLX

Cooling

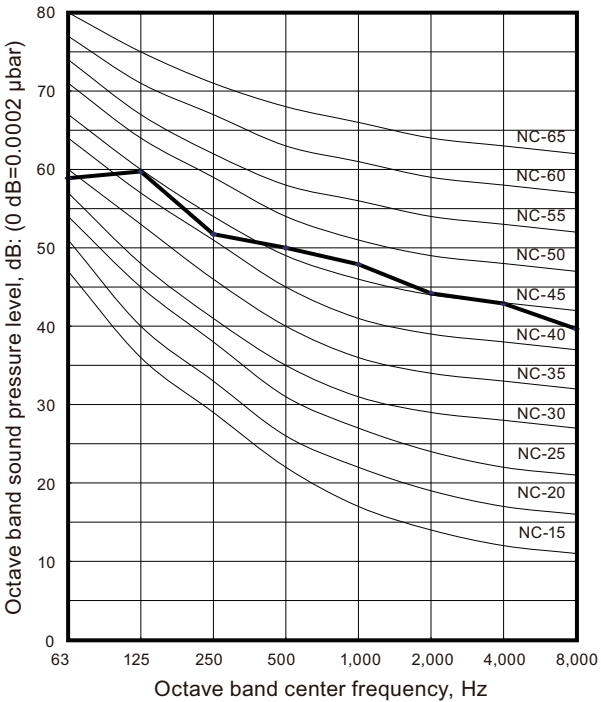

Heating

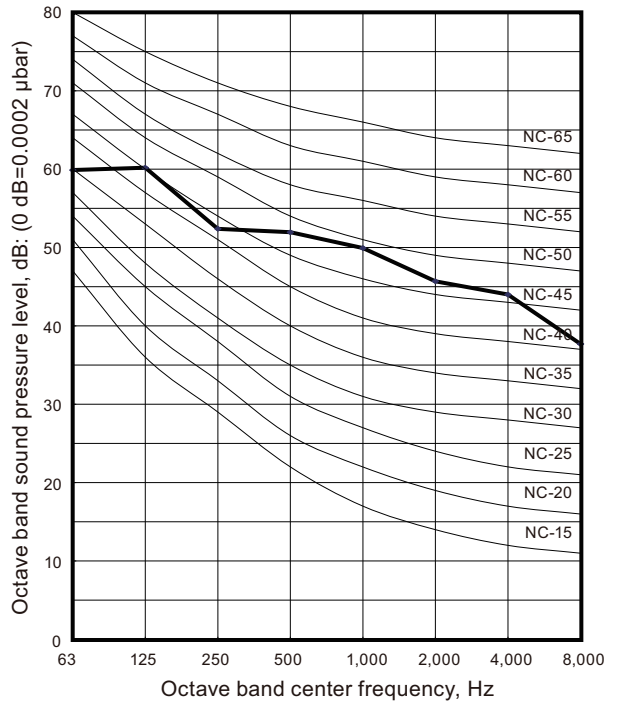

OUTDOOR UNIT
AOU24-30RGLX,
AOU36-48LWAS1

OUTDOOR UNIT
AOU24-30RGLX,
AOU36-48LWAS1

Model: AOUG36LMAS1

Cooling

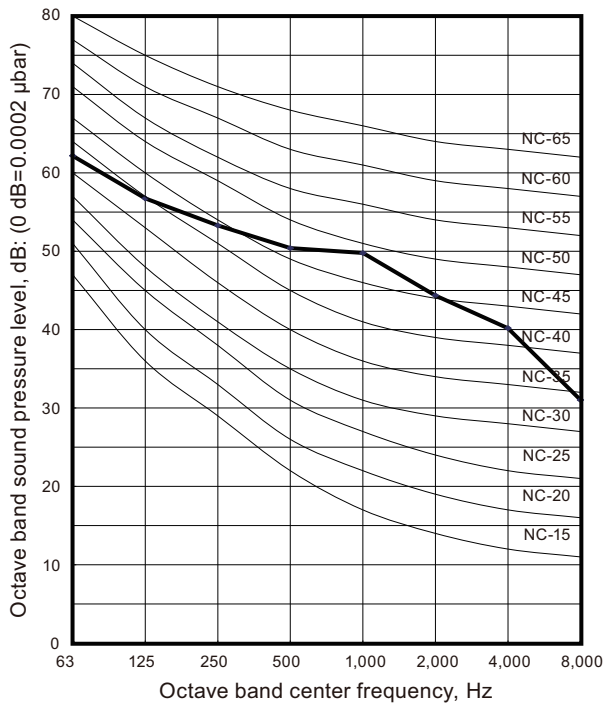

Heating

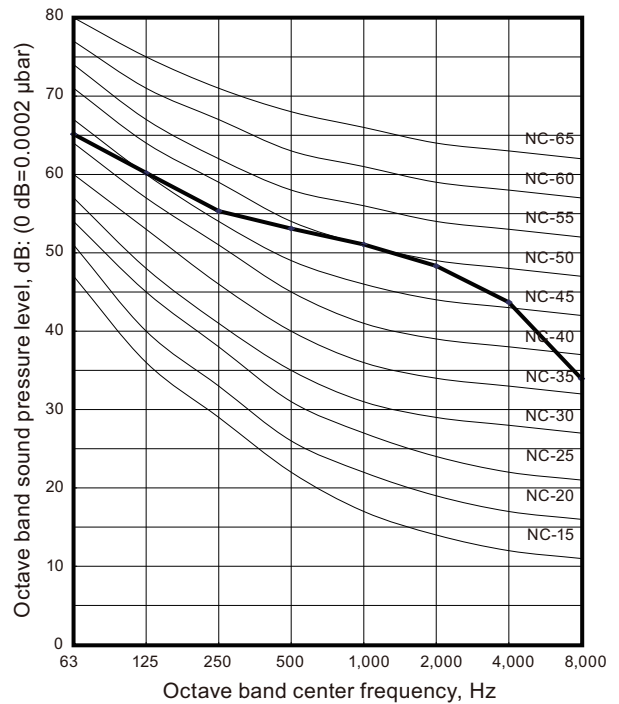

OUTDOOR UNIT
AOU24-30RGLX,
AOUG36-48LMAS1

OUTDOOR UNIT
AOU24-30RGLX,
AOUG36-48LMAS1

Model: AOUG48LMAS1

Cooling

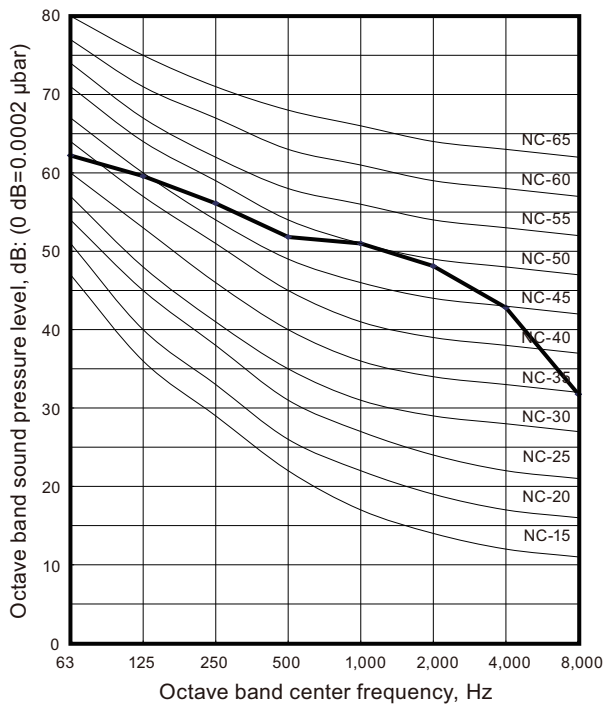

Heating

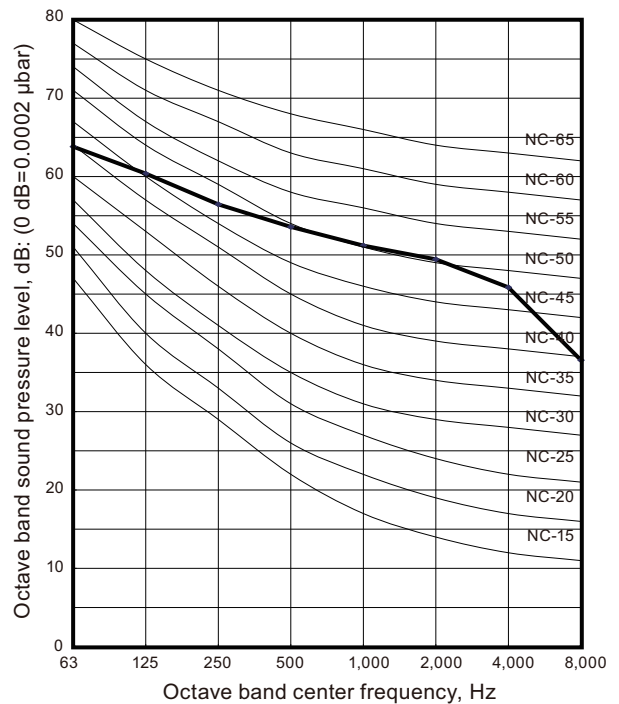

9-2. Sound level check point

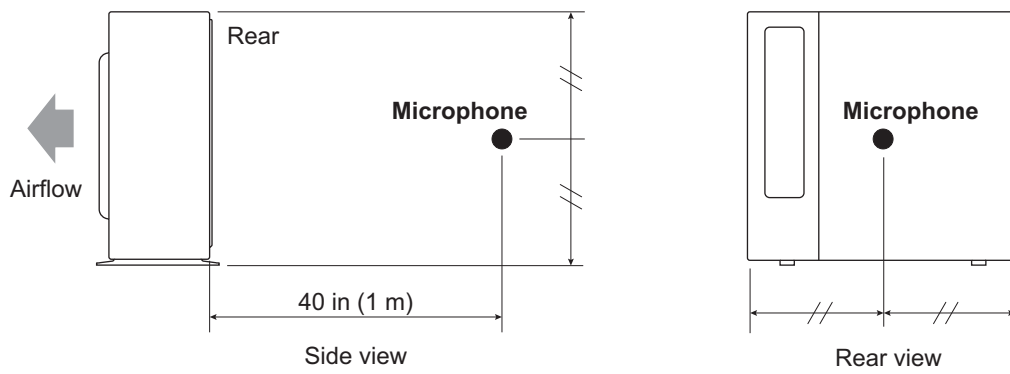

NOTE: Detailed shape of the actual outdoor unit might be slightly different from the one illustrated above.

10. Electrical characteristics

Item		Unit	Model name	
			AOU24RGLX	AOU30RGLX
Power supply	Voltage	V	208/230 V~	
	Frequency	Hz	60	
MCA *1		A	20.8	
Starting current		A	9.6	11.5
Wiring spec. *2	MAX. CKT. BKR *3		A	
	Power cable		AWG	
	Connection cable *4	Size	AWG	
		Limited wiring length	ft (m)	

Item		Unit	Model name	
			AOUG36LMAS1	AOUG48LMAS1
Power supply	Voltage	V	208/230 V~	
	Frequency	Hz	60	
MCA *1		A	39.9	
Starting current		A	20.1	
Wiring spec. *2	MAX. CKT. BKR *3		A	
	Power cable		AWG	
	Connection cable *4	Size	AWG	
		Limited wiring length	ft (m)	

*1: Minimum Circuit Ampacity (Calculation based on UL1995)

*2: Selected sample based on Japan Electrotechnical Standards and Codes Committee E0005. As the regulations of wire size and circuit breaker differ in each country or region, select appropriate devices complied to the regional standard.

*3: Maximum Circuit Breaker

*4: Limit voltage drop to less than 2%. If voltage drop is 2% or more, increase cable conductor size.

11. Safety devices

Type of protection	Protection form		Model	
			AOU24RGLX	AOU30RGLX
Circuit protection	Current fuse (Filter PCB)		250 V, 5 A × 2	
	Current fuse (Main PCB)		250 V, 3.15 A × 2	
Fan motor protection	Thermal protection	Activate	302 ⁺²⁷ ₋₁₈ °F (150 ⁺¹⁵ ₋₁₀ °C) Fan motor stop	
		Reset	248 ⁺²⁷ ₋₁₈ °F (120 ⁺¹⁵ ₋₁₀ °C) Fan motor restart	
Compressor protection	Terminal protection program (Compressor temp.)	Activate	226 °F (108 °C) Compressor stop	
		Reset	176 °F (80 °C) Compressor restart	
	Thermal protection program (Discharge temp.) (COOL or DRY mode)	Activate	230 °F (110 °C) Compressor stop	
		Reset	After 7 minutes Compressor restart	
	Thermal protection program (Outdoor temp.)	Activate	—	
		Reset	—	
High pressure protection	Pressure switch	Activate	4.2±0.1 MPa Compressor stop	
		Reset	3.2±0.15 MPa Compressor restart	

Type of protection	Protection form		Model	
			AOUG36LMAS1	AOUG48LMAS1
Fuse (Filter PCB)			AC 250 V, 5 A AC 250 V, 10 A × 2	
Protector (Filter PCB)			AC 500 V, 45 A	
Fuse (MAIN PCB)			AC 250 V, 3.15 A × 2	
Fuse (INV PCB)			AC/DC 400 V, 5 A	
Fan motor protection	Thermal protection	Activate	239±27 °F (115±15 °C) Fan motor stop	
		Reset	158 °F (70 °C) Fan motor restart	
Compressor protector	Over current protection		—	
	Temperature protection	Activate	226.4 °F (108 °C) Compressor stop	
		Reset	176 °F (80 °C) Compressor restart	
	Thermal protection program (Discharge temp.)	Activate	230 °F (110 °C) Compressor stop	
Reset		After 3 minutes and 230 °F (110 °C) less than Compressor restart		
High pressure protection		Activate	580 psi (4.0 MPa)	
		Reset	471 psi (3.25 MPa)	

12. Function settings

12-1. Setting methods

⚠ WARNING

Never touch electrical components such as the terminal blocks or reactor except the switch on the display board. It may cause a serious accident such as electric shock.

⚠ CAUTION

- Once refrigerant charging is completed, be sure to open the valve prior to performing the local settings. Otherwise, the compressor may fail.
- Discharge any static electricity from your body before touching the push switches. Never touch any terminal or pattern of any parts on the control board.

The positions of the switches on the outdoor unit control board are shown in the figure below.

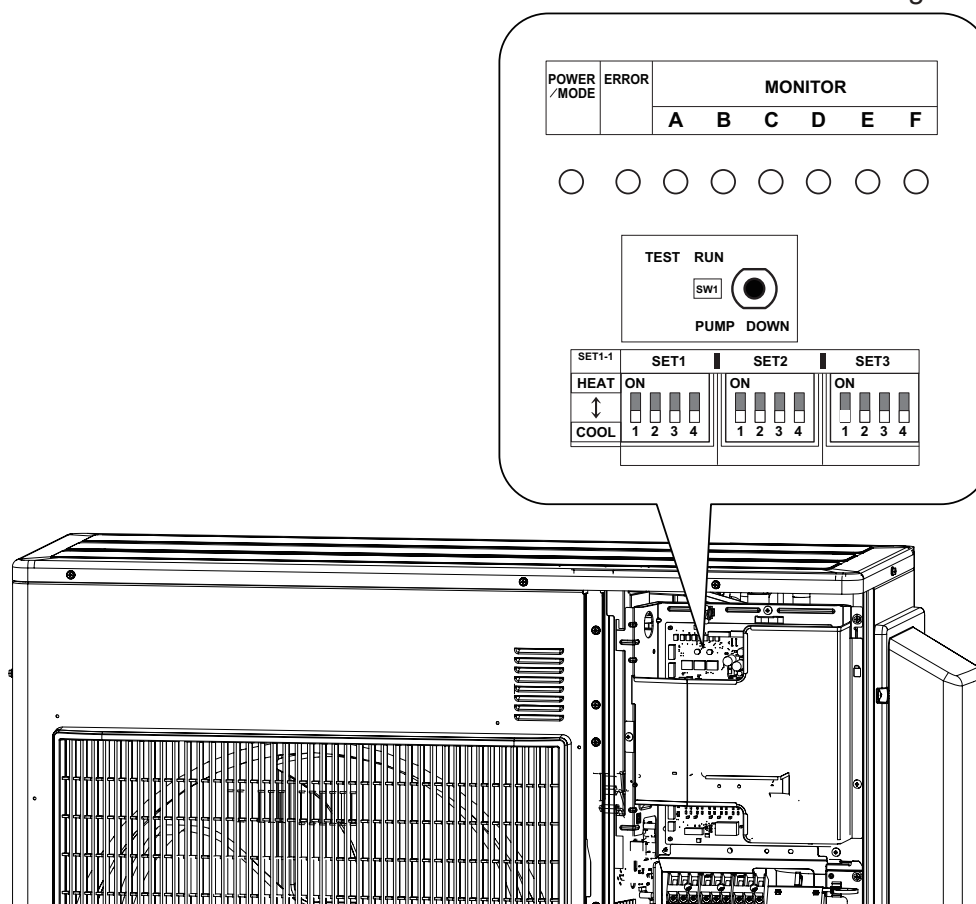

■ Setting method

1. Be sure to disconnect the power supply or turn off the breaker.
2. Change the DIP switch setting according to the required setting.
 - Various settings can be adjusted by changing DIP switches and push switches on the board of the outdoor unit.
 - The printed characters for the LED display are shown below.

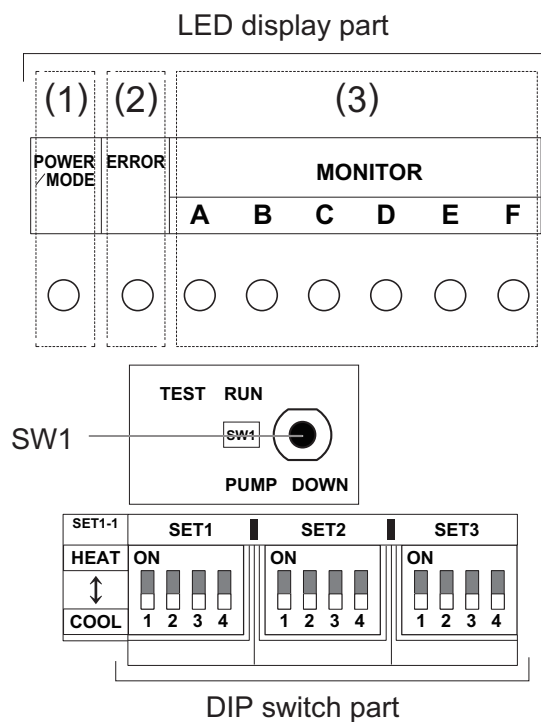

■ Description of display

LED display lamp			Function or operation method
(1)	POWER/MODE	Green	<ul style="list-style-type: none"> Turns on when the power supply is ON (Including when error occurs). Indicate the MODE by the number of flashes when the installation function is active.
(2)	ERROR	Red	Flashes at high-speed when there is an error.
(3)	MONITOR	A	<ul style="list-style-type: none"> Displays the location and contents of errors when there is an error. (Refer to Chapter 13-2. "Error code" on page 97 for details.)
		B	
		C	
		D	
		E	
		F	

Switch		Function or operation method	Factory setting
SW1	Push	<ul style="list-style-type: none"> For the test run start and stop. For the pump down start and stop. 	—
SET1-1	DIP	For selecting cooling or heating during test operation.	OFF
SET1-2	DIP	For switching SW1 operation.	OFF
SET1-3	DIP	(Prohibited)	OFF (Do not change)
SET1-4	DIP	(Prohibited)	OFF (Do not change)
SET2-1	DIP	<ul style="list-style-type: none"> For selecting outdoor unit low noise operation function. To use this function, the Central remote controller (option) is necessary. 	OFF
SET2-2	DIP	(Prohibited)	OFF (Do not change)
SET2-3	DIP	(Prohibited)	OFF (Do not change)
SET2-4	DIP	(Prohibited)	OFF (Do not change)
SET3-1	DIP	(Prohibited)	OFF (Do not change)
SET3-2	DIP	(Prohibited)	OFF (Do not change)
SET3-3	DIP	(Prohibited)	OFF (Do not change)
SET3-4	DIP	(Prohibited)	OFF (Do not change)

Be sure to disconnect the power supply or turn off the breaker before changing the DIP switch setting.

12-2. Outdoor unit low noise operation function (option)

Change the outdoor unit low noise operation by using this setting. Optional Central remote controller is necessary to use this function.

SET2-1	Setting	Factory setting
ON	Lower	
OFF	Low	◆

CAUTION

- When the low noise operation function is working, cooling and heating capacity will decrease.
- When changing the settings, explain to the customer beforehand that the capacity decreases.

13. Test

13-1. Test run

⚠ CAUTION

Always connect the power supply 12 hours prior to the start of the operation in order to protect the compressor.

1. Indoor unit
 - a. Is the drain normal?
 - b. Is there any abnormal noise and vibration during operation?
 2. Outdoor unit
 - a. Is there any abnormal noise and vibration during operation?
 - b. Will noise, wind, or drain water from the unit disturb the neighbors?
 - c. Is there any gas leakage?
- Do not operate the air conditioner in the test running state for a long time.
 - For the operation method of the test run for indoor unit and central remote controller, refer to the operating manual and perform operation check.

■ Test run method

Be sure to temporarily disconnect the power supply or turn off the breaker before changing the DIP switch settings.

1. Check the 3-way valves (both at the liquid side and gas side) are opened. Confirm that the DIP switch SET1-2 is switched off.
2. Set the operation mode to "COOL" or "HEAT". When switching the DIP switch SET1-1 between HEAT and COOL, disconnect the power supply or turn off the circuit breaker beforehand.

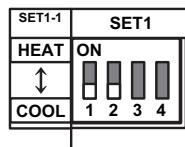

- In the first test run, be sure to set the operation mode to "COOL".
 - The operation mode cannot be switched between "COOL" and "HEAT" during the test run. To switch the operation mode between "COOL" and "HEAT", stop the test run, switch the operation mode, and then start the test run again.
3. Press "TEST RUN" switch for more than 3 seconds.
The POWER / MODE LED flashes once.

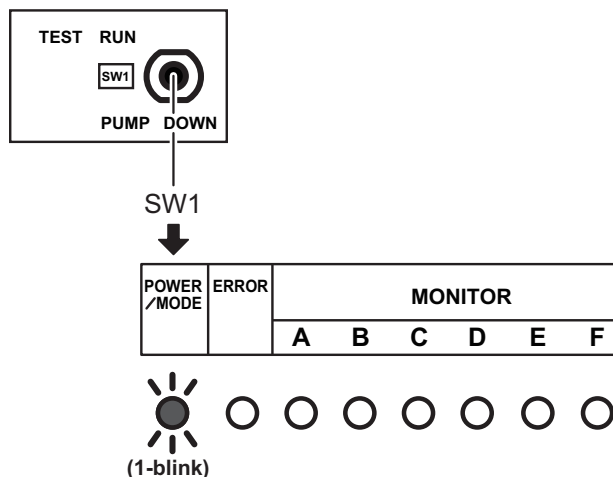

4. Confirm operating status.
5. Press "TEST RUN" switch for more than 3 seconds.

POWER /MODE	ERROR	MONITOR					
		A	B	C	D	E	F



POWER/MODE LED will turn on, and test run stops.

13-2. Error code

If an error occurs, the LED will light up to display the error location and the error code.

■ In the event of an error

The error LED blink quickly.

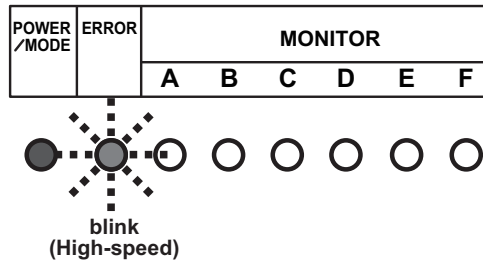

■ Error location display

LEDs A to F of MONITOR light up and display the error location. In the case of an overall error, LEDs A to F of MONITOR do not light up.

Example: Coil error in indoor unit B

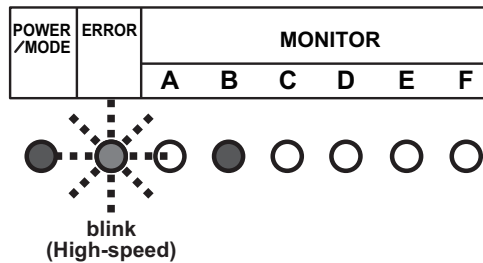

■ Error code display

While the error is occurring, briefly press SW1. The error code is displayed.

Example: Coil error (Error cord = 9A.1)

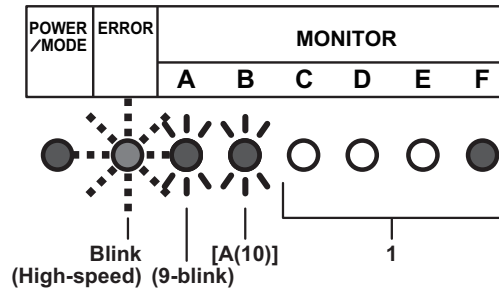

Display mode

LED on: ●

LED off: ○

Blink: 
(0.5s Light on / 0.5s Light off)

Number of blinking: ()

For MONITOR (A and B)

- A: 10-Blink
- C: 11-Blink
- F: 12-Blink
- J: 13-Blink
- P: 14-Blink
- U: 15-Blink

	C	D	E	F	
	○	○	○	●	→ 1
	○	○	●	○	→ 2
	○	○	●	●	→ 3
	○	●	○	○	→ 4
	○	●	○	●	→ 5
	○	●	●	○	→ 6
	○	●	●	●	→ 7
	●	○	○	○	→ 8
	●	○	○	●	→ 9
	●	○	●	○	→ A
	●	○	●	●	→ C
	●	●	○	○	→ F
	●	●	○	●	→ J
	●	●	●	○	→ P
	●	●	●	●	→ U

OUTDOOR UNIT
AOU24-30RGLX,
AOUG36-48LMAS1

OUTDOOR UNIT
AOU24-30RGLX,
AOUG36-48LMAS1

Error code	Error type
11.3	Serial communication error
11.4	Serial communication error during operation
16.5	Communication error between controller and outdoor unit
22.1	Indoor unit capacity error
5U.1	Indoor unit error
62.1	Outdoor unit PCB Model information error
62.3	EEPROM access error
62.8	EEPROM data corruption error
63.1	Inverter error
65.3	IPM error (Trip terminal L error)
71.1	Discharge temp. sensor error
72.1	Compressor temp. sensor error
73.2	Heat exchanger middle temp. sensor error
73.3	Heat exchanger liquid temp. sensor error
74.1	Outdoor temp. sensor error
75.1	Suction gas temp. sensor error
76.1	Valve sensor error
76.2	
77.1	Heat sink temp. sensor error
84.1	Current sensor 1 error (stoppage permanently)
86.1	Discharge pressure sensor error
86.4	Outdoor unit high pressure switch1 error
94.1	Trip detection
95.1	Compressor motor control error (stoppage permanently)
97.3	Fan motor 1 error (Duty error)
98.3	Fan motor 2 error (Duty error)
99.1	4-way valve error
9A.1	Coil 1 (expansion valve 1) error
A1.1	Discharge temperature 1 error (stoppage permanently)
A3.1	Compressor 1 temperature error

13-3. Pump down

⚠ WARNING

During the pump down operation, make sure that compressor is off before you remove the refrigerant piping. Do not remove the connection pipe while the compressor is in operation with valve open. This may cause abnormal pressure in the refrigeration cycle that leads to breakage and even injury.

■ Pump down operation

When moving or discarding the air conditioner, in order to consider the environment and avoid the discharge of refrigerant to the atmosphere, pump down according to the following procedure.

1. Connect the pressure gauge to the charging port.
2. Change the DIP switch on the board (SET1-2) to On*1
*Be sure the power supply is disconnected on the breaker is turned off when changing the DIP switch.

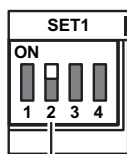

*1: DIP switch (SET1-2)

3. To start operation, press the [PUMP DOWN] switch*2 for 3 seconds or press after the power has been on for 3 min.

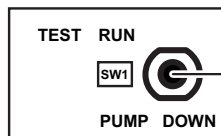

*2: Push switch (SW1)

During pump down, the LED (POWER/MODE) will flash 3 times consecutively.

POWER/MODE	ERROR	MONITOR					
		A	B	C	D	E	F



(3-blink)

NOTE: If the [PUMP DOWN] switch is pressed during compressor operation, the compressor will stop, and the operation will start after about 3 min.

4. Close the liquid pipe valve.
5. When the value between 7.3 psi and 0 psi (0.05 Mpa to 0 Mpa) is shown, close the gas pipe valve.
6. Stop pump down by pressing the [PUMP DOWN] switch for 3 seconds.
The LED will light as follows.

POWER/MODE	ERROR	MONITOR					
		A	B	C	D	E	F



(3-blink)

7. Disconnect the power supply or turn off the breaker.

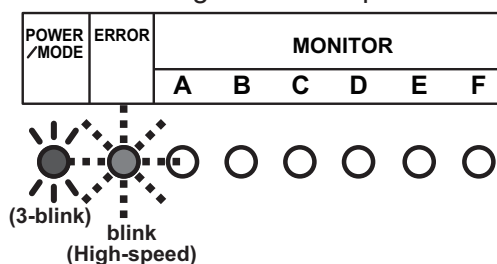

NOTE: If the pump down is not stopped by pressing the switch as in step 6, it will stop automatically after 15 minutes and the LED will light as follows. If the pump down is complete, disconnect the power supply or turn off the breaker. If not completed open the liquid pipe valve, and then start again from step 3.





- In order to interrupt the pump down operation, press the [PUMP DOWN] switch again. The LED will return to the original display before starting pump down. (POWER/MODE LED: On)
- The pump down may stop before completion due to error. To complete the pump down, correct the error, open the liquid pipe valve and then start from step 1 again. Otherwise, the refrigerant can be recovered from the service port.

14. Accessories

14-1. Models: AOU24RGLX and AOU30RGLX

Part name	Exterior	Q'ty	Part name	Exterior	Q'ty
Installation manual		1	Drain cap		5
Drain pipe		1			

14-2. Models: AOUG36LMAS1 and AOUG48LMAS1

Part name	Exterior	Q'ty	Part name	Exterior	Q'ty
Installation manual		1	Drain cap		7
Drain pipe		1			