

AIR CONDITIONER

**Wall mounted type**

## DESIGN & TECHNICAL MANUAL

---

---

INDOOR



ASUH18LMAS



ASUH24LMAS

---

OUTDOOR



AOUH18LMAS1  
AOUH24LMAS1

---

**FUJITSU GENERAL LIMITED**

**Notices:**

- Product specifications and design are subject to change without notice for future improvement.
- For further details, please check with our authorized dealer.

**Trademarks**

FGLair™ is trademark of Fujitsu General Limited in the United States, other countries or both.

Google Play™ is trademark of Google Inc.

App Store® is a service mark of Apple Inc., registered in the U.S. and other countries.

# CONTENTS

---

<b>Part 1. INDOOR UNIT</b> .....	<b>1</b>
<b>1. Specifications</b> .....	<b>2</b>
<b>2. Dimensions</b> .....	<b>4</b>
2-1. Model: ASUH18LMAS .....	4
2-2. Model: ASUH24LMAS .....	6
<b>3. Wiring diagrams</b> .....	<b>8</b>
3-1. Models: ASUH18LMAS and ASUH24LMAS .....	8
<b>4. Capacity table</b> .....	<b>9</b>
4-1. Cooling capacity.....	9
4-2. Heating capacity .....	11
<b>5. Fan performance</b> .....	<b>12</b>
5-1. Air velocity distributions.....	12
5-2. Airflow .....	14
<b>6. Operation noise (sound pressure)</b> .....	<b>16</b>
6-1. Noise level curve.....	16
6-2. Sound level check point .....	17
<b>7. Safety devices</b> .....	<b>18</b>
<b>8. External input and output</b> .....	<b>19</b>
8-1. External input.....	20
8-2. External output.....	22
8-3. Combination of external input and output.....	24
8-4. Details of function .....	26
<b>9. Group connection</b> .....	<b>49</b>
<b>10. Remote controller</b> .....	<b>50</b>
10-1. Wireless remote controller .....	50
<b>11. Function settings</b> .....	<b>52</b>
11-1. Function settings by using remote controller.....	52
11-2. Custom code setting for wireless remote controller.....	62
11-3. Switching the temperature unit of remote controller .....	63
<b>12. Accessories</b> .....	<b>64</b>
12-1. Model: ASUH18LMAS .....	64
12-2. Model: ASUH24LMAS .....	65
<b>13. Optional parts</b> .....	<b>66</b>
13-1. Controllers .....	66
13-2. Others .....	67

## CONTENTS (continued)

---

<b>Part 2. OUTDOOR UNIT</b> .....	<b>69</b>
<b>1. Specifications</b> .....	<b>70</b>
<b>2. Dimensions</b> .....	<b>71</b>
2-1. Models: AOUH18LMAS1 and AOUH24LMAS1 .....	71
<b>3. Installation space</b> .....	<b>72</b>
3-1. Models: AOUH18LMAS1 and AOUH24LMAS1 .....	72
<b>4. Refrigerant circuit</b> .....	<b>76</b>
4-1. Models: AOUH18LMAS1 and AOUH24LMAS1 .....	76
<b>5. Wiring diagrams</b> .....	<b>77</b>
5-1. Models: AOUH18LMAS1 and AOUH24LMAS1 .....	77
<b>6. Capacity compensation rate for pipe length and height difference</b> .....	<b>78</b>
6-1. Models: AOUH18LMAS1 and AOUH24LMAS1 .....	78
<b>7. Additional charge calculation</b> .....	<b>79</b>
7-1. Model: AOUH18LMAS1 .....	79
7-2. Model: AOUH24LMAS1 .....	79
<b>8. Airflow</b> .....	<b>80</b>
8-1. Model: AOUH18LMAS1 .....	80
8-2. Model: AOUH24LMAS1 .....	80
<b>9. Operation noise (sound pressure)</b> .....	<b>81</b>
9-1. Noise level curve.....	81
9-2. Sound level check point .....	82
<b>10. Electrical characteristics</b> .....	<b>83</b>
<b>11. Safety devices</b> .....	<b>84</b>
<b>12. External input and output</b> .....	<b>85</b>
12-1.External input .....	85
12-2.External output.....	87
<b>13. Function settings</b> .....	<b>89</b>
13-1.Control PCB and switch buttons location .....	89
13-2.Local setting procedure.....	91
<b>14. Accessories</b> .....	<b>93</b>
14-1.Models: AOUH18LMAS1 and AOUH24LMAS1 .....	93
<b>15. Optional parts</b> .....	<b>94</b>

# **Part 1. INDOOR UNIT**

---

**WALL MOUNTED TYPE:**

**ASUH18LMAS**

**ASUH24LMAS**

## 1. Specifications

Type				Wall mounted				
				Inverter heat pump				
Model name				ASUH18LMAS	ASUH24LMAS			
Power supply				208/230 V ~ 60 Hz				
Power supply intake				Outdoor unit				
Available voltage range				187—253 V				
Capacity	Cooling	Rated	kW	5.28	6.45			
			Btu/h	18,000	22,000			
		Min.—Max.	kW	2.05—5.86	2.67—8.00			
			Btu/h	7,000—20,000	9,100—27,300			
	Heating	Rated	kW	6.33	7.39			
			Btu/h	21,600	25,200			
		Min.—Max.	kW	2.34—8.50	2.40—10.84			
			Btu/h	8,000—29,000	8,200—37,000			
	Heating (17°F) <sup>1</sup>	Rated	kW	3.99	4.60			
			Btu/h	13,600	15,700			
Max.		kW	6.95	8.41				
		Btu/h	23,700	28,700				
Input power	Cooling	Rated	kW	1.38	1.76			
				Min.—Max.	0.45—1.86	0.43—2.63		
		Heating	Rated	1.58	1.87			
				Min.—Max.	0.55—2.82	0.52—3.53		
	Heating (17°F) <sup>1</sup>	Rated	kW	1.28	1.51			
				Max.	0.41—3.06	0.39—3.60		
		Cooling	Rated	A	6.2	7.8		
					Heating	7.0	8.3	
EER	Cooling		kW/kW	3.80	3.66			
			Btu/hW	13.0	12.5			
COP	Heating		kW/kW	4.00	3.95			
			Btu/hW	13.6	13.5			
SEER	Cooling		Btu/hW	21.1	22.5			
HSPF	Heating		Btu/hW	12.5	12.0			
Power factor	Cooling		%	96.8	98.1			
	Heating		%	98.1	98.0			
Moisture removal			pints/h (L/h)	4.0 (1.9)	6.3 (3.0)			
Maximum operating current <sup>2</sup>			Cooling	13.4	15.4			
			Heating	13.9	15.9			
Fan	Airflow rate	Cooling	HIGH	577 (980)	647 (1,100)			
			MED	489 (830)	530 (900)			
			LOW	377 (640)	436 (740)			
			QUIET	300 (510)	371 (630)			
		Heating	HIGH	589 (1,000)	730 (1,240)			
			MED	500 (850)	530 (900)			
			LOW	377 (640)	436 (740)			
			QUIET	300 (510)	371 (630)			
	Type × Q'ty	Crossflow fan × 1						
	Motor output			W	59	78		
Sound pressure level <sup>3</sup>	Cooling		HIGH	46	46			
			MED	41	42			
			LOW	35	37			
			QUIET	30	33			
	Heating		HIGH	46	48			
			MED	41	38			
			LOW	35	34			
			QUIET	30	30			
			Dimensions (H × W × D)			in (mm)	Main 1: 8-1/4 × 31-5/16 × 1-1/16 (210 × 796 × 26.6) Main 2: 4-15/16 × 31-5/16 × 1-1/16 (126 × 796 × 26.6) Sub 1: 3-5/16 × 31-5/16 × 1/2 (84 × 796 × 13.3)	18-3/16 × 35-6/16 × 1-1/16 (462 × 898 × 26.6)
			Fin pitch			FPI (mm)	Main 1: 21 (1.2) Main 2: 21 (1.2) Sub 1: 18 (1.4)	21 (1.2)
Rows × Stages				Main 1: 2 × 10 Main 2: 2 × 6 Sub 1: 1 × 4	2 × 22			
Pipe type				Copper				
Fin type				Aluminum				
Material				Polystyrene				
Color				White Approximate color of Munsell N 9.25/				
Dimensions (H × W × D)	Net	in (mm)	11 × 38-9/16 × 9-7/16 (280 × 980 × 240)		13-6/16 × 45-4/16 × 11 (340 × 1,150 × 280)			
	Gross		12-11/16 × 42-7/16 × 13-5/8 (322 × 1,078 × 346)		15-15/16 × 50 × 17-11/16 (405 × 1,270 × 450)			
Weight	Net	lb (kg)	29 (13.0)		36 (16.5)			
	Gross		36 (16.5)		49 (22.0)			
Connection pipe	Size	Liquid	Ø3/8 (Ø9.52)					
		Gas	Ø5/8 (Ø15.88)					
	Method	Flare						
Drain hose	Material			PP+HDPE				
	Tip diameter			in (mm) Ø17/32 (Ø13.8) (I.D.), Ø19/32 to 21/32 (Ø15.0 to 16.8) (O.D.)				
Operation range	Cooling		°F (°C)	64 to 90 (18 to 32)				
			%RH	80 or less				
	Heating		°F (°C)	86 (30) or less				
			Remote controller type					
					Wireless (Wired, Mobile app <sup>4</sup> [FGLair™] [option])			

Type	Wall mounted	
	Inverter heat pump	
Model name	ASUH18LMAS	ASUH24LMAS
<p><b>NOTES:</b></p> <ul style="list-style-type: none"> <li>• Specifications are based on the following conditions: <ul style="list-style-type: none"> <li>– Cooling: Indoor temperature of 80°FDB (26.67°CDB) /67°FWB (19.44°CWB), and outdoor temperature of 95°FDB (35°CDB) / 75°FWB (23.9°CWB).</li> <li>– Heating: Indoor temperature of 70°FDB (21.11°CDB) /59°FWB (15.56°CWB), and outdoor temperature of 47°FDB (8.33°CDB) /43°FWB (6.11°CWB).</li> <li>– *1: Heating (17°F): Indoor temperature of 70°FDB (21.11°CDB) /60°FWB (15.56°CWB), and outdoor temperature of 17°FDB (-8.33°CDB) /15°FWB (-9.44°CWB).</li> <li>– Pipe length: 25 ft (7.5 m), Height difference: 0 ft (0 m). (Between outdoor unit and indoor unit.)</li> </ul> </li> <li>• Protective function might work when using it outside the operation range.</li> <li>• *2: Maximum current is maximum value when operated within the operation range.</li> <li>• *3: Sound pressure level: <ul style="list-style-type: none"> <li>– Measured values in manufacturer's anechoic chamber.</li> <li>– Because of the surrounding sound environment, the sound levels measured in actual installation conditions might be higher than the specified values here.</li> </ul> </li> <li>• *4: Available on Google Play™ store or on App Store®. Optional WLAN adapter is also required. For details, refer to the setting manual.</li> </ul>		

## 2. Dimensions

### 2-1. Model: ASUH18LMAS

Unit: in (mm)

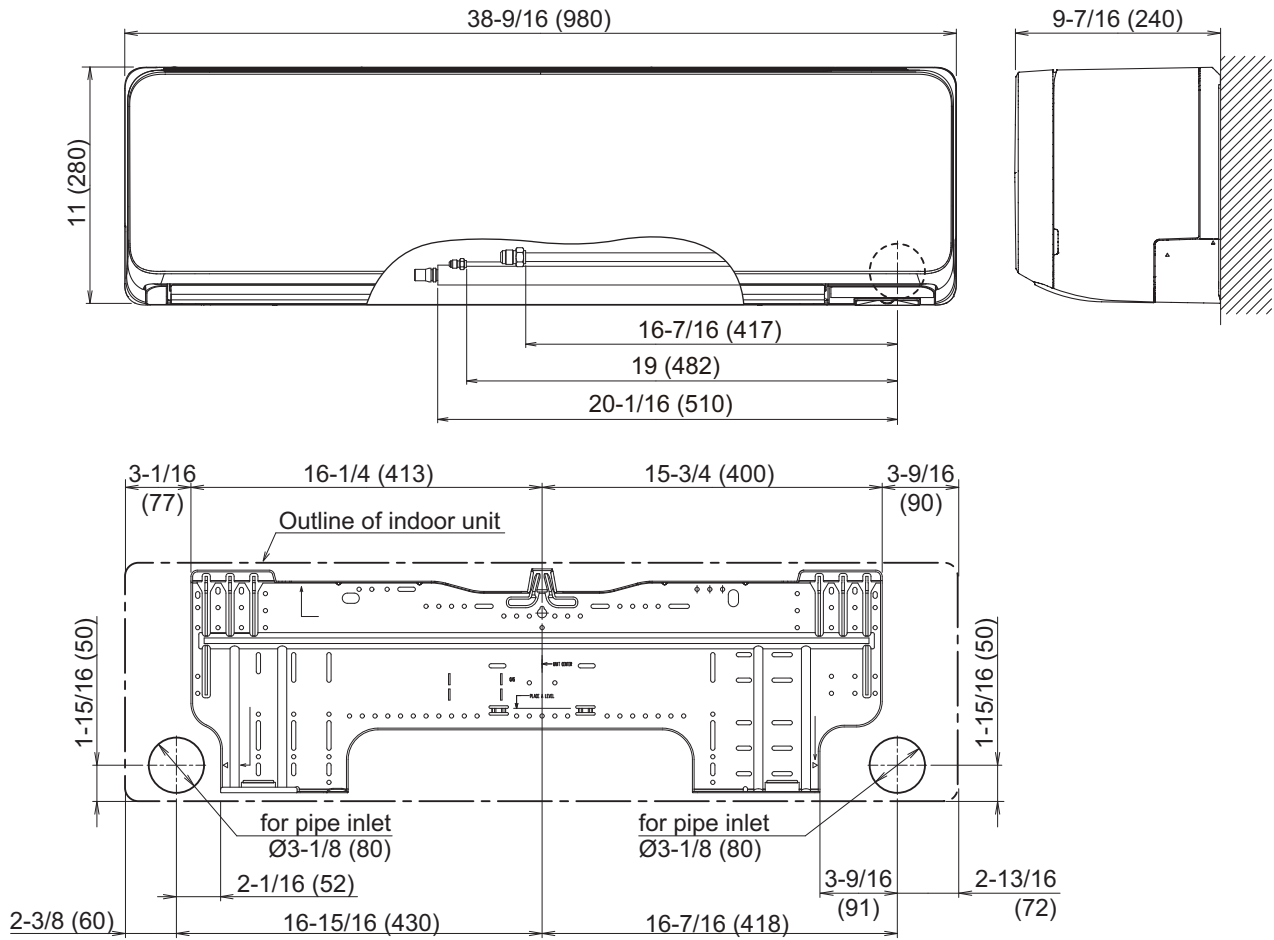



## Installation space requirement

Provide sufficient installation space for product safety.

### ⚠ CAUTION

Do not place any other electrical products or household belongings under the product. Condensation dripping from the product might get them wet, and may cause damage or malfunction to the property.

Unit: in (mm)

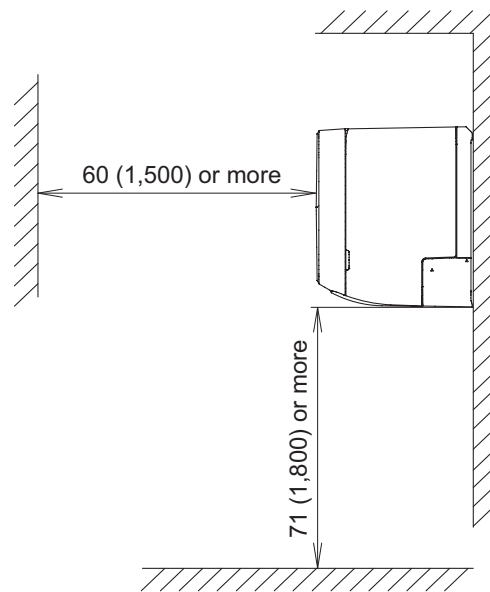
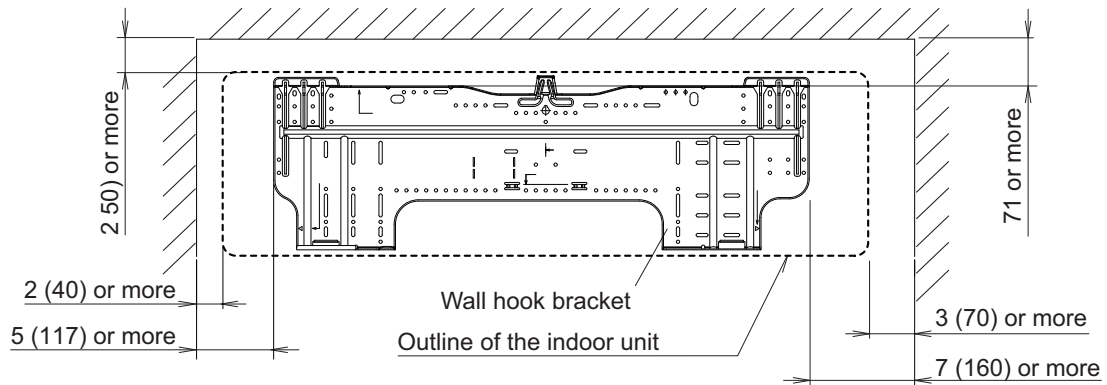

## 2-2. Model: ASUH24LMAS

Unit: in (mm)

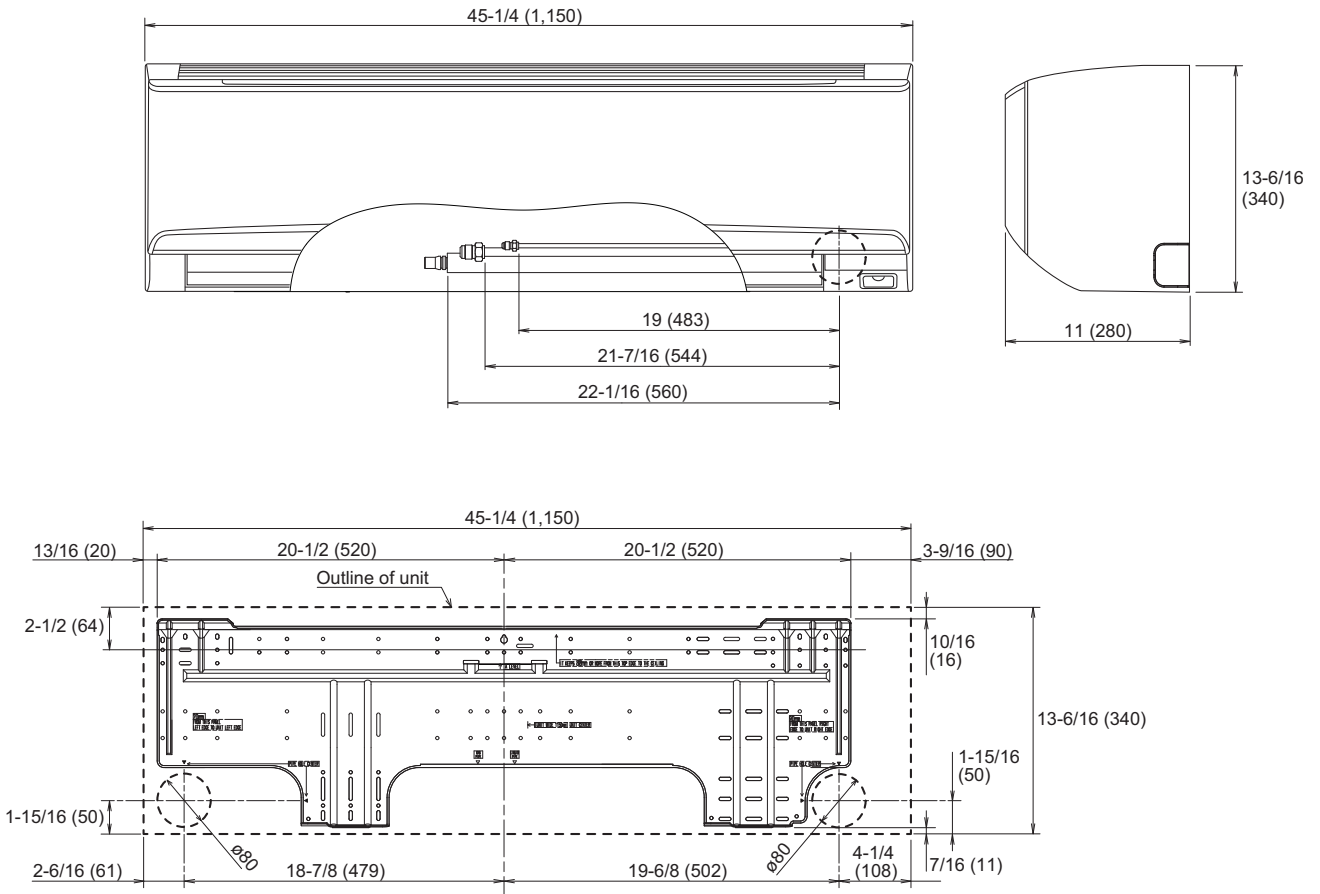

## ■ Installation space requirement

Provide sufficient installation space for product safety.

### ⚠ CAUTION

Do not place any other electrical products or household belongings under the product. Condensation dripping from the product might get them wet, and may cause damage or malfunction to the property.

Unit: in (mm)

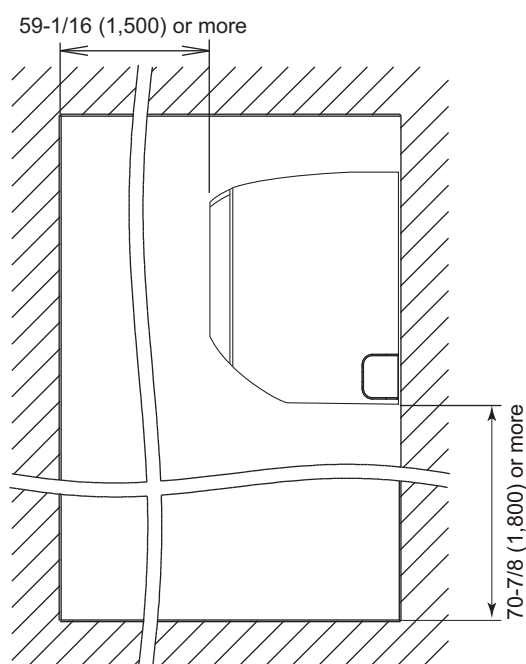
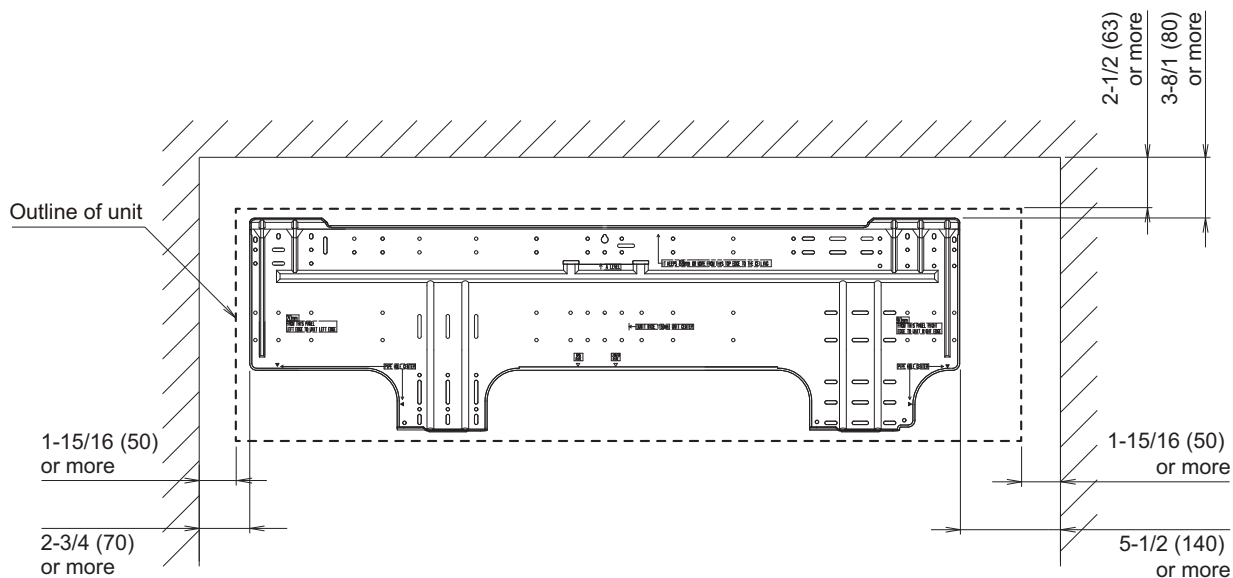

### 3. Wiring diagrams

#### 3-1. Models: ASUH18LMAS and ASUH24LMAS

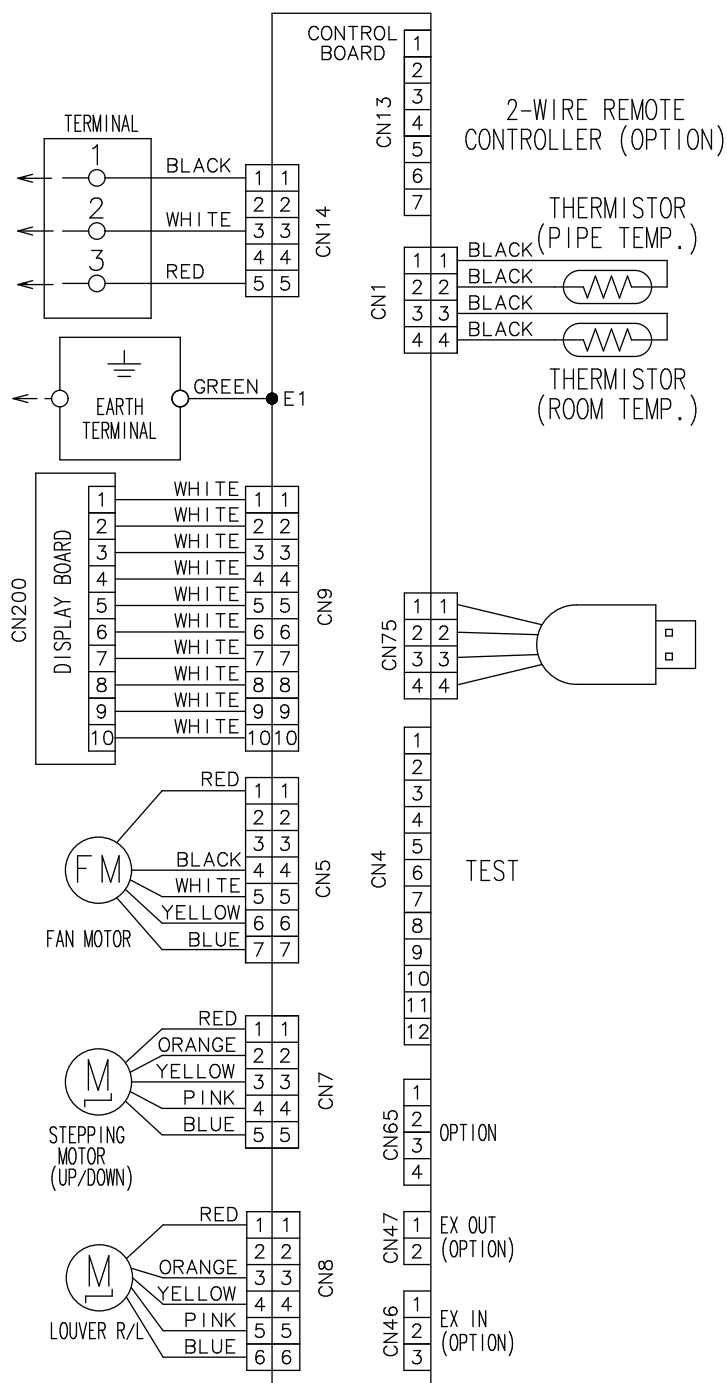

## 4. Capacity table

Capacity tables show each of following values calculated based on the outdoor temperature and the indoor temperature, under given Airflow Rate (AFR):

**For cooling capacity:** Total Capacity (TC), Sensible Heat Capacity (SHC), and Input Power (IP)

**For heating capacity:** Total Capacity (TC) and Input Power (IP)

### 4-1. Cooling capacity

#### ■ Model: ASUH18LMAS

AFR	CFM	577
-----	-----	-----

		Indoor temperature																	
		64			70			75			80			85			90		
		54			60			63			67			71			73		
Outdoor temperature	°FDB	TC	SHC	IP	TC	SHC	IP	TC	SHC	IP	TC	SHC	IP	TC	SHC	IP	TC	SHC	IP
	°FDB	kBTu		kW	kBTu		kW	kBTu		kW	kBTu		kW	kBTu		kW	kBTu		kW
	14	16.53	11.31	0.38	18.09	12.37	0.39	19.83	13.56	0.39	20.44	13.98	0.40	21.78	14.89	0.40	23.22	15.88	0.40
	23	15.68	10.94	0.49	17.16	11.97	0.50	18.80	13.12	0.51	19.38	13.52	0.52	20.65	14.41	0.52	22.02	15.36	0.53
	32	15.03	10.69	0.62	16.45	11.70	0.63	18.02	12.82	0.64	18.58	13.21	0.65	19.80	14.08	0.65	21.11	15.01	0.66
	41	14.05	9.60	0.73	15.38	10.51	0.74	16.85	11.52	0.76	17.37	11.87	0.76	18.51	12.65	0.77	19.73	13.49	0.78
	50	13.90	9.74	0.81	15.21	10.65	0.82	16.67	11.68	0.84	17.18	12.04	0.85	18.31	12.82	0.86	19.52	13.67	0.86
	59	14.03	9.79	0.90	15.35	10.71	0.90	16.82	11.74	0.92	17.34	12.10	0.93	18.47	12.89	0.94	19.70	13.75	0.95
	67	17.04	12.04	0.93	18.65	13.17	0.94	20.44	14.43	0.96	21.07	14.88	0.97	22.45	15.85	0.98	23.93	16.90	0.99
	77	16.27	11.69	1.07	17.80	12.79	1.08	19.51	14.02	1.10	20.11	14.45	1.11	21.43	15.40	1.13	22.84	16.41	1.14
	87	15.47	11.33	1.21	16.92	12.40	1.22	18.55	13.59	1.24	19.12	14.01	1.26	20.37	14.93	1.27	21.72	15.91	1.28
95	14.56	10.92	1.32	15.93	11.95	1.34	17.46	13.10	1.37	18.00	13.50	1.38	19.18	14.39	1.39	20.45	15.34	1.41	
104	13.87	10.63	1.47	15.17	11.63	1.49	16.63	12.75	1.52	17.14	13.14	1.53	18.27	14.00	1.55	19.47	14.93	1.56	
115	12.65	10.13	1.65	13.85	11.08	1.67	15.17	12.14	1.70	15.64	12.52	1.72	16.67	13.34	1.73	17.77	14.22	1.75	

AFR	m <sup>3</sup> /h	980
-----	-------------------	-----

		Indoor temperature																	
		17.8			21.1			23.9			26.7			29.4			32.2		
		12.2			15.6			17.2			19.4			21.7			22.8		
Outdoor temperature	°CDB	TC	SHC	IP	TC	SHC	IP	TC	SHC	IP	TC	SHC	IP	TC	SHC	IP	TC	SHC	IP
	°CDB	kW		kW	kW		kW	kW		kW	kW		kW	kW		kW	kW		kW
	-10.0	4.85	3.31	0.38	5.30	3.63	0.39	5.81	3.97	0.39	5.99	4.10	0.40	6.38	4.36	0.40	6.80	4.65	0.40
	-5.0	4.60	3.21	0.49	5.03	3.51	0.50	5.51	3.84	0.51	5.68	3.96	0.52	6.05	4.22	0.52	6.45	4.50	0.53
	0.0	4.41	3.13	0.62	4.82	3.43	0.63	5.28	3.76	0.64	5.45	3.87	0.65	5.80	4.13	0.65	6.19	4.40	0.66
	5.0	4.12	2.81	0.73	4.51	3.08	0.74	4.94	3.38	0.76	5.09	3.48	0.76	5.42	3.71	0.77	5.78	3.95	0.78
	10.0	4.07	2.85	0.81	4.46	3.12	0.82	4.88	3.42	0.84	5.04	3.53	0.85	5.37	3.76	0.86	5.72	4.01	0.86
	15.0	4.11	2.87	0.90	4.50	3.14	0.90	4.93	3.44	0.92	5.08	3.55	0.93	5.41	3.78	0.94	5.77	4.03	0.95
	19.4	4.99	3.53	0.93	5.47	3.86	0.94	5.99	4.23	0.96	6.17	4.36	0.97	6.58	4.65	0.98	7.01	4.95	0.99
	25.0	4.77	3.43	1.07	5.22	3.75	1.08	5.72	4.11	1.10	5.89	4.23	1.11	6.28	4.51	1.13	6.69	4.81	1.14
	30.6	4.53	3.32	1.21	4.96	3.63	1.22	5.44	3.98	1.24	5.60	4.11	1.26	5.97	4.38	1.27	6.37	4.66	1.28
35.0	4.27	3.20	1.32	4.67	3.50	1.34	5.12	3.84	1.37	5.28	3.96	1.38	5.62	4.22	1.39	5.99	4.49	1.41	
40.0	4.06	3.12	1.47	4.45	3.41	1.49	4.87	3.74	1.52	5.02	3.85	1.53	5.35	4.10	1.55	5.71	4.38	1.56	
46.1	3.71	2.97	1.65	4.06	3.25	1.67	4.45	3.56	1.70	4.58	3.67	1.72	4.89	3.91	1.73	5.21	4.17	1.75	

# Model: ASUH24LMAS

AFR	CFM	647
-----	-----	-----

		Indoor temperature																	
		64			70			75			80			85			90		
		54			60			63			67			71			73		
Outdoor temperature	°FDB	TC	SHC	IP	TC	SHC	IP	TC	SHC	IP	TC	SHC	IP	TC	SHC	IP	TC	SHC	IP
	°FWB	kBTu			kBTu			kBTu			kBTu			kBTu			kBTu		
		kW			kW			kW			kW			kW			kW		
	14	19.67	10.96	0.94	21.52	12.00	0.95	23.58	13.15	0.97	24.31	13.55	0.98	25.91	14.44	0.99	27.62	15.39	1.00
	23	17.85	10.16	1.25	19.54	11.12	1.26	21.41	12.18	1.29	22.07	12.56	1.30	23.52	13.38	1.32	25.07	14.27	1.33
	32	16.94	9.82	1.39	18.54	10.75	1.40	20.32	11.78	1.43	20.94	12.14	1.44	22.32	12.94	1.46	23.79	13.80	1.47
	41	18.12	10.09	1.31	19.83	11.04	1.33	21.73	12.10	1.36	22.40	12.48	1.37	23.87	13.29	1.38	25.44	14.17	1.40
	50	19.13	10.93	1.24	20.93	11.96	1.25	22.94	13.11	1.28	23.64	13.51	1.29	25.20	14.40	1.31	26.86	15.35	1.32
	59	20.18	11.48	1.10	22.08	12.56	1.11	24.20	13.76	1.13	24.94	14.19	1.14	26.58	15.12	1.15	28.34	16.11	1.17
	67	20.40	11.79	1.05	22.32	12.90	1.07	24.46	14.14	1.09	25.22	14.58	1.10	26.87	15.53	1.11	28.65	16.56	1.12
77	19.79	11.11	1.36	21.66	12.16	1.38	23.73	13.33	1.41	24.46	13.74	1.42	26.07	14.64	1.43	27.79	15.61	1.45	
87	18.85	10.78	1.52	20.63	11.80	1.53	22.60	12.93	1.56	23.30	13.33	1.58	24.83	14.20	1.60	26.47	15.14	1.61	
95	17.80	10.42	1.69	19.47	11.40	1.71	21.34	12.49	1.74	22.00	12.88	1.76	23.44	13.72	1.78	24.99	14.63	1.80	
104	16.64	10.06	1.85	18.21	11.01	1.87	19.95	12.07	1.91	20.57	12.44	1.93	21.92	13.25	1.95	23.37	14.13	1.97	
115	12.66	8.85	1.55	13.85	9.68	1.56	15.18	10.61	1.59	15.65	10.93	1.61	16.68	11.65	1.63	17.78	12.42	1.64	

AFR	m³/h	1,100
-----	------	-------

		Indoor temperature																	
		17.8			21.1			23.9			26.7			29.4			32.2		
		12.2			15.6			17.2			19.4			21.7			22.8		
Outdoor temperature	°CDB	TC	SHC	IP	TC	SHC	IP	TC	SHC	IP	TC	SHC	IP	TC	SHC	IP	TC	SHC	IP
	°CWB	kW			kW			kW			kW			kW			kW		
	-10.0	5.76	3.21	0.94	6.31	3.52	0.95	6.91	3.85	0.97	7.13	3.97	0.98	7.59	4.23	0.99	8.09	4.51	1.00
	-5.0	5.23	2.98	1.25	5.73	3.26	1.26	6.27	3.57	1.29	6.47	3.68	1.30	6.89	3.92	1.32	7.35	4.18	1.33
	0.0	4.97	2.88	1.39	5.43	3.15	1.40	5.95	3.45	1.43	6.14	3.56	1.44	6.54	3.79	1.46	6.97	4.04	1.47
	5.0	5.31	2.96	1.31	5.81	3.24	1.33	6.37	3.55	1.36	6.56	3.66	1.37	6.99	3.90	1.38	7.46	4.15	1.40
	10.0	5.61	3.20	1.24	6.13	3.50	1.25	6.72	3.84	1.28	6.93	3.96	1.29	7.38	4.22	1.31	7.87	4.50	1.32
	15.0	5.91	3.36	1.10	6.47	3.68	1.11	7.09	4.03	1.13	7.31	4.16	1.14	7.79	4.43	1.15	8.30	4.72	1.17
	19.4	5.98	3.46	1.05	6.54	3.78	1.07	7.17	4.14	1.09	7.39	4.27	1.10	7.88	4.55	1.11	8.40	4.85	1.12
	25.0	5.80	3.26	1.36	6.35	3.56	1.38	6.96	3.91	1.41	7.17	4.03	1.42	7.64	4.29	1.43	8.15	4.57	1.45
30.6	5.52	3.16	1.52	6.05	3.46	1.53	6.63	3.79	1.56	6.83	3.91	1.58	7.28	4.16	1.60	7.76	4.44	1.61	
35.0	5.22	3.05	1.69	5.71	3.34	1.71	6.26	3.66	1.74	6.45	3.77	1.76	6.87	4.02	1.78	7.32	4.29	1.80	
40.0	4.88	2.95	1.85	5.34	3.23	1.87	5.85	3.54	1.91	6.03	3.65	1.93	6.42	3.88	1.95	6.85	4.14	1.97	
46.1	3.71	2.59	1.55	4.06	2.84	1.56	4.45	3.11	1.59	4.59	3.20	1.61	4.89	3.42	1.63	5.21	3.64	1.64	

## 4-2. Heating capacity

NOTE: Values mentioned in the table are calculated based on the maximum capacity.

### Model: ASUH18LMAS

AFR	CFM	589
-----	-----	-----

Outdoor temperature		Indoor temperature											
		°FDB	°FDB	60		65		70		72		75	
				TC kBtu	IP kW	TC kBtu	IP kW	TC kBtu	IP kW	TC kBtu	IP kW	TC kBtu	IP kW
5	3	22.79	3.02	22.20	3.08	21.60	3.15	21.00	3.21	20.41	3.27		
14	12	24.47	2.96	23.83	3.01	23.19	3.08	22.55	3.14	21.91	3.20		
23	19	26.14	2.89	25.46	2.94	24.77	3.01	24.09	3.07	23.40	3.12		
32	28	27.81	2.82	27.09	2.87	26.36	2.94	25.63	2.99	24.90	3.05		
41	37	29.49	2.75	28.71	2.81	27.94	2.87	27.17	2.92	26.40	2.97		
47	43	30.60	2.71	29.80	2.76	29.00	2.82	28.20	2.87	27.40	2.93		
50	47	31.14	2.69	30.33	2.74	29.51	2.80	24.87	2.85	24.87	2.91		
59	50	29.38	2.34	28.61	2.38	27.84	2.43	24.87	2.48	24.87	2.53		
68	59	27.61	2.06	26.89	2.10	26.17	2.14	24.87	2.18	24.72	2.23		
75	64	26.24	1.82	25.55	1.86	24.87	1.90	24.18	1.93	23.49	1.97		

AFR	m <sup>3</sup> /h	1,000
-----	-------------------	-------

Outdoor temperature		Indoor temperature											
		°CDB	°CWB	15.6		18.3		21.1		22.2		23.9	
				TC kW	IP kW	TC kW	IP kW	TC kW	IP kW	TC kW	IP kW	TC kW	IP kW
-15.0	-16.1	6.68	3.02	6.51	3.08	6.33	3.15	6.16	3.21	5.98	3.27		
-10.0	-11.1	7.17	2.96	6.98	3.01	6.80	3.08	6.61	3.14	6.42	3.20		
-5.0	-7.2	7.66	2.89	7.46	2.94	7.26	3.01	7.06	3.07	6.86	3.12		
0.0	-2.2	8.15	2.82	7.94	2.87	7.72	2.94	7.51	2.99	7.30	3.05		
5.0	2.8	8.64	2.75	8.42	2.81	8.19	2.87	7.96	2.92	7.74	2.97		
8.3	6.1	8.97	2.71	8.73	2.76	8.50	2.82	8.26	2.87	8.03	2.93		
10.0	8.3	9.13	2.69	8.89	2.74	8.65	2.80	7.29	2.85	7.29	2.91		
15.0	10.0	8.61	2.34	8.38	2.38	8.16	2.43	7.29	2.48	7.29	2.53		
20.0	15.0	8.09	2.06	7.88	2.10	7.67	2.14	7.29	2.18	7.25	2.23		
24.0	18.0	7.69	1.82	7.49	1.86	7.29	1.90	7.09	1.93	6.89	1.97		

### Model: ASUH24LMAS

AFR	CFM	730
-----	-----	-----

Outdoor temperature		Indoor temperature											
		°FDB	°FDB	60		65		70		72		75	
				TC kBtu	IP kW	TC kBtu	IP kW	TC kBtu	IP kW	TC kBtu	IP kW	TC kBtu	IP kW
5	3	26.91	3.46	26.20	3.52	25.50	3.60	24.80	3.67	24.09	3.74		
14	12	29.51	3.44	28.74	3.51	27.96	3.58	27.19	3.65	26.42	3.72		
23	19	32.11	3.43	31.27	3.49	30.43	3.57	29.59	3.64	28.75	3.71		
32	28	34.71	3.41	33.80	3.48	32.89	3.55	31.98	3.62	31.08	3.69		
41	37	37.31	3.40	36.33	3.46	35.36	3.54	34.38	3.61	33.40	3.67		
47	43	39.04	3.39	38.02	3.46	37.00	3.53	35.98	3.60	34.96	3.66		
50	47	39.78	3.38	38.74	3.45	37.70	3.52	32.75	3.59	32.75	3.65		
59	50	37.90	2.98	36.91	3.04	35.92	3.10	32.75	3.16	32.75	3.22		
68	59	36.02	2.58	35.08	2.63	34.13	2.68	32.75	2.73	32.25	2.79		
75	64	34.56	2.34	33.65	2.38	32.75	2.44	31.84	2.48	30.94	2.53		

AFR	m <sup>3</sup> /h	1,240
-----	-------------------	-------

Outdoor temperature		Indoor temperature											
		°CDB	°CWB	15.6		18.3		21.1		22.2		23.9	
				TC kW	IP kW	TC kW	IP kW	TC kW	IP kW	TC kW	IP kW	TC kW	IP kW
-15.0	-16.1	7.89	3.46	7.68	3.52	7.47	3.60	7.27	3.67	7.06	3.74		
-10.0	-11.1	8.65	3.44	8.42	3.51	8.20	3.58	7.97	3.65	7.74	3.72		
-5.0	-7.2	9.41	3.43	9.16	3.49	8.92	3.57	8.67	3.64	8.43	3.71		
0.0	-2.2	10.17	3.41	9.91	3.48	9.64	3.55	9.37	3.62	9.11	3.69		
5.0	2.8	10.93	3.40	10.65	3.46	10.36	3.54	10.08	3.61	9.79	3.67		
8.3	6.1	11.44	3.39	11.14	3.46	10.84	3.53	10.54	3.60	10.25	3.66		
10.0	8.3	11.66	3.38	11.35	3.45	11.05	3.52	9.60	3.59	9.60	3.65		
15.0	10.0	11.11	2.98	10.82	3.04	10.53	3.10	9.60	3.16	9.60	3.22		
20.0	15.0	10.56	2.58	10.28	2.63	10.00	2.68	9.60	2.73	9.45	2.79		
24.0	18.0	10.13	2.34	9.86	2.38	9.60	2.44	9.33	2.48	9.07	2.53		

# 5. Fan performance

## 5-1. Air velocity distributions

### ■ Model: ASUH18LMAS

Measuring conditions	Fan speed	Operation mode
	HIGH	FAN

Top view  
Vertical airflow direction louver: Up  
Horizontal airflow direction louver: Center

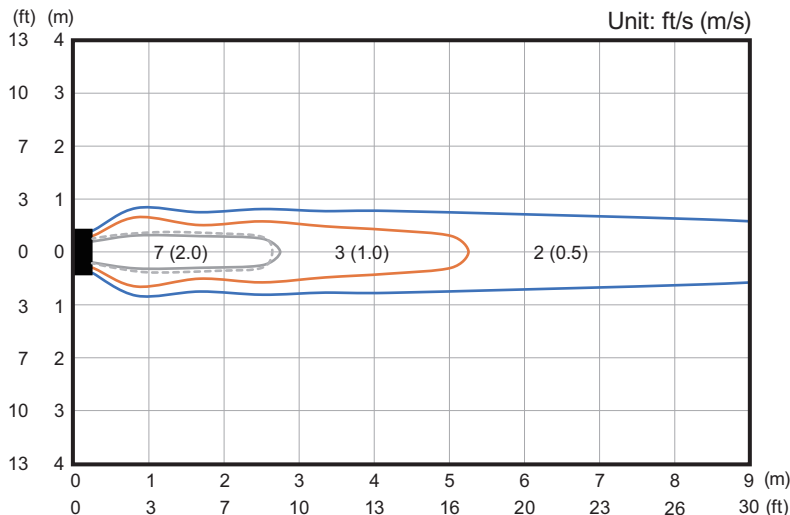

Top view  
Vertical airflow direction louver: Up  
Horizontal airflow direction louver: Left & Right

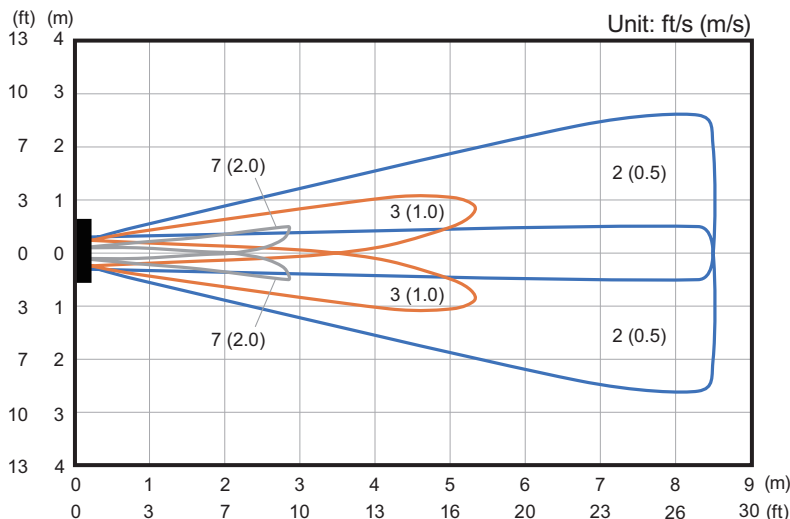

Side view  
Vertical airflow direction louver: Up  
Horizontal airflow direction louver: Center

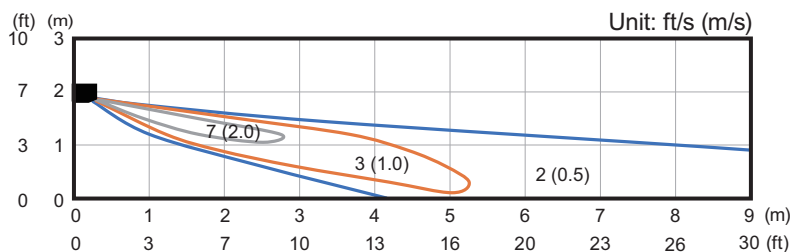

Side view  
Vertical airflow direction louver: Down  
Horizontal airflow direction louver: Center

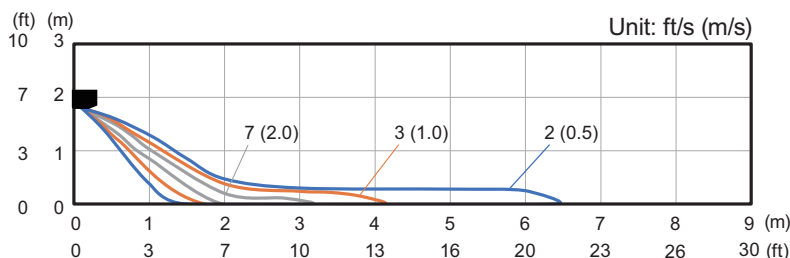



# Model: ASUH24LMAS

Measuring conditions	Fan speed	Operation mode
	HIGH	FAN

Top view  
Vertical airflow direction louver: Up  
Horizontal airflow direction louver: Center

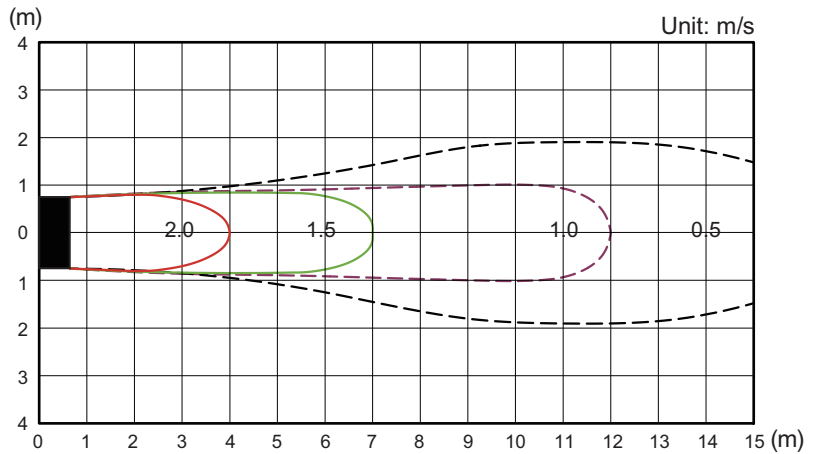

Top view  
Vertical airflow direction louver: Up  
Horizontal airflow direction louver: Left & Right

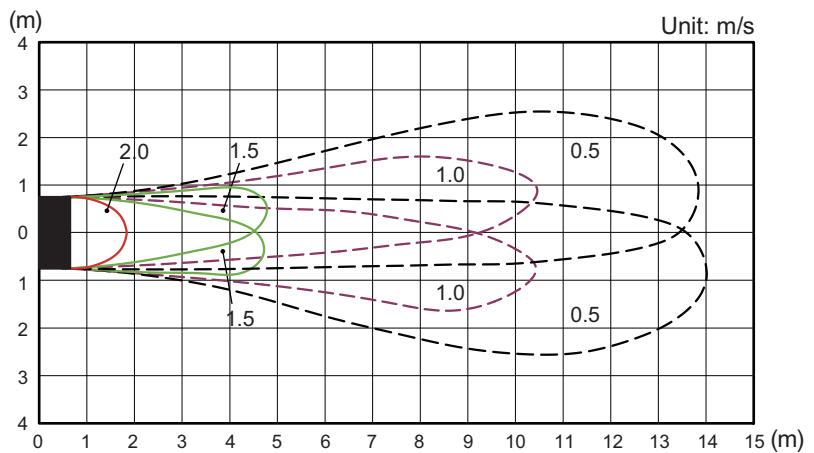

Side view  
Vertical airflow direction louver: Up  
Horizontal airflow direction louver: Center

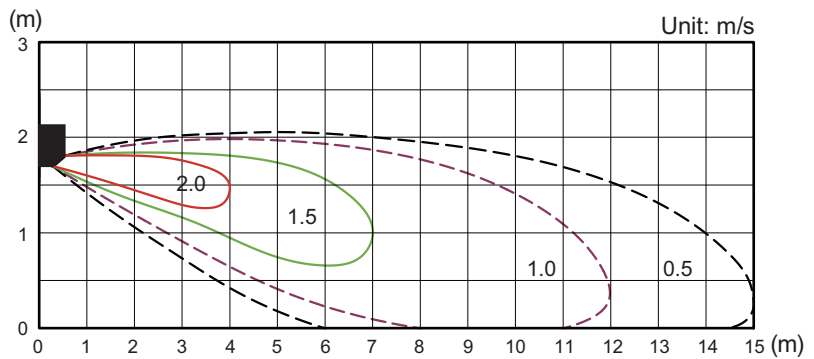

Side view  
Vertical airflow direction louver: Down  
Horizontal airflow direction louver: Center

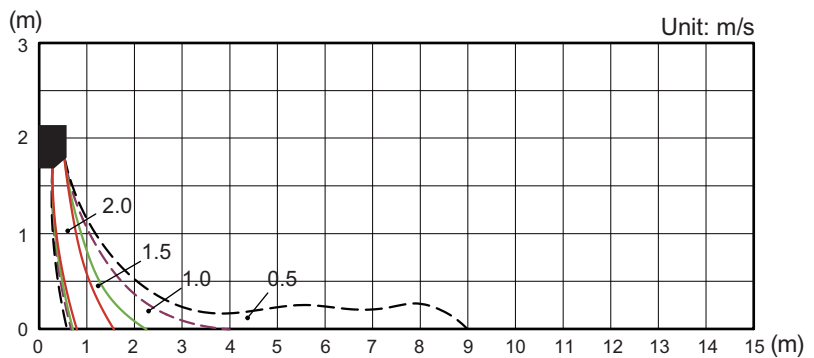

## 5-2. Airflow

### ■ Model: ASUH18LMAS

#### ● Cooling

Fan speed	Airflow	
HIGH	m <sup>3</sup> /h	980
	l/s	272
	CFM	577
MED	m <sup>3</sup> /h	830
	l/s	231
	CFM	489
LOW	m <sup>3</sup> /h	640
	l/s	178
	CFM	377
QUIET	m <sup>3</sup> /h	510
	l/s	142
	CFM	300

#### ● Heating

Fan speed	Airflow	
HIGH	m <sup>3</sup> /h	1,000
	l/s	278
	CFM	589
MED	m <sup>3</sup> /h	850
	l/s	236
	CFM	500
LOW	m <sup>3</sup> /h	640
	l/s	178
	CFM	377
QUIET	m <sup>3</sup> /h	510
	l/s	142
	CFM	300

## ■ Model: ASUH24LMAS

### ● Cooling

Fan speed	Airflow	
HIGH	m <sup>3</sup> /h	1,100
	l/s	306
	CFM	647
MED	m <sup>3</sup> /h	900
	l/s	250
	CFM	530
LOW	m <sup>3</sup> /h	740
	l/s	206
	CFM	436
QUIET	m <sup>3</sup> /h	630
	l/s	175
	CFM	371

### ● Heating

Fan speed	Airflow	
HIGH	m <sup>3</sup> /h	1,240
	l/s	344
	CFM	730
MED	m <sup>3</sup> /h	900
	l/s	250
	CFM	530
LOW	m <sup>3</sup> /h	740
	l/s	206
	CFM	436
QUIET	m <sup>3</sup> /h	630
	l/s	175
	CFM	371

# 6. Operation noise (sound pressure)

## 6-1. Noise level curve

### Model: ASUH18LMAS

#### Cooling

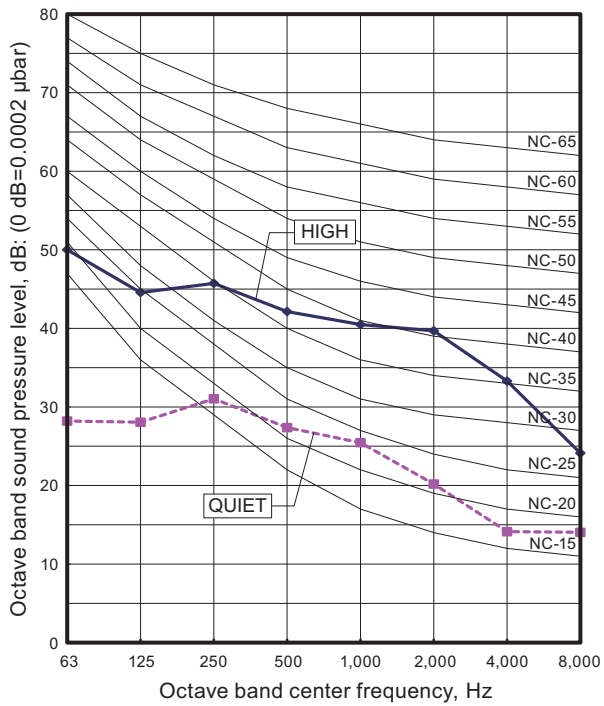

#### Heating

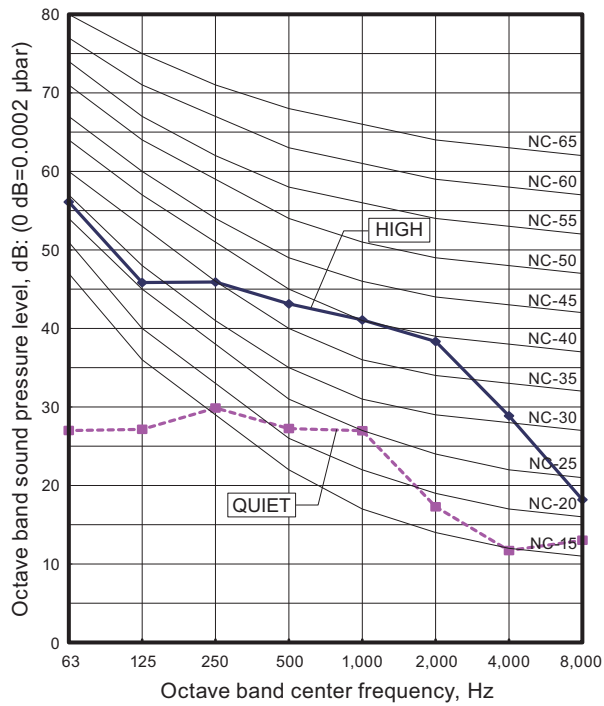

### Model: ASUH24LMAS

#### Cooling

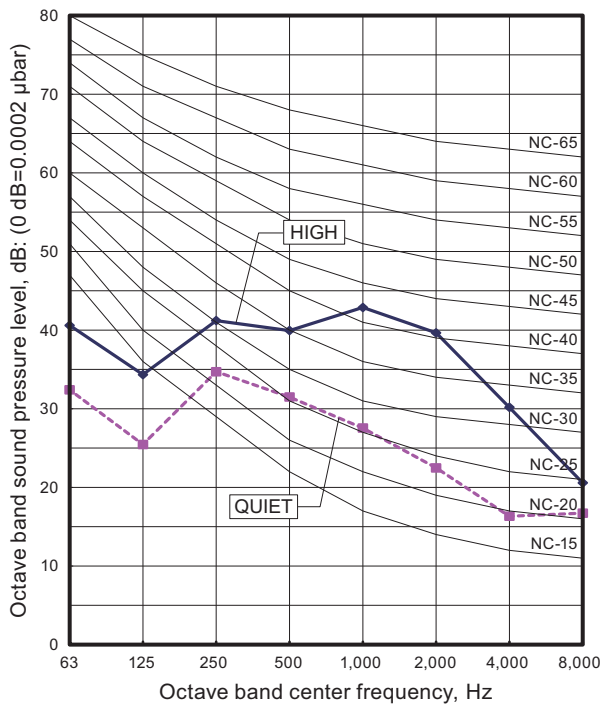

#### Heating

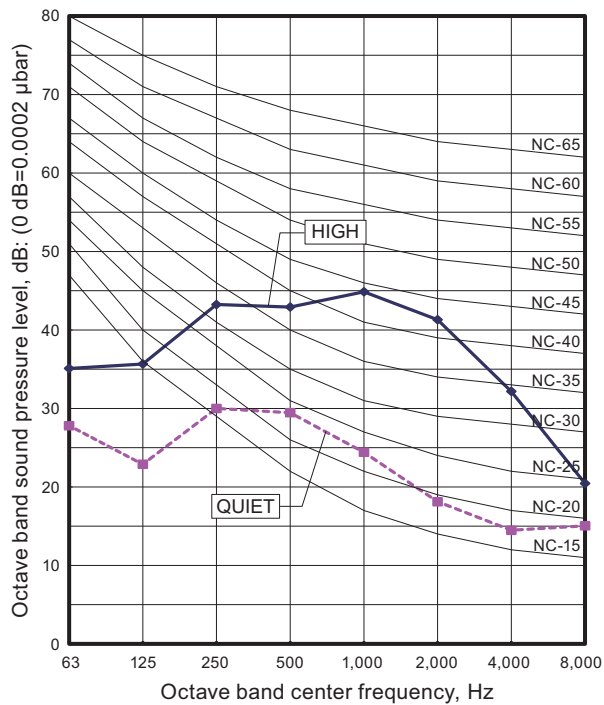

## 6-2. Sound level check point

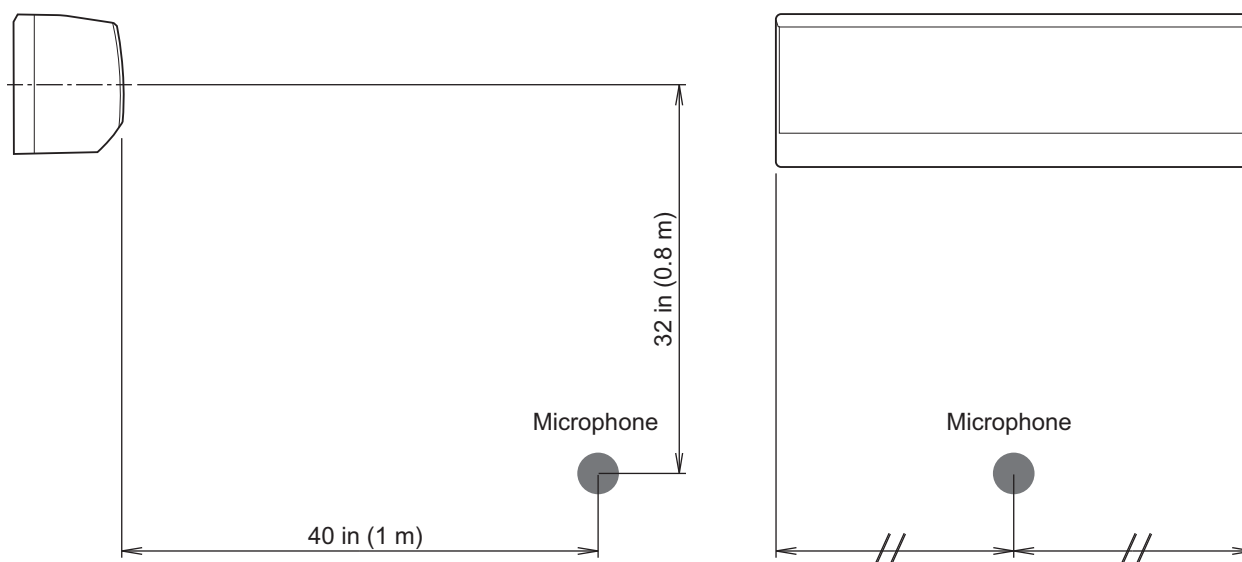

**NOTE:** Detailed shape of the actual indoor unit might be slightly different from the one illustrated above.

## 7. Safety devices

Type of protection	Protection form		Model	
			ASUH18LMAS	ASUH24LMAS
Circuit protection	Current fuse (PCB*)		250 V, 3.15 A	
Fan motor protection	Thermal protection	Activate	257±18°F (125±10°C) Fan motor stop	
		Reset	212±18°F (100±10°C) Fan motor restart	

\*PCB: Printed Circuit Board

# 8. External input and output

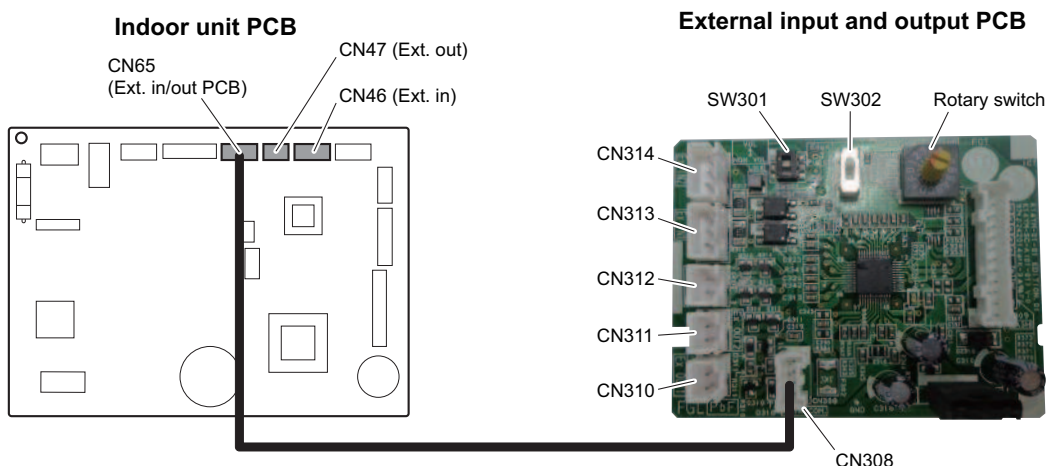

PCB	External input	External output	Connector	Input select	Input signal
Indoor unit	Operation/Stop	—	CN46	Dry contact	Edge
	Forced stop				
	—	Operation status	CN47	—	—
		Error status			
		Indoor unit fan operation status			
		Cooling thermostat On			
		Heating thermostat On			
External heater output					
Set point attainment status					
External input and output (UTY-XCSXZ2)	Operation/Stop	—	CN313/ CN314	Dry contact/ Apply voltage	Edge/Pulse
	Forced stop		CN313		Edge
	Forced thermostat off				
	—	Operation status	CN310/ CN311/ CN312	—	—
		Error status			
		Indoor unit fan operation status			
		External heater output			
Remote controller output					
Cooling high/low output					
Heating thermostat On					

## 8-1. External input

With using external input function, some functions on this product can be controlled from an external device.

- "Operation/Stop" mode or "Forced stop" mode can be selected with function setting of indoor unit.
- A twisted pair cable (22AWG) should be used. Maximum length of cable is 492 ft (150 m).
- The wire connection should be separate from the power cable line.

### ■ Indoor unit

Indoor unit functions such as Operation/Stop can be done by using indoor unit connectors.

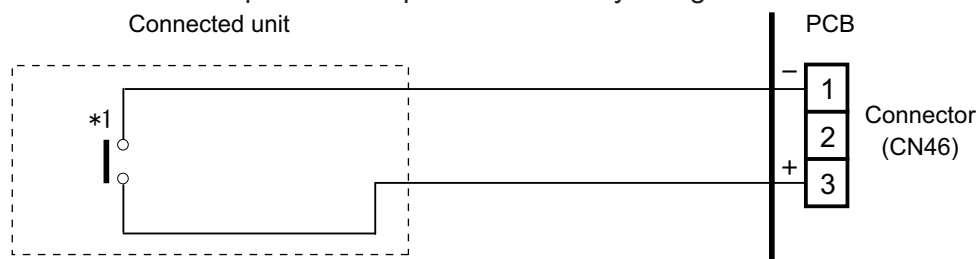

\*1: The switch can be used on the following condition: DC 12 V to 24 V, 1 mA to 15 mA.



## External input and output PCB

The indoor unit Operation/Stop can be set by using the input connector on the PCB.

### Input select:

Use either one of these types of connectors according to the application. (Both types of connectors cannot be used simultaneously.)

#### – Dry contact

In case of internal power supply, set the slide switch of SW301 to "NON VOL" side.

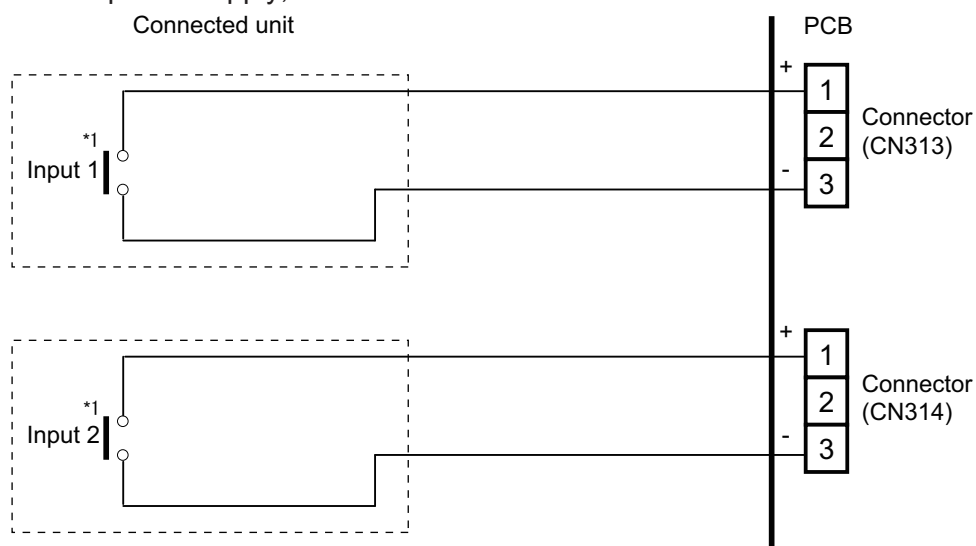

\*1: The switches can be used on the following condition: DC 12 V to 24 V, 1 mA to 15 mA.

#### – Apply voltage

In case of external power supply, set the slide switch of SW301 to "VOL" side.

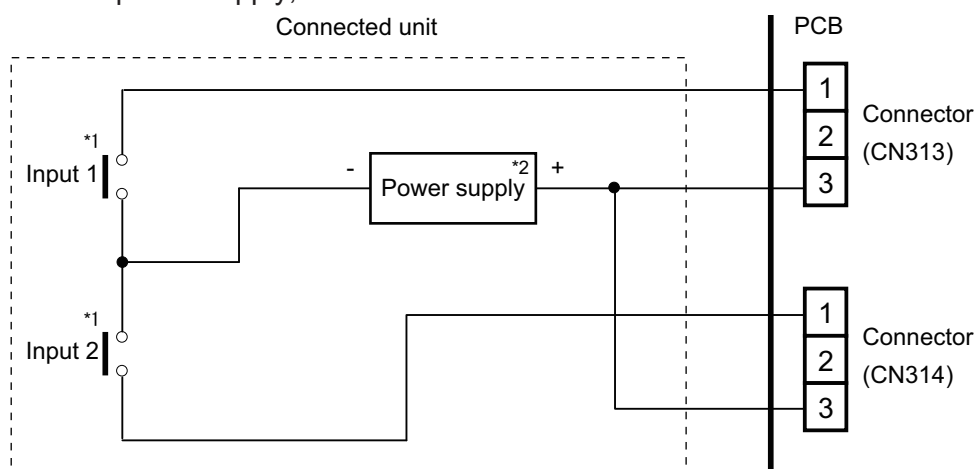

\*1: The switches can be used on the following condition: DC 12 V to 24 V, 1 mA to 15 mA.

\*2: Make the power supply DC 12 to 24 V, 10 mA or more.

## 8-2. External output

Use an external output cable with appropriate external dimension, depending on the number of cables to be installed.

### Indoor unit

- A twisted pair cable (22AWG) should be used. Maximum length of cable is 82 ft (25 m).
- Output voltage: High DC 12 V  $\pm$  2 V, Low 0 V.
- Permissible current: 50 mA
- For details, refer to ["Combination of external input and output"](#) on page 24.

### When indicator or other components are connected directly

**Example:** Function setting 60 is set to "00"

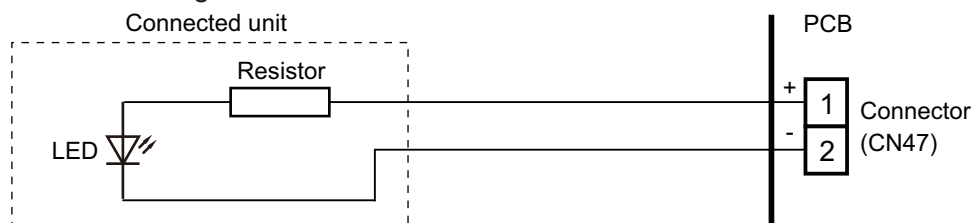

### When connecting with a device equipped with a power supply

**Example:** Function setting 60 is set to "00"

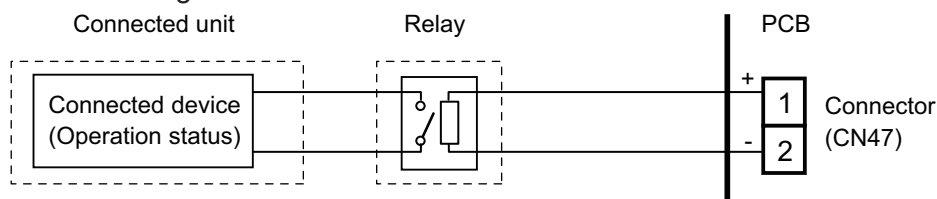

## External input and output PCB

- A twisted pair cable (22AWG) should be used. Maximum length of cable is 82 ft (25 m).
  - Output voltage: High DC 12 V±2 V, Low 0 V.
  - Permissible current: 50 mA
  - For details, refer to "[Combination of external input and output](#)" on page 24.
- **When indicator or other components are connected directly:**  
**Example:** Rotary SW on External input and output PCB is set to "1".

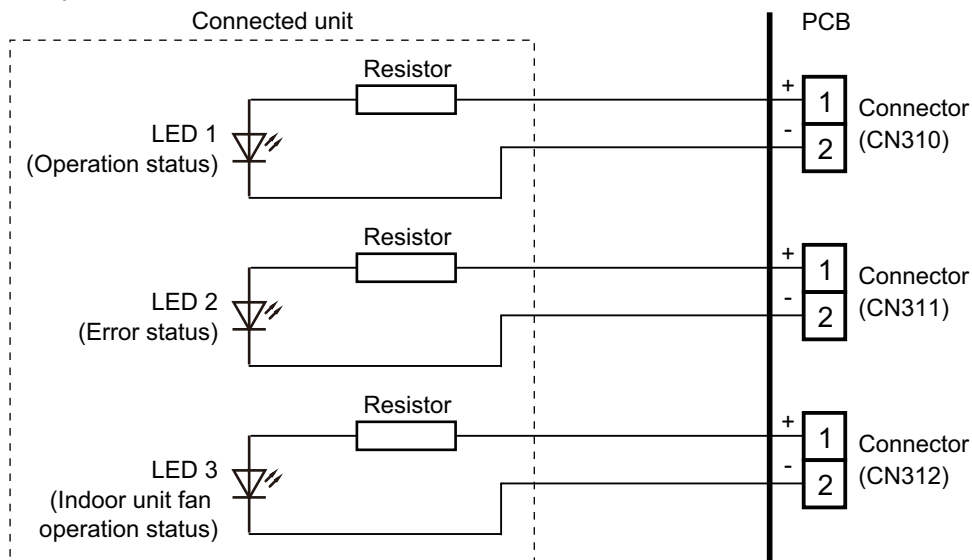

- **When connecting with a device equipped with a power supply:**  
**Example:** Rotary SW on External input and output PCB is set to "1".

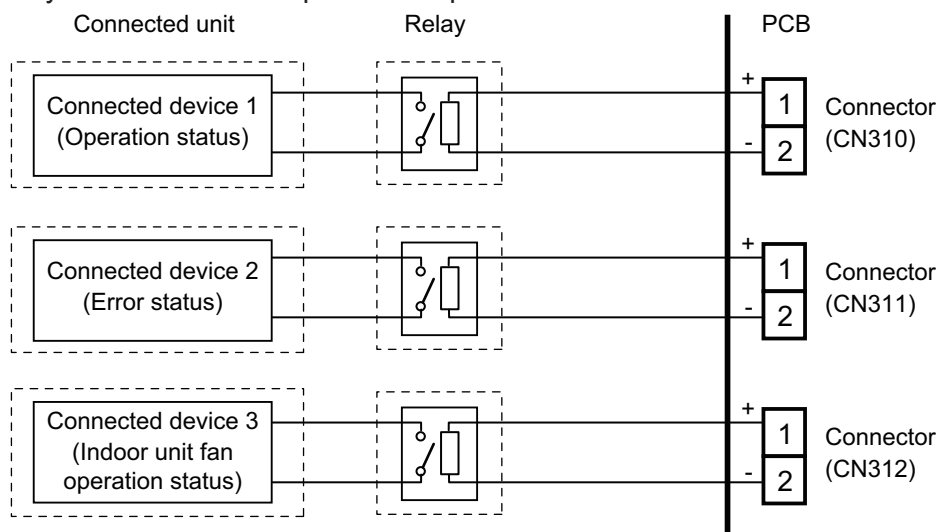

## 8-3. Combination of external input and output

By combining the function setting of the indoor unit and rotary switch setting of the External input and output PCB, you can select various combinations of functions.

Combination examples of external input and output are as follows:

Mode	Function setting	Rotary SW	External input		
			Indoor unit	External input and output PCB	
			CN46	1 CN313	2 CN314
0-1	60—00	1	Operation/Stop (Function setting 46-00) or Forced stop (Function setting 46-02)	Operation/Stop	Not available
0-2	60-00	2		Operation	Stop
1	60-01	3		Forced thermostat Off	Not available
2	60-02	4		Mechanical cooling Off	
3	60-03	5		Forced thermostat Off	
4	60-04	6		Mechanical cooling On	
5	60-05	7		Mechanical cooling On	
6	60-06	8		Forced thermostat Off	
7	60-07	9		Forced thermostat Off	
8	60-08	A		Mechanical cooling Off	
9	60-09	B		Forced thermostat Off	
10	60-10	C		Forced thermostat Off	
11	60-11	D	Forced thermostat Off		
12	60-12	D	Forced thermostat Off		

**NOTE:** Input of Operation/Stop depends on the setting of function setting 46.

- 00: Operation/Stop mode 1 (R.C. enabled)
- 01: (Setting prohibited)
- 02: Forced stop
- 03: Operation/Stop mode 2 (R.C. disabled)

Mode	Function setting	Rotary SW	External output			
			Indoor unit	External input and output PCB		
			CN47	1 CN310	2 CN311	3 CN312
0-1	60-00	1	Operation/Stop	Operation/Stop	Error status	Indoor unit fan operation status
0-2	60-00	2	Operation/Stop	Error status	Indoor unit fan operation status	External heater output
1	60-01	3	Cooling thermostat On	Error status	Indoor unit fan operation status	External heater output
2	60-02	4	Cooling thermostat On	Error status	Remote controller output	External heater output
3	60-03	5	Cooling thermostat On	Cooling high/low output	Remote controller output	External heater output
4	60-04	6	Cooling thermostat On	Error status	Remote controller output	Cooling high/low output
5	60-05	7	Heating thermostat On	Error status	Indoor unit fan operation status	External heater output
6	60-06	8	Operation/Stop	Error status	Indoor unit fan operation status	Heating thermostat On
7	60-07	9	Cooling thermostat On	Error status	Heating thermostat On	External heater output
8	60-08	A	Cooling thermostat On	Heating thermostat On	Remote controller output	External heater output
9	60-09	B	Error status	Operation/Stop	Indoor unit fan operation status	External heater output
10	60-10	C	Indoor unit fan operation status	Operation/Stop	Error status	External heater output
11	60-11	D	External heater output	Operation/Stop	Indoor unit fan operation status	Error status
12	60-12	D	Set point attainment status	Operation/Stop	Indoor unit fan operation status	Error status

## Input signal type

### External input and output PCB:

The input signal type can be selected.

Signal type (edge or pulse) can be switched by the DIP switch SW302 on the External input and output PCB.

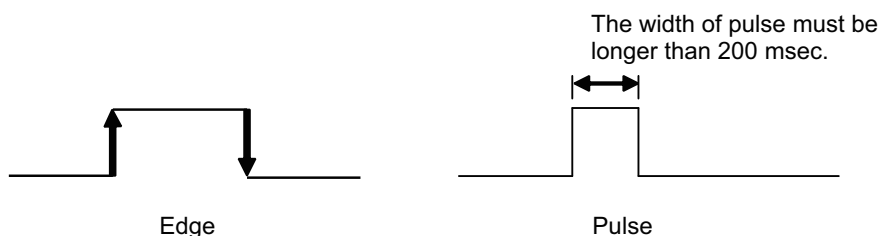

## 8-4. Details of function

### ■ Control input function

- When function setting is “Operation/Stop” mode 1
  - In the case of “Edge” input:

Function setting	Rotary SW on External input and output PCB	External input		Input signal	Command
		External input and output PCB	CN313		
46-00	1			Off → On	Operation
				On → Off	Stop

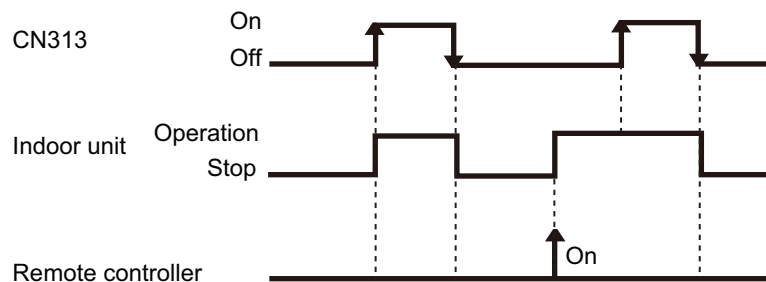

- In the case of “Pulse” input:

Function setting	Rotary SW on External input and output PCB	External input		Input signal	Command
		External input and output PCB	CN313		
46-00	1		CN313	Pulse	Operation
			CN314	Pulse	Stop

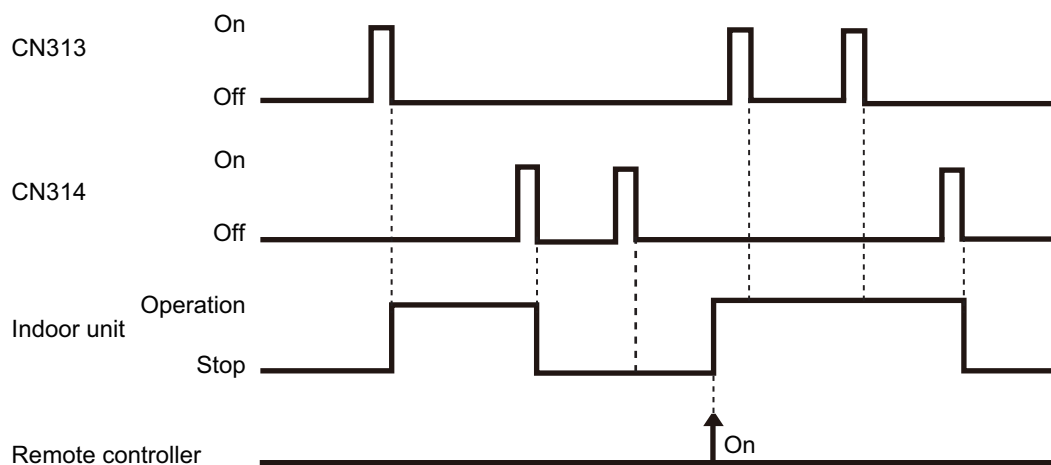

#### NOTES:

- The last command has priority.
- The indoor units within the same remote controller group operates in the same mode.

• When function setting is “Forced stop” mode

– In the case of “Edge” input:

Function setting	Rotary SW on External input and output PCB	External input		Input signal	Command
		External input and output PCB	CN313		
46-02	1			Off → On	Forced stop
				On → Off	Normal

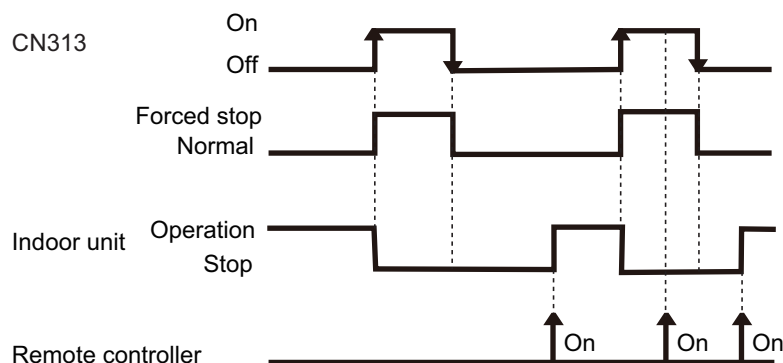

– In the case of “Pulse” input:

Function setting	Rotary SW on External input and output PCB	External input		Input signal	Command
		External input and output PCB	CN313 CN314		
46-02	1		CN313	Pulse	Forced stop
			CN314	Pulse	Normal

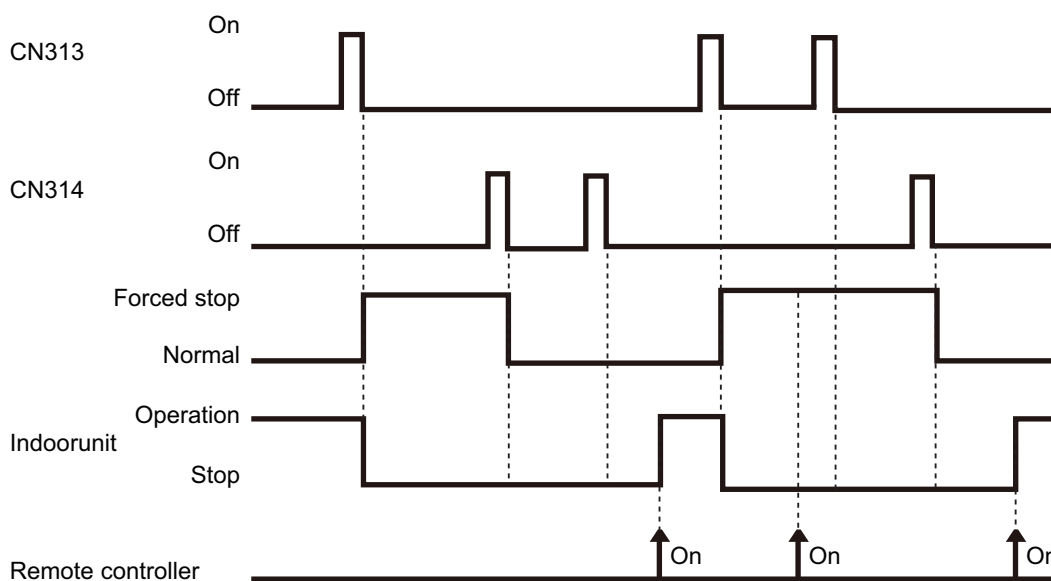

**NOTES:**

- When the forced stop is triggered, indoor unit stops and Operation/Stop operation by the remote controller is restricted.
- When forced stop function is used with forming a remote controller group, connect the same equipment to each indoor unit within the group.

• When function setting is “Operation/Stop” mode 2

– In the case of “Edge” input:

Function setting	Rotary SW on External input and output PCB	External input		Input signal	Command
46-03	1	External input and output PCB	CN313	Off → On	Operation
				On → Off	Stop (R.C. disabled)

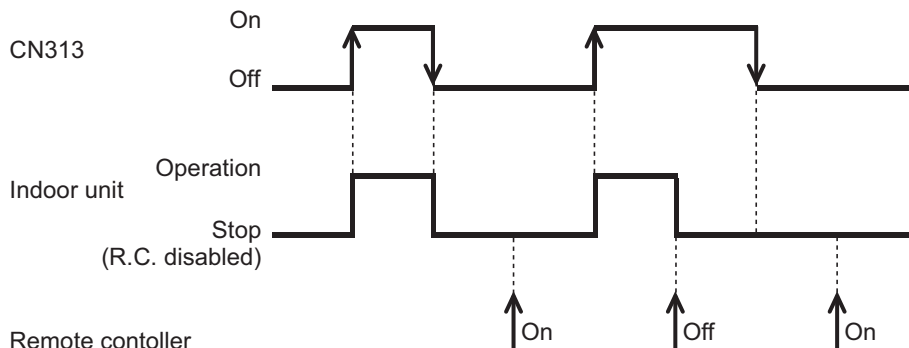

– In the case of “Pulse” input:

Function setting	Rotary SW on External input and output PCB	External input		Input signal	Command
46-03	1	External input and output PCB	CN313	Pulse	Operation
			CN314	Pulse	Stop (R.C. disabled)

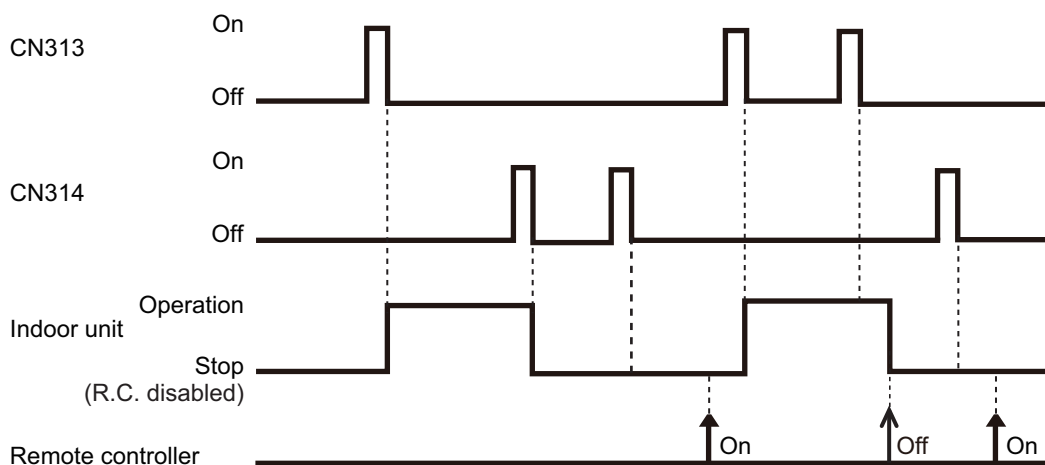

**NOTE:** When “Operation/Stop” mode 2 function is used with forming a remote controller group, connect the same equipment to each indoor unit within the group.



• Forced thermostat off function

Function setting / Rotary SW on External input and output PCB	External input		Input signal	Command
60-00 / 2 60-09 / B 60-10 / C 60-11 / D 60-12 / D	External input and output PCB	CN313	Off → On	Thermostat off
On → Off			Normal operation	

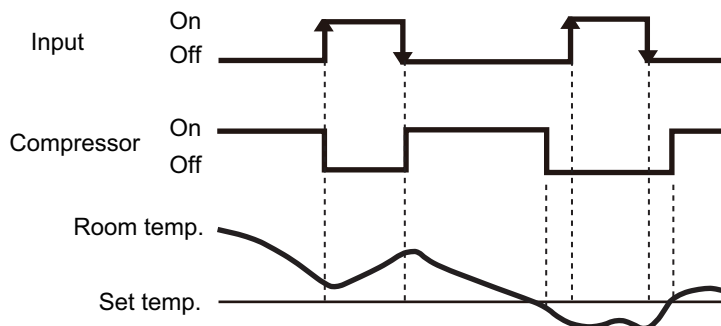

■ Control output function

• Operation/Stop status

Function setting / Rotary SW on External input and output PCB	External output		Output signal	Command
60-00 / 2	Output of indoor unit	CN47	Off → On	Operation
			On → Off	Stop
60-00 / 1 60-09 / B 60-10 / C 60-11 / D 60-12 / D	External input and output PCB	CN310	Off → On	Operation
			On → Off	Stop

The output is low when the unit is stopped.

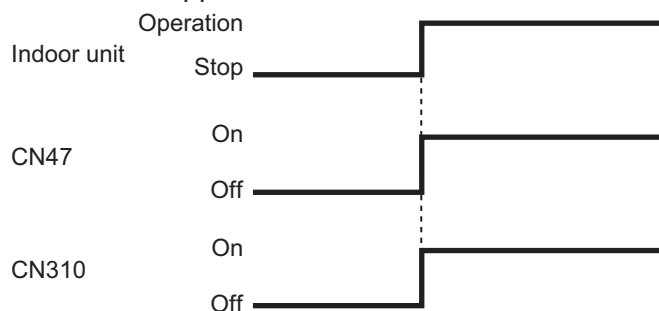

- Error status

Function setting / Rotary SW on External input and output PCB	External output		Output signal	Command
60-09 / B	Output of indoor unit	CN47	Off → On	Error
			On → Off	Normal
60-00 / 2	External input and output PCB	CN310	Off → On	Error
			On → Off	Normal
CN311		Off → On	Error	
		On → Off	Normal	
60-00 / 1 60-09 / B 60-10 / C		CN312	Off → On	Error
			On → Off	Normal
60-11 / D 60-12 / D		CN312	Off → On	Error
			On → Off	Normal

The output is ON when an error is generated for the indoor unit.

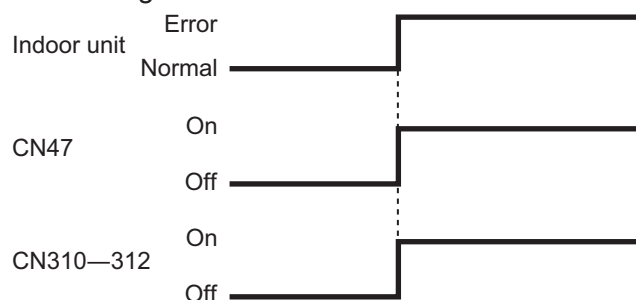

- Indoor unit fan operation status

Function setting / Rotary SW on External input and output PCB	External output		Output signal	Command
60-10 / C	Output of indoor unit	CN47	Off → On	Fan run
			On → Off	Fan stop
60-00 / 2 60-09 / B 60-11 / D 60-12 / D	External input and output PCB	CN311	Off → On	Fan run
			On → Off	Fan stop
		CN312	Off → On	Fan run
			On → Off	Fan stop
60-00 / 1		CN312	Off → On	Fan run
On → Off			Fan stop	

Output signal	Condition
On Low → High	The indoor unit fan is operating.
Off High → Low	The fan is stopped or during cold air prevention. During thermostat off when in dry mode operation.

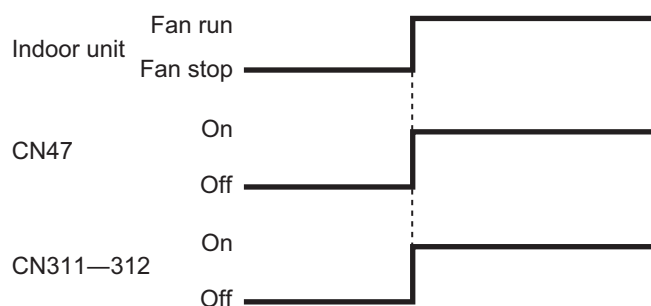

- External heater output

Function setting / Rotary SW on External input and output PCB	External output		Output signal	Command
60-11 / D	Output of indoor unit	CN47	Off → On	Heater on
			On → Off	Heater off
60-00 / 2 60-09 / B 60-10 / C	External input and output PCB	CN312	Off → On	Heater on
			On → Off	Heater off

- Set point attainment status

**NOTE:** This function is valid only when function setting 96 is set to “Enable” (01).

When the room temperature does not reach the set point at a room due to the lower cooling performance caused by external factor such as the outdoor temperature change, signal is output to tell the attainment status of set point.

Function setting / Rotary SW on External input and output PCB	External output		Output signal	Command
60-12 / D	Output of indoor unit	CN47	On → Off	Normal
			Off → On	Set point attainment

Output signal	Condition
Off	Reached the set point. ( $Tr \leq Tsa + 1^\circ F [0.5^\circ C]$ )
On	Unreached the set point. ( $Tr > Tsa + 5^\circ F [2.5^\circ C]$ ) However, even if the set point unreached, the signal will not be output for 7 minutes after power is turned on.

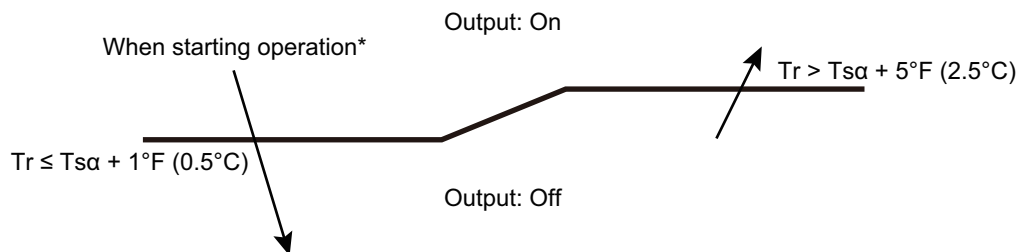

\*: When starting operation or resetting, judges the zone to descending direction.

## External heater output

Control	Primary heater	Auxiliary heater	Function setting	
			Indoor unit	Wired R. C.
			Control switching external heaters No. 61	Sensor activation*2
Auxiliary heater control 1	Heat pump	External device*1	61-00	—
Auxiliary heater control 2	Heat pump	External device	61-01	—
Heat pump prohibition control	External device	None	61-02	On (Enabled)
Auxiliary heater control by outdoor temperature 1	Heat pump	External device	61-03	On (Enabled)
Auxiliary heater control by outdoor temperature 2	Heat Pump	External device	61-04	On (Enabled)
Auxiliary heater control by outdoor temperature 3	Heat Pump	External device	61-05	On (Enabled)
Auxiliary heat pump control	External device	Heat pump	61-06	On (Enabled)
Auxiliary heat pump control by outdoor temperature 1	External device	Heat pump	61-07	On (Enabled)
Auxiliary heat pump control by outdoor temperature 2	External device	Heat pump	61-08	On (Enabled)
Auxiliary heat pump control by outdoor temperature 3	External device	Heat pump	61-09	On (Enabled)

### NOTES:

- After turning off the heater, 3 minutes of standby time is required by next power-on of the heater.
- For items marked “—” in the table, any of validate or invalidate of the setting are acceptable.
- \*1: External device means Hot water, Electrical heater, etc.
- \*2: Sensor activation:
  - Setting change from the factory setting is required.
  - Indoor unit fan setting will be on for safety reason without sensor activation of wired remote controller.

## Installation configuration of individual connection

External heating device is installed individually. (No use of indoor unit fan)

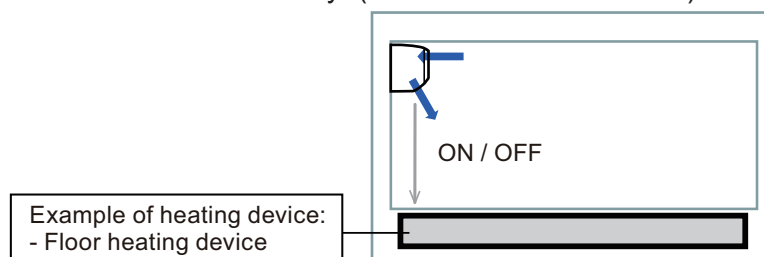

**⚠ WARNING**

- Design and install external heater appropriately with considering its protection.
- Inappropriate designing and installation of external heater may cause a fire by emitted heat from the external heater.
- Fujitsu General Ltd. is not responsible for inappropriate designing or installation of external heating device.

**● Auxiliary heater control 1**

Operation	Condition
Heater on	Heater is on as shown in following diagram of heating temperature.
Heater off	<ul style="list-style-type: none"> <li>• Heater is off as shown in following diagram of heating temperature.</li> <li>• Other than heating mode</li> <li>• Error occurred</li> <li>• Forced thermostat off</li> <li>• Fan stop protection</li> </ul>

- Temperature of heater on (Thon): Adjustable by function number 62 (Operating temperature switching of external heaters).
- All control temperatures will shift by adjusting “Thon”.

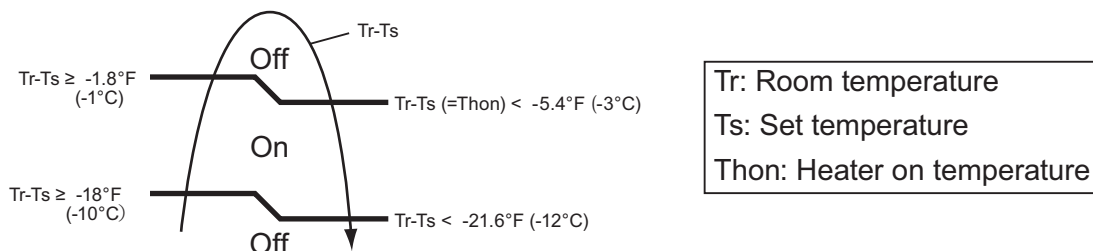

**Example:** When set temperature (Ts) is 72°F (22°C) (Factory setting),

- and room temperature (Tr) increases above 53.6°F (12°C), signal output is on.
- and room temperature (Tr) increases above 69.8°F (21°C), signal output is off.
- and room temperature (Tr) decreases below 66.2°F (19°C), signal output is on.
- and room temperature (Tr) decreases below 50°F (10°C), signal output is off.

**● Auxiliary heater control 2**

Operation	Condition
Heater on	Heater is on as shown in following diagram of heating temperature.
Heater off	<ul style="list-style-type: none"> <li>• Heater is off as shown in following diagram of heating temperature.</li> <li>• Other than heating mode</li> <li>• Error occurred</li> <li>• Forced thermostat off</li> <li>• Fan stop protection</li> </ul>

- Temperature of heater on (Thon): Adjustable by function number 62 (Operating temperature switching of external heaters).
- All control temperatures will shift by adjusting “Thon”.

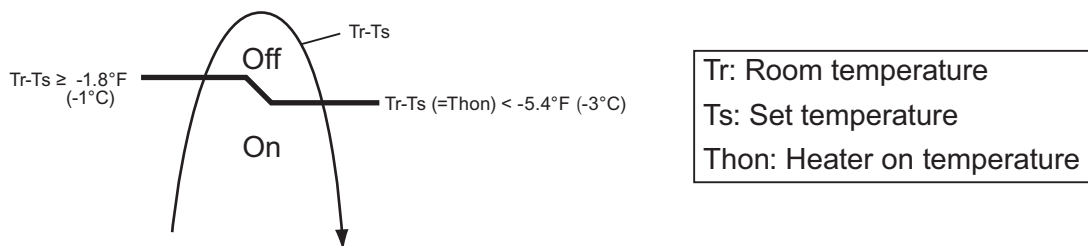

## ● Heat pump prohibition control

Perform heating by external heater only. Indoor unit is continuous thermostat off.

Operation	Condition
Heater on	Heater is on as shown in following diagram of heating temperature.
Heater off	<ul style="list-style-type: none"> <li>• Heater is off as shown in following diagram of heating temperature.</li> <li>• Other than heating mode</li> <li>• Error occurred</li> <li>• Forced thermostat off</li> </ul>

- Temperature of heater on (Thon): Adjustable by function number 62 (Operating temperature switching of external heaters).
- All control temperatures will shift by adjusting “Thon”.

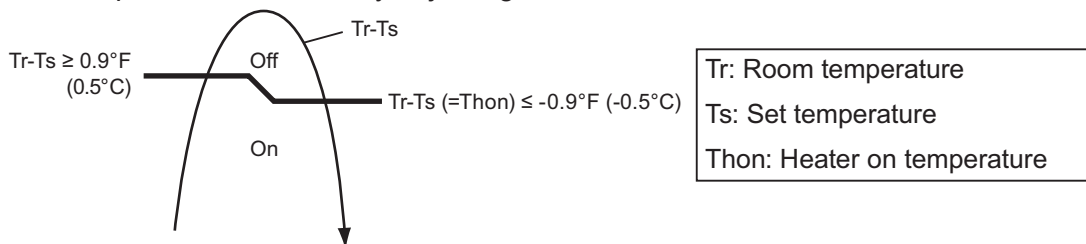

### • Operation status

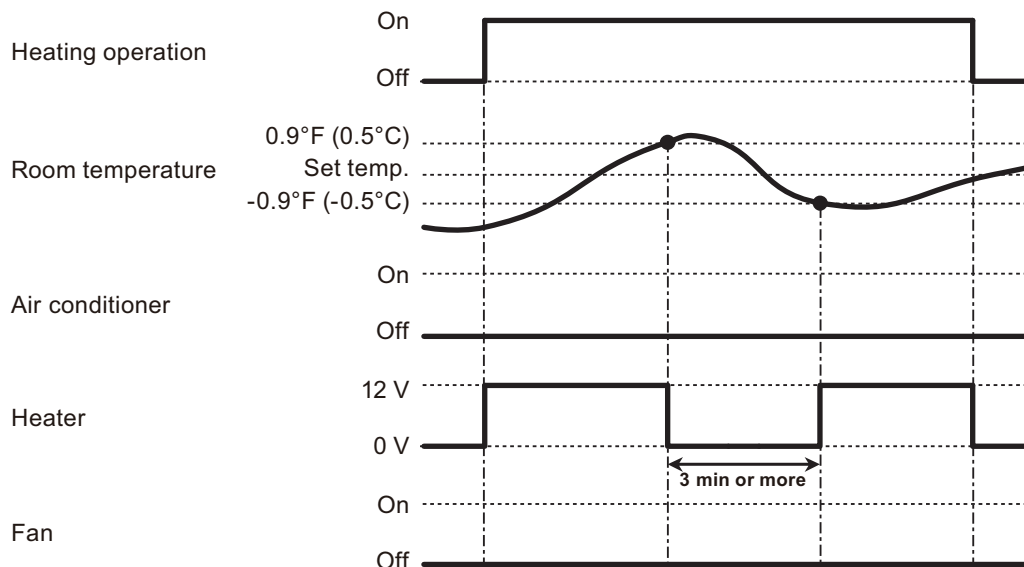

**NOTE:** In following operations, compressor will be on.

- Other than heating
- Test run

# ● Auxiliary heater control by outdoor temperature 1

This control selects heat pump or external heater according to the outdoor temperature. When outdoor temperature is high, the heating is performed by using heat pump only.

Operation	Condition
Heater on	Heater is on as shown in following diagram of heating temperature.
Heater off	<ul style="list-style-type: none"> <li>Heater is off as shown in following diagram of heating temperature.</li> <li>Other than heating mode</li> <li>Error occurred</li> <li>Forced thermostat off</li> <li>Heat pump only zone</li> </ul>

- Temperature of heater on (Thon): Adjustable by function number 62 (Operating temperature switching of external heaters).
- All control temperatures will shift by adjusting "Thon".
- Outdoor temperature zone boundary A and B: Adjustable individually by function setting number 66 and 67.

### • External heater output

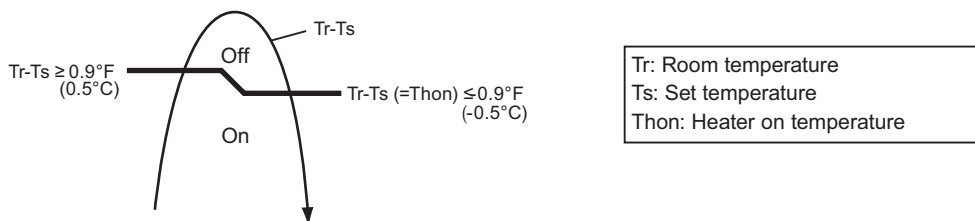

### • Outdoor temperature zone

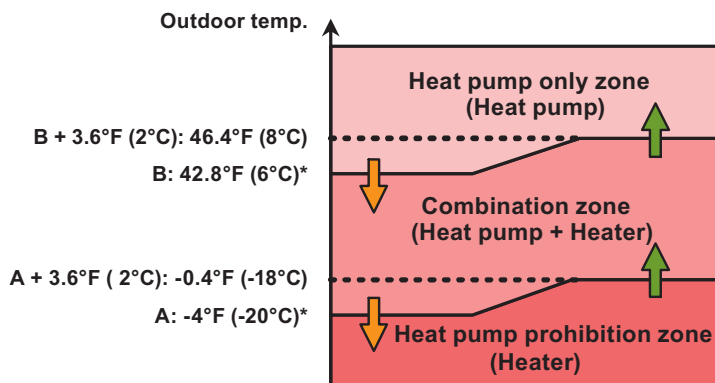

\*: Adjustable by function setting 66 and 67

• Operation status

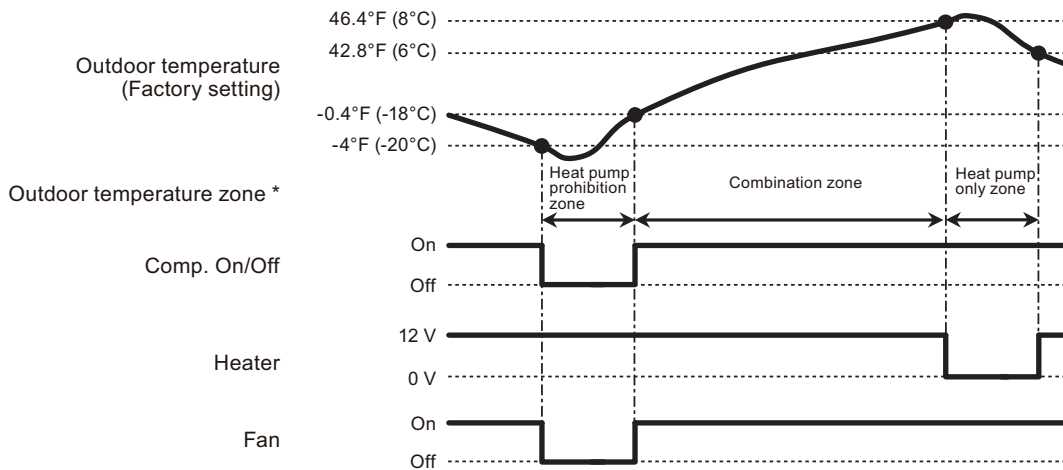

\* The outdoor temperature zone transition from one to another will stay in that zone for minimum of 30 min.

**NOTE:** In following operations, compressor will be on in heat pump prohibition zone.

- Other than heating
- Test run



## ● Auxiliary heater control by outdoor temperature 2

This control selects heat pump or external heater according to the outdoor temperature. Even when outdoor temperature is high, the heating is performed by using both of heat pump and external heater.

Operation	Condition
Heater on	Heater is on as shown in following diagram of heating temperature.
Heater off	<ul style="list-style-type: none"> <li>• Heater is off as shown in following diagram of heating temperature.</li> <li>• Other than heating mode</li> <li>• Error occurred</li> <li>• Forced thermostat off</li> </ul>

- Temperature of heater on (Thon): Adjustable by function number 62 (Operating temperature switching of external heaters).
- All control temperatures will shift by adjusting "Thon".
- Outdoor temperature zone boundary A: Adjustable by function setting number 66.

### • External heater output

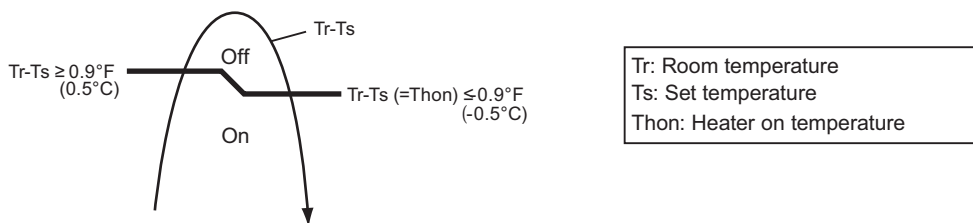

### • Outdoor temperature zone

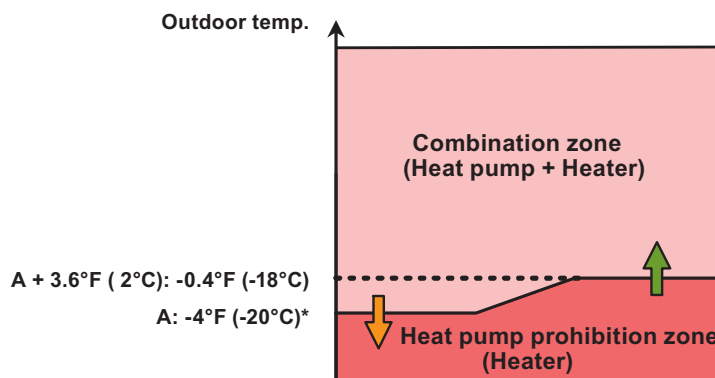

\*: Adjustable by function setting 66

• **Operation status**

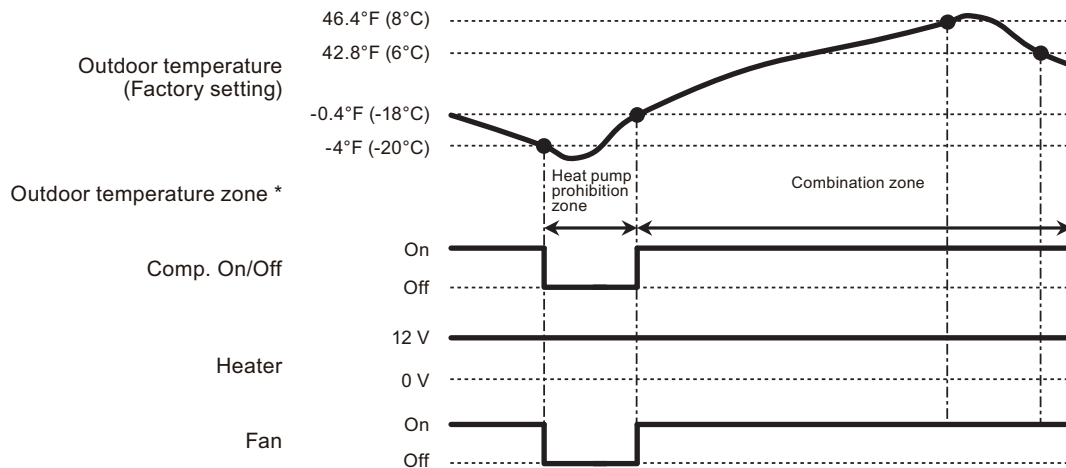

\* The outdoor temperature zone transition from one to another will stay in that zone for minimum of 30 min.

**NOTE:** In following operations, compressor will be on in heat pump prohibition zone.

- Other than heating
- Test run

### ● Auxiliary heater control by outdoor temperature 3

This control selects heat pump or external heater according to the outdoor temperature. Even when outdoor temperature is high, the heating is performed by using both of heat pump and external heater.

Operation	Condition
Heater on	Heater is on as shown in following diagram of heating temperature.
Heater off	<ul style="list-style-type: none"> <li>• Heater is off as shown in following diagram of heating temperature.</li> <li>• Other than heating mode</li> <li>• Error occurred</li> <li>• Forced thermostat off</li> </ul>

- Temperature of heater on (Thon): Adjustable by function number 62 (Operating temperature switching of external heaters).
- All control temperatures will shift by adjusting “Thon”.
- Outdoor temperature zone boundary B: Adjustable by function setting number 67.

#### • External heater output

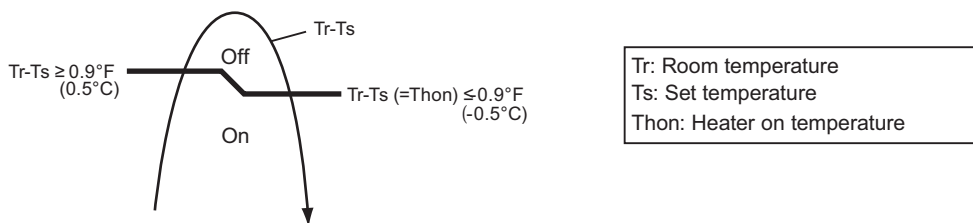

#### • Outdoor temperature zone

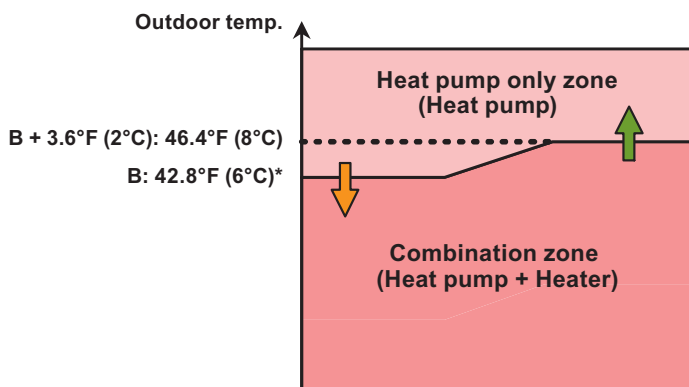

\*: Adjustable by function setting 67

• Operation status

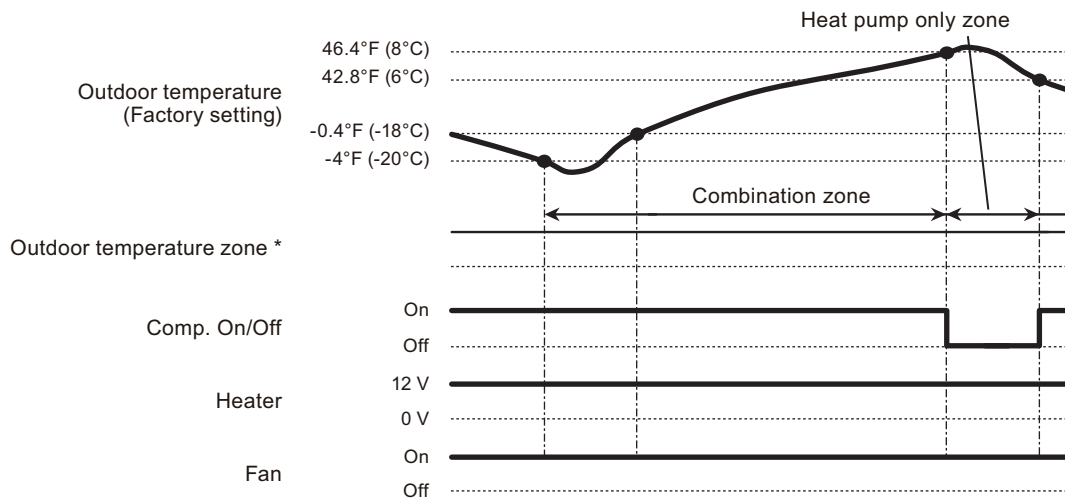

\* The outdoor temperature zone transition from one to another will stay in that zone for minimum of 30 min.

**NOTE:** In following operations, compressor will be on in heat pump prohibition zone.

- Other than heating
- Test run

## ● Auxiliary heat pump control

### • External heater output

Operation	Condition
Heater on	Heater is on as shown in following diagram of heating temperature.
Heater off	<ul style="list-style-type: none"> <li>• Heater is off as shown in following diagram of heating temperature.</li> <li>• Other than heating mode</li> <li>• Error occurred</li> <li>• Forced thermostat off</li> </ul>

- Temperature of heater on (Thon): Set temperature (Ts) - 0.9 °F (- 0.5 °C)
- Temperature of heater off: Set temperature (Ts) + 0.9 °F (+ 0.5 °C)

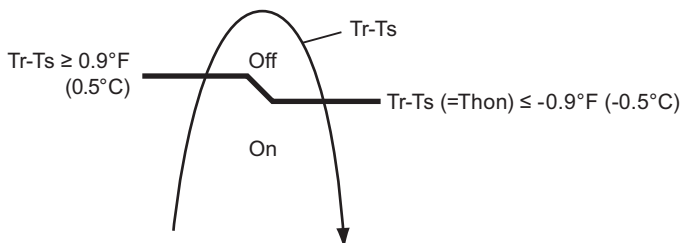

Tr: Room temperature  
Ts: Set temperature  
Thon: Heater on temperature

### • Auxiliary heat pump On/Off

- Temperature of heater on (Thon): Adjustable by function number 62 (Operating temperature switching of heat pump).
- All control temperatures will shift by adjusting “Thon”.

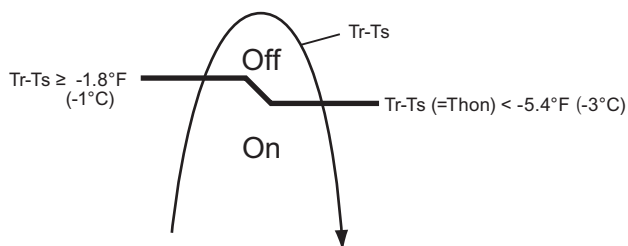

Tr: Room temperature  
Ts: Set temperature  
Thon: Heater on temperature

# ● Auxiliary heat pump control by outdoor temperature 1

## • External heater output

Operation	Condition
Heater on	Heater is on as shown in following diagram of heating temperature.
Heater off	<ul style="list-style-type: none"> <li>• Heater is off as shown in following diagram of heating temperature.</li> <li>• Other than heating mode</li> <li>• Error occurred</li> <li>• Forced thermostat off</li> </ul>

- Temperature of heater on (Thon): Set temperature (Ts) - 0.9 °F (- 0.5 °C)
- Temperature of heater off: Set temperature (Ts) + 0.9 °F (+ 0.5 °C)

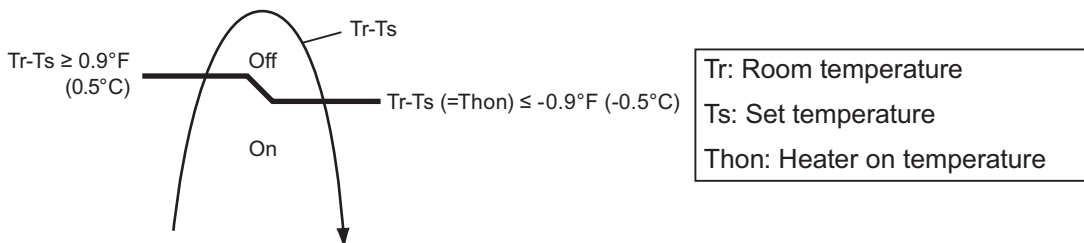

## • Auxiliary heat pump On/Off

- Temperature of heater on (Thon): Adjustable by function number 62 (Operating temperature switching of heat pump).
- All control temperatures will shift by adjusting “Thon”.

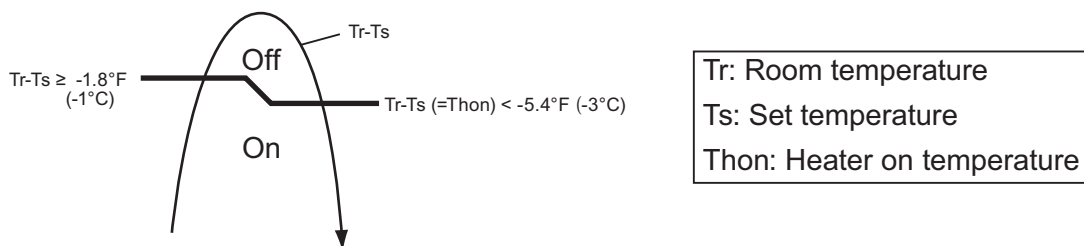

## • Outdoor temperature zone

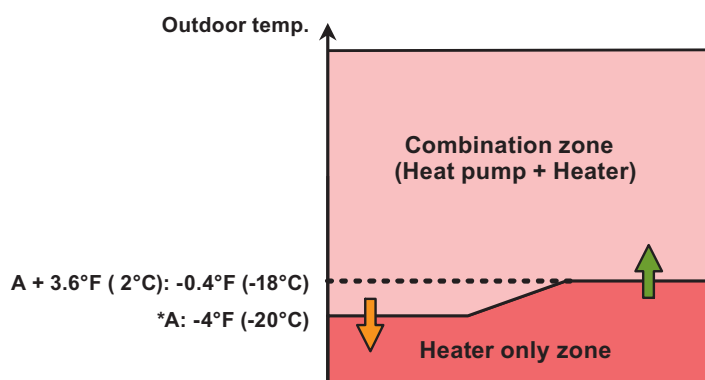

\*: Adjustable by function setting 66

• Operation status

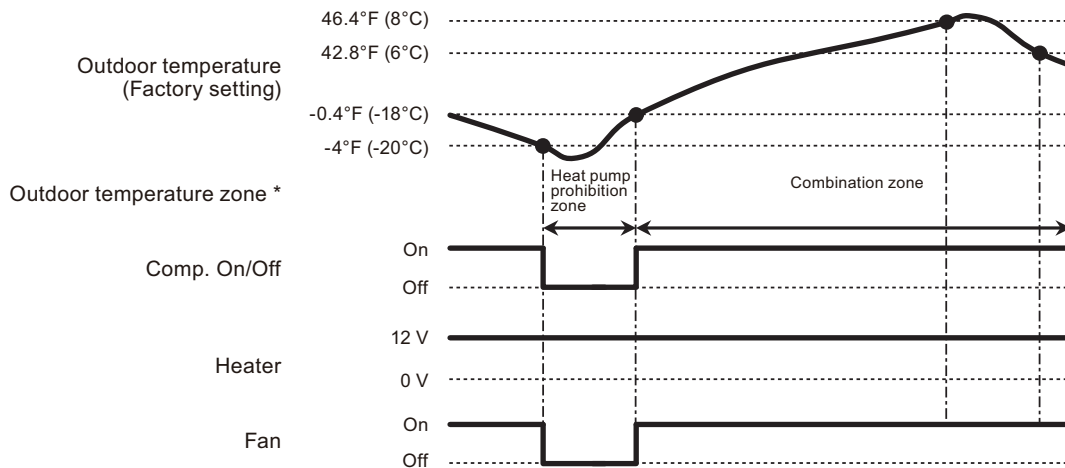

\* The outdoor temperature zone transition from one to another will stay in that zone for minimum of 30 min.

**NOTE:** In following operations, compressor will be on in heat pump prohibition zone.

- Other than heating
- Test run

## ● Auxiliary heat pump control by outdoor temperature 2

### • External heater output

Operation	Condition
Heater on	Heater is on as shown in following diagram of heating temperature.
Heater off	<ul style="list-style-type: none"> <li>• Heater is off as shown in following diagram of heating temperature.</li> <li>• Other than heating mode</li> <li>• Error occurred</li> <li>• Forced thermostat off</li> </ul>

- Temperature of heater on (Thon): Set temperature (Ts) - 0.9 °F (- 0.5 °C)
- Temperature of heater off: Set temperature (Ts) + 0.9 °F (+ 0.5 °C)

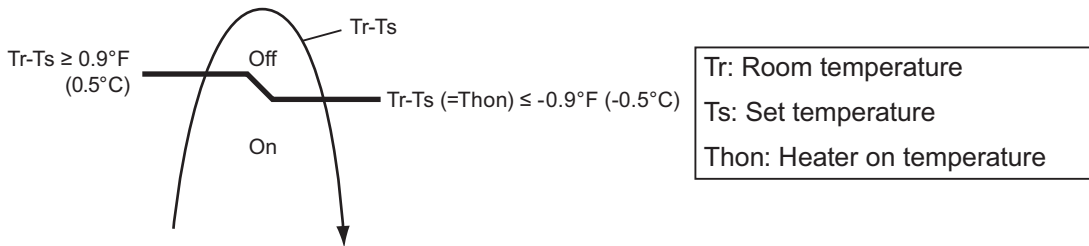

### • Auxiliary heat pump On/Off

- Temperature of heater on (Thon): Adjustable by function number 62 (Operating temperature switching of heat pump).
- All control temperatures will shift by adjusting “Thon”.

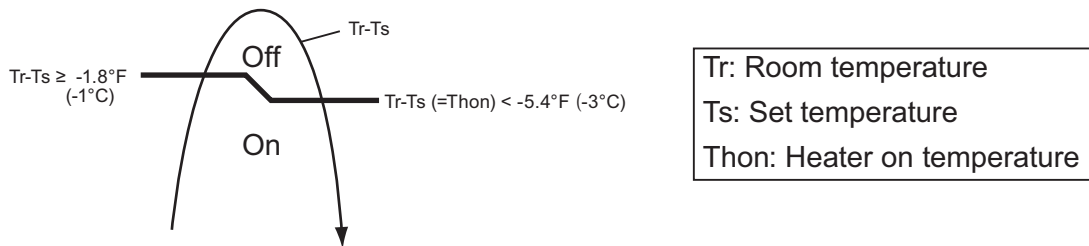

### • Outdoor temperature zone

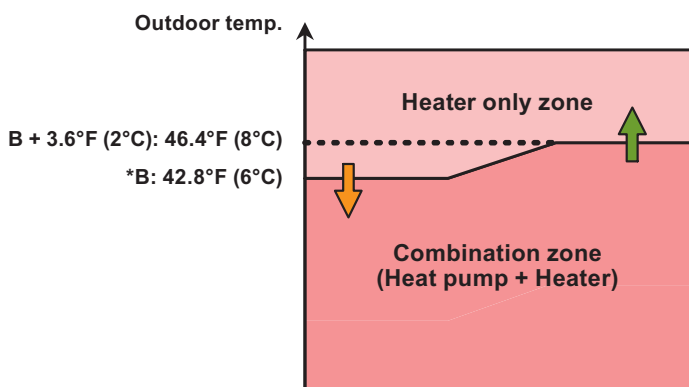

\*: Adjustable by function setting 67



• Operation status

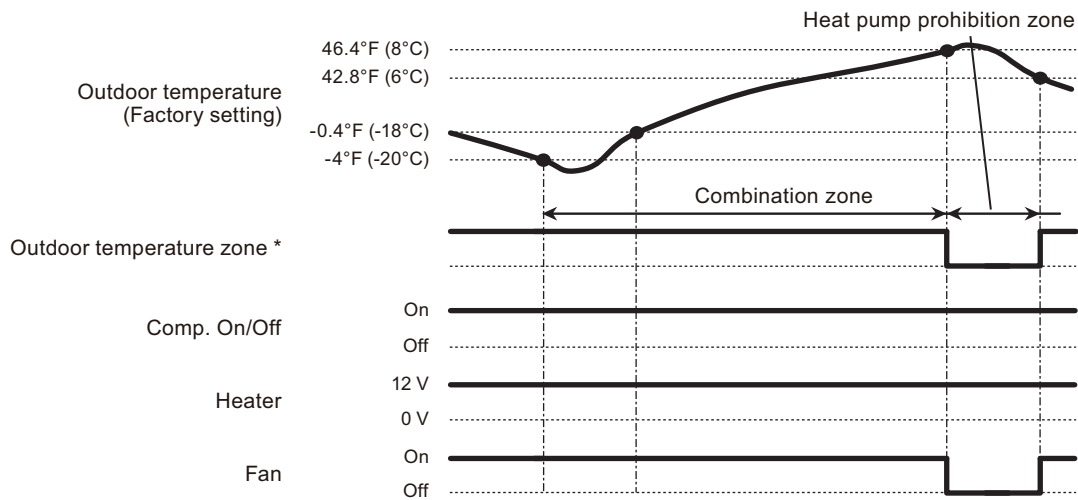

\* The outdoor temperature zone transition from one to another will stay in that zone for minimum of 30 min.

**NOTE:** In following operations, compressor will be on in heat pump prohibition zone.

- Other than heating
- Test run

# ● Auxiliary heat pump control by outdoor temperature 3

## • External heater output

Operation	Condition
Heater on	Heater is on as shown in following diagram of heating temperature.
Heater off	<ul style="list-style-type: none"> <li>• Heater is off as shown in following diagram of heating temperature.</li> <li>• Other than heating mode</li> <li>• Error occurred</li> <li>• Forced thermostat off</li> </ul>

- Temperature of heater on (Thon): Set temperature (Ts) - 0.9 °F (- 0.5 °C)
- Temperature of heater off: Set temperature (Ts) + 0.9 °F (+ 0.5 °C)

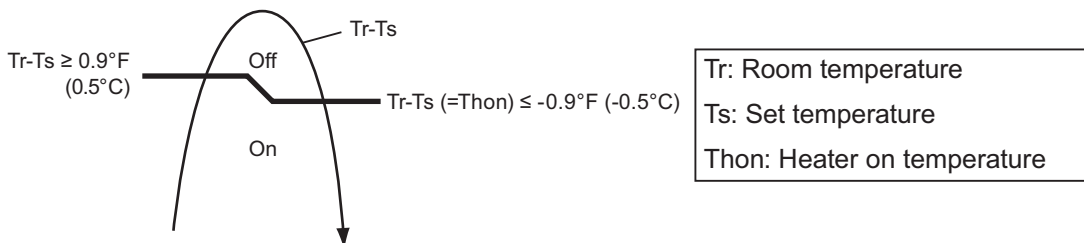

## • Auxiliary heat pump On/Off

- Temperature of heater on (Thon): Adjustable by function number 62 (Operating temperature switching of heat pump).
- All control temperatures will shift by adjusting “Thon”.

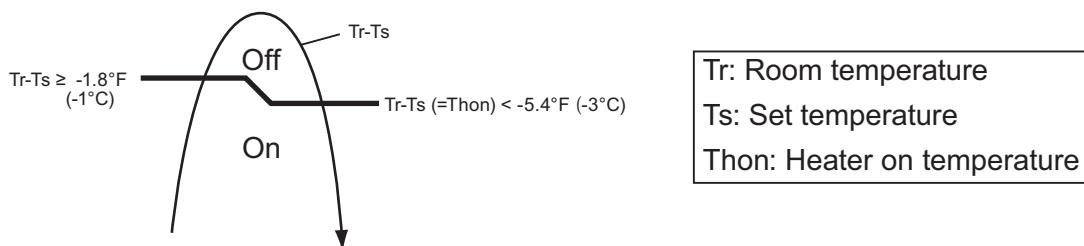

## • Outdoor temperature zone

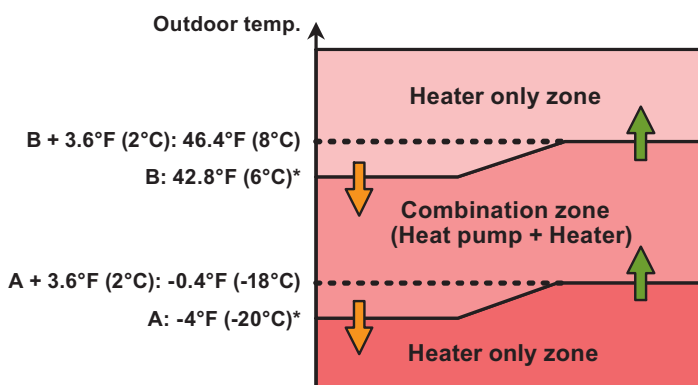

\*: Adjustable by function setting 66 and 67

- Operation status

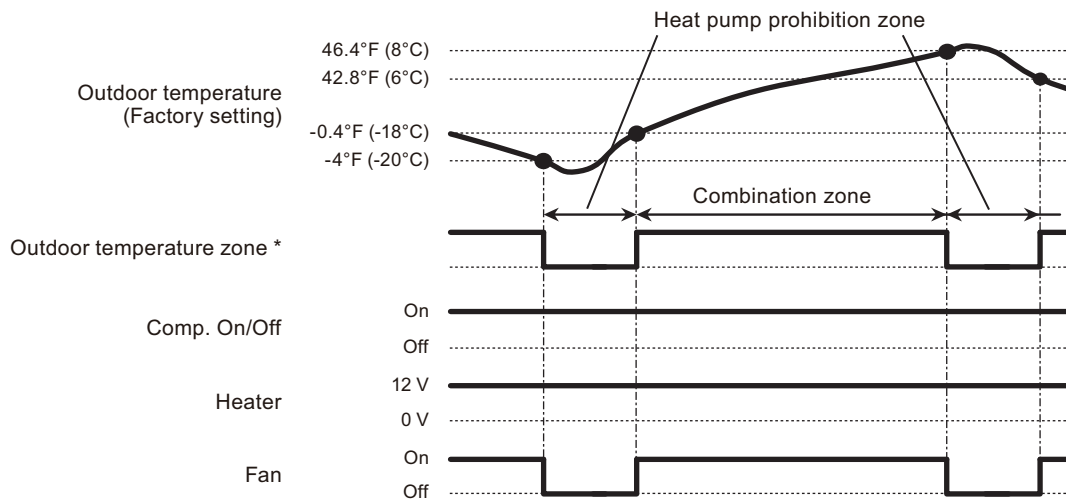

\* The outdoor temperature zone transition from one to another will stay in that zone for minimum of 30 min.

**NOTE:** In following operations, compressor will be on in heat pump prohibition zone.

- Other than heating
- Test run

## ■ Heating thermostat on for humidifier

Situation	Indoor unit				
	Mode	Function setting	Rotary SW	External output	
		Heating thermostat on no. 60		Heating thermostat on	Indoor unit fan operation status
Example of individual connection	5	60-05	7	CN47	Not used
	6	60-06	8	CN312	
	7	60-07	9	CN311	
	8	60-08	A	CN310	

- Example of individual connection

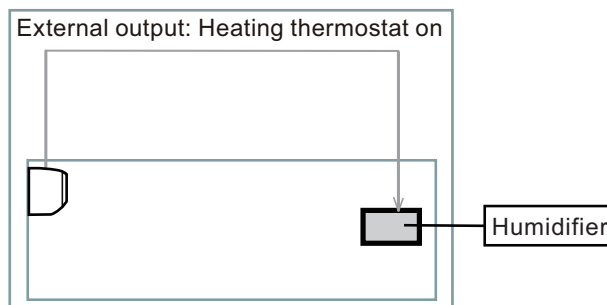

- Operation status

The heating thermostat output for CNB01 (1-2 or 1-3 or 1- or 1-5) will be on when comp on or external heater on.

The heating thermostat output will be off when comp off and external heater off.

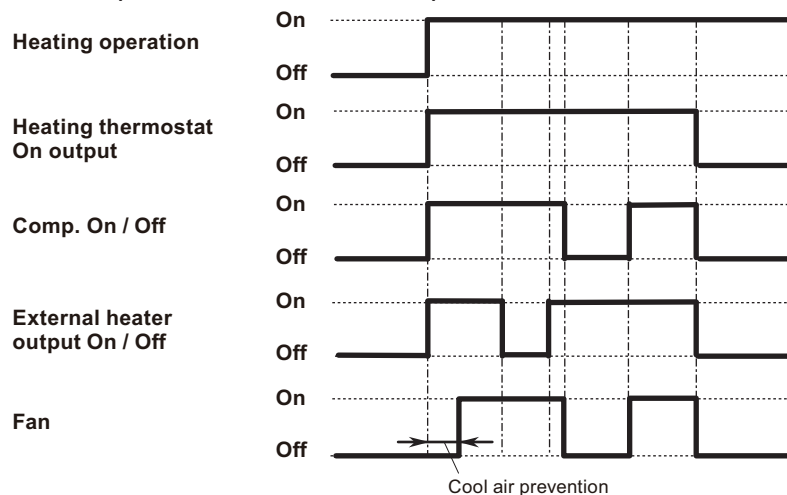

## 9. Group connection

**NOTE:** Group control cannot be used together with Wireless LAN adapter.

### Installation procedure for group control system:

A number of indoor units can be operated at the same time using a single remote controller.

**NOTE:** When different type of indoor units (such as wall-mounted type and cassette type, cassette type and duct type, or other combinations) are connected using group control system, some functions may no longer be available.

1. Connect up to 16 indoor units in a system.

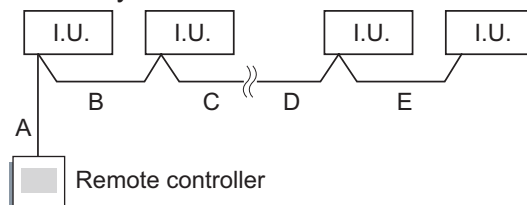

A, B, C, D, E: Remote controller cable	
Wiring length limitation	$A + B + C + D + E \leq 546.8 \text{ yd (500 m)}$

#### Example of wiring method

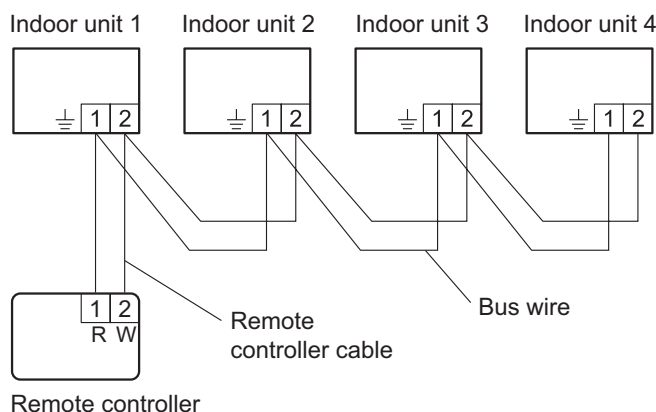

2. Automatic address setting

After the remote controller connection in the system, the automatic address setting runs in the initial starting up. Do not change the remote controller address for the indoor unit.

# 10. Remote controller

## 10-1. Wireless remote controller

### Overview

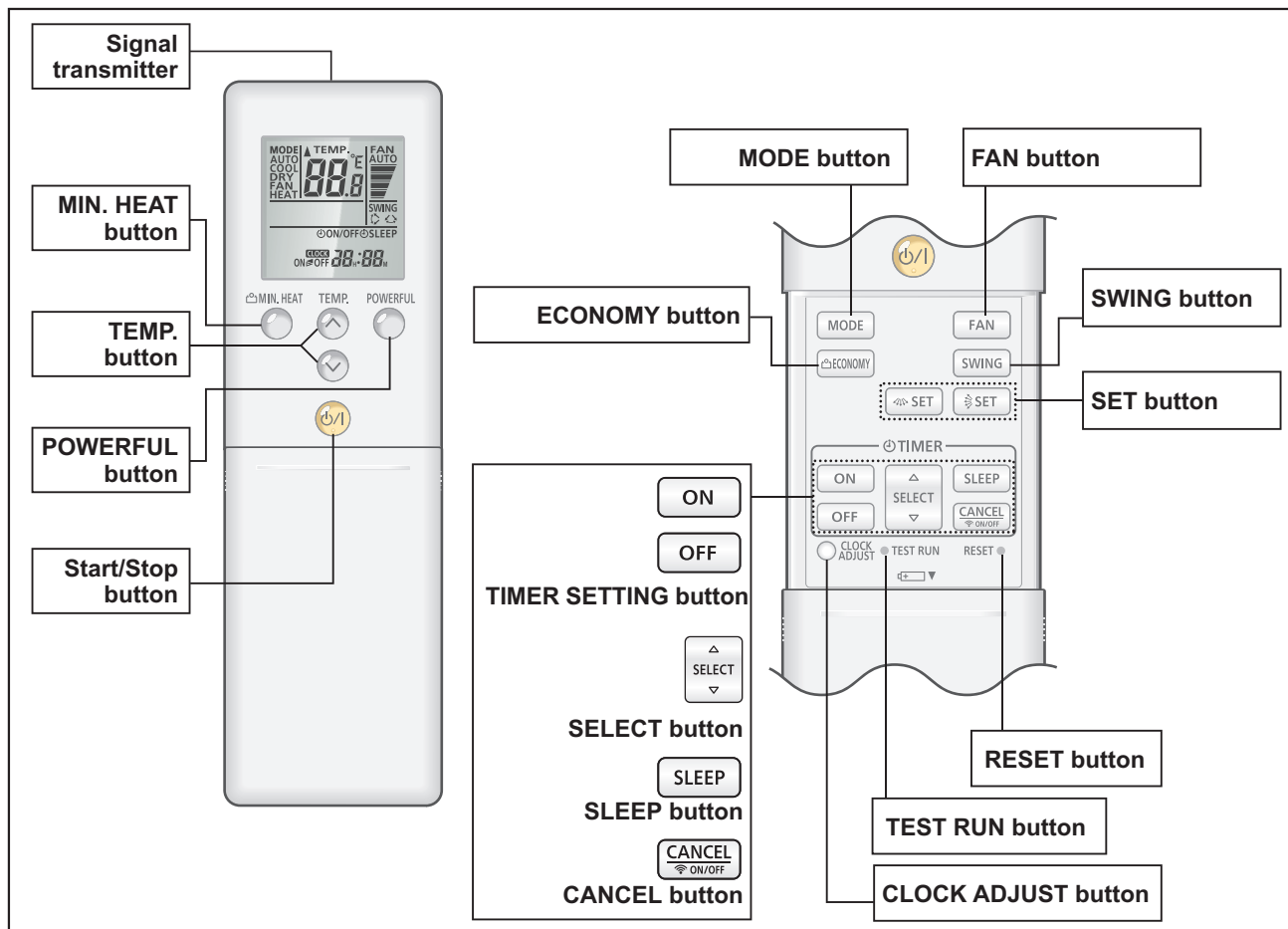

**NOTE:** Functions may differ by type of the indoor unit. For details, refer to the operation manual.

### Display panel

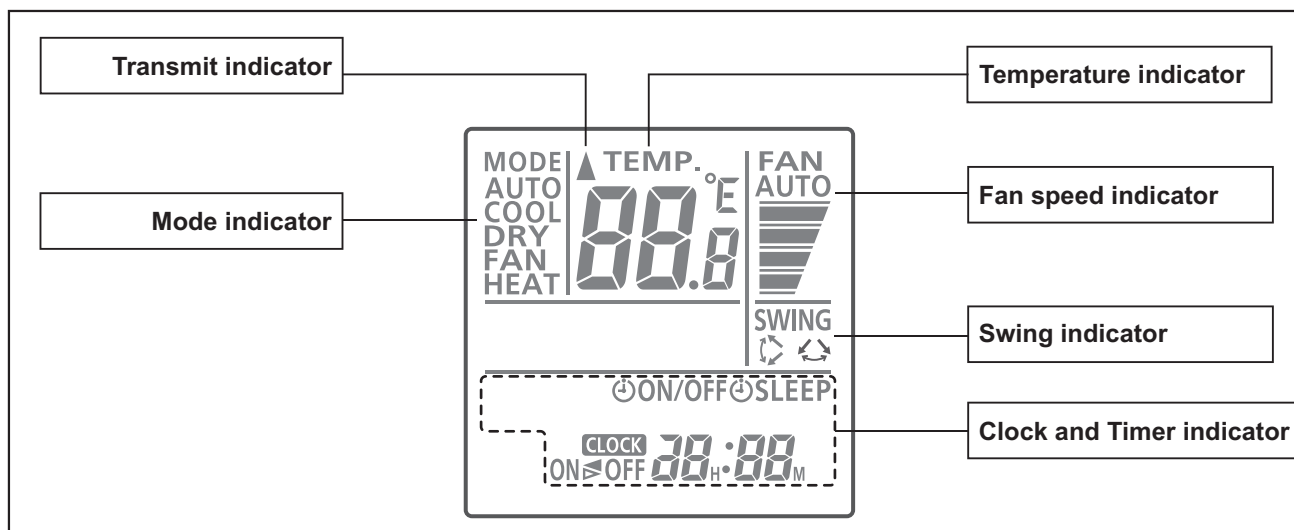

To facilitate explanation, the accompanying illustration has been drawn to show all possible indicators; in actual operation, however, the display will only show those indicators appropriate to the current operation.

# ■ Specifications

## ● Controller

Unit: in (mm)

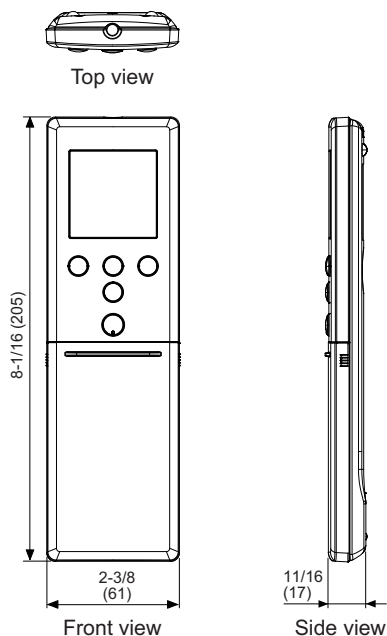

Size (H × W × D)	in (mm)	8-1/16 × 2-3/8 × 11/16 (205 × 61 × 17)
Weight	oz (g)	4.4 (124) (without batteries)

## ● Holder

Unit: in (mm)

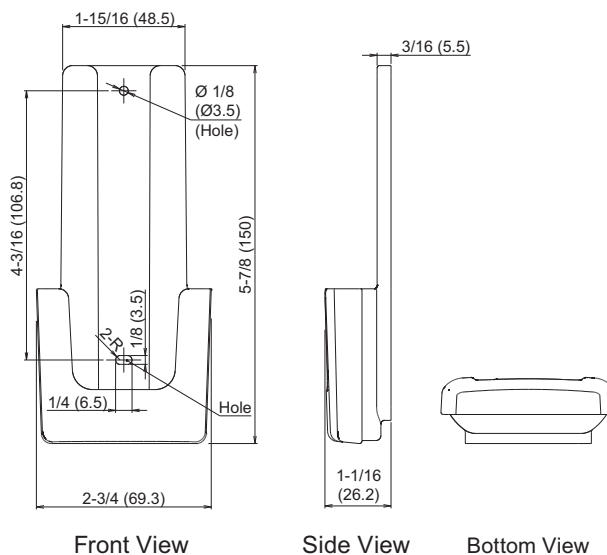

Size (H × W × D)	in (mm)	5-7/8 × 2-3/4 × 1-1/16 (150 × 69.3 × 26.2)
Weight	oz (g)	1 (27)

## 11. Function settings

To adjust the functions of this product according to the installation environment, various types of function settings are available.

**NOTE:** Incorrect settings can cause a product malfunction.

### 11-1. Function settings by using remote controller

Some function settings can be changed on the remote controller. After confirming the setting procedure and the content of each function setting, select appropriate functions for your installation environment.

#### ■ Setting procedure by using wireless remote controller

The function number and the associated setting value are displayed on the LCD of the remote controller. Follow the instructions written in the local setup procedure supplied with the remote controller, and select appropriate setting according to the installation environment.

**Before connecting the power supply of the indoor unit, reconfirm following items:**

- Cover for the electrical enclosure on the outdoor unit is in place.
- There is no wiring mistake.
- Piping air tight test and vacuuming have been performed firmly.
- All the necessary wiring work for outdoor unit has been finished.

After reconfirming the items listed above, connect the power supply of the indoor unit.

#### NOTES:

- Settings will not be changed if invalid numbers or setting values are selected.
- When optional wired remote controller is used, refer to the installation manual enclosed with the remote controller.

#### Entering function setting mode:

While pressing the POWERFUL button and TEMP. (^) button simultaneously, press the RESET button to enter the function setting mode.

#### Selecting the function number and setting value:

1. Press the MIN. HEAT button. TEMP. (^) (v) buttons to select the function number. Press the MIN. HEAT button to switch between the left and right digits.
2. Press the POWERFUL button to proceed to value setting. To return the function number selection, press the POWERFUL button again.
3. Press the TEMP. (^) (v) buttons to select the setting value. To switch between the left and right digits, press the MIN. HEAT button.
4. Press the MODE button once. Confirm that you hear the beep sound.
5. Press the START/STOP button to fix the function setting. Confirm that you hear the beep sound.
6. Press the RESET button to end the function setting mode.
7. After completing the function setting, be sure to disconnect the power supply and then reconnect it.

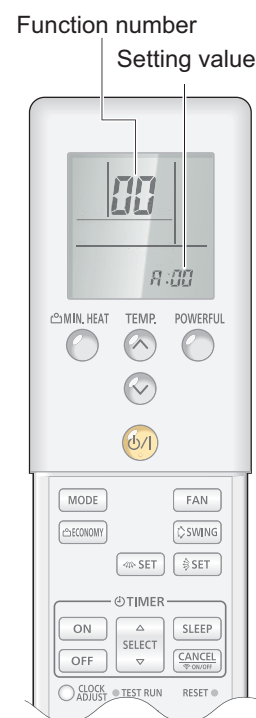





#### ⚠ CAUTION

After disconnecting the power supply, wait 30 seconds or more before reconnecting it. The function setting will not become active unless the power supply is disconnected and then reconnected.



**NOTES:**

- The air conditioner custom code is set to  prior to shipment.
- If you do not know the air conditioner custom code setting, try each of the custom codes ( →   
→  → ) until you find the code that operates the air conditioner.

## ■ Contents of function setting

Each function setting listed in this section is adjustable in accordance with the installation environment.

**NOTE:** Setting will not be changed if invalid numbers or setting values are selected.

### ● Function setting list

	Function no.	Functions
1)	11	Filter sign
2)	30/31	Room temperature control for indoor unit sensor
3)	35/36	Room temperature control for wired remote controller sensor
4)	40	Auto restart
5)	42	Room temperature sensor switching
6)	44	Remote controller custom code
7)	46	External input control
8)	48	Room temperature sensor switching (Aux.)
9)	49	Indoor unit fan control for energy saving for cooling
10)	60	Switching functions for external output terminal
11)	61	Control switching of external heaters
12)	62	Operating temperature switching of external heaters
13)	66	Outdoor temperature zone boundary temperature A
14)	67	Outdoor temperature zone boundary temperature B
15)	71	Standby time for auxiliary equipment operation
16)	72	Heat pump backup setting
17)	73	Emergency heat for external output terminal
18)	94	Fixed operation mode switching
19)	95	Heat insulation condition (building insulation)
20)	96	Special cooling operation

#### 1) Filter sign

Select appropriate intervals for displaying the filter sign on the indoor unit according to the estimated amount of dust in the air of the room.

If the indication is not required, select "No indication" (03).

Function number	Setting value	Setting description	Factory setting
11	00	Standard (400 hours)	
	01	Long interval (1,000 hours)	
	02	Short interval (200 hours)	
	03	No indication	◆

## 2) Room temperature control for indoor unit sensor

**NOTE:** Before performing this setting, refer to Function 95.

Depending on the installed environment, correction of the room temperature sensor may be required. Select the appropriate control setting according to the installed environment.

The temperature of the room temperature sensor is corrected as follows:

Corrected temp. = Temp. of the room temp. sensor - Correction temp. value

Example of correction:

When the temperature of the room temp. sensor is 78°F and the setting value is "03" (-2°F), the corrected temp. will be 80°F (78°F - [-2°F]).

The temperature correction values show the difference from the Standard setting "00" (manufacturer's recommended value).

\*When Function 95-01 (High insulation) is set, the Standard setting "00" will be the same as "No correction 0.0 °F (0.0 °C)" (01).

Function number		Setting value	Setting description	Factory setting	
30 (For cooling)	31 (For heating)	00	Standard setting*	◆	
		01	No correction 0.0 °F (0.0 °C)		
		02	-1 °F (-0.5 °C)	More cooling Less heating	
		03	-2 °F (-1.0 °C)		
		04	-3 °F (-1.5 °C)		
		05	-4 °F (-2.0 °C)		
		06	-5 °F (-2.5 °C)		
		07	-6 °F (-3.0 °C)		
		08	-7 °F (-3.5 °C)		
		09	-8 °F (-4.0 °C)		
		10	+1 °F (+0.5 °C)	Less cooling More heating	
		11	+2 °F (+1.0 °C)		
		12	+3 °F (+1.5 °C)		
		13	+4 °F (+2.0 °C)		
		14	+5 °F (+2.5 °C)		
		15	+6 °F (+3.0 °C)		
		16	+7 °F (+3.5 °C)		
17	+8 °F (+4.0 °C)				

### 3) Room temperature control for wired remote controller sensor

**NOTE:** Before performing this setting, refer to Function 95.

Depending on the installed environment, correction of the wire remote temperature sensor may be required. Select the appropriate control setting according to the installed environment.

To change this setting, set Function 42 to "Both" (01).

Ensure that the Thermo Sensor icon is displayed on the remote controller screen.

\*When Function 95-01 (High insulation) is set, the Standard setting "00" will be the same as "No correction 0.0 °C" (01).

Function number		Setting value	Setting description	Factory setting	
35 (For cooling)	36 (For heating)	00	Standard setting*	◆	
		01	No correction 0.0 °F (0.0 °C)		
		02	-1 °F (-0.5 °C)	More cooling Less heating	
		03	-2 °F (-1.0 °C)		
		04	-3 °F (-1.5 °C)		
		05	-4 °F (-2.0 °C)		
		06	-5 °F (-2.5 °C)		
		07	-6 °F (-3.0 °C)		
		08	-7 °F (-3.5 °C)		
		09	-8 °F (-4.0 °C)		
		10	+1 °F (+0.5 °C)	Less cooling More heating	
		11	+2 °F (+1.0 °C)		
		12	+3 °F (+1.5 °C)		
		13	+4 °F (+2.0 °C)		
		14	+5 °F (+2.5 °C)		
		15	+6 °F (+3.0 °C)		
		16	+7 °F (+3.5 °C)		
17	+8 °F (+4.0 °C)				

### 4) Auto restart

Enables or disables automatic restart after a power interruption.

Function number	Setting value	Setting description	Factory setting
40	00	Enable	◆
	01	Disable	

**NOTE:** Auto restart is an emergency function such as for power outage etc. Do not attempt to use this function in normal operation. Be sure to operate the unit by remote controller or external device.

### 5) Room temperature sensor switching

(Only for wired remote controller)

When using the wired remote controller temperature sensor, change the setting to "Both" (01).

Function number	Setting value	Setting description	Factory setting
42	00	Indoor unit	◆
	01	Both	

00: Sensor on the indoor unit is active.

01: Sensors on both indoor unit and wired remote controller are active.

**NOTE:** Remote controller sensor must be turned on by using the remote controller.

**6) Remote controller custom code**

(Only for wireless remote controller)

The indoor unit custom code can be changed. Select the appropriate custom code.

Function number	Setting value	Setting description	Factory setting
44	00	A	◆
	01	B	
	02	C	
	03	D	

**7) External input control**

"Operation/Stop" mode or "Forced stop" mode can be selected.

Function number	Setting value	Setting description	Factory setting
46	00	Operation/Stop mode 1 (R.C. enabled)	◆
	01	(Setting prohibited)	
	02	Forced stop mode	
	03	Operation/Stop mode 2 (R.C. disabled)	

**8) Room temperature sensor switching (Aux.)**

To use the temperature sensor on the wired remote controller only, change the setting to "Wired remote controller" (01).

This function will only work if the function setting 42 is set at "Both" (01).

When the setting value is set to "Both" (00), more suitable control of the room temperature is possible by setting function setting 30 and 31 too.

Function number	Setting value	Setting description	Factory setting
48	00	Both	◆
	01	Wired remote controller	

**9) Indoor unit fan control for energy saving for cooling**

Enables or disables the power-saving function by controlling the indoor unit fan rotation when the outdoor unit is stopped during cooling operation.

Function number	Setting value	Setting description	Factory setting
49	00	Disable	
	01	Enable	
	02	Remote controller	◆

00: When the outdoor unit is stopped, the indoor unit fan operates continuously following the setting on the remote controller.

01: When the outdoor unit is stopped, the indoor unit fan operates intermittently at a very low speed.

02: Enable or disable this function by remote controller setting.

**NOTES:**

- As the factory setting, this setting is initially invalidated.
- Set to "00" or "01" when connecting a remote controller that cannot set the Fan control for energy saving function or connecting a network converter.  
To confirm if the remote controller has this setting, refer to the operating manual of each remote controller.

## 10) Switching functions for external output terminal

Functions of the external output terminal can be switched. For details, refer to “External input and output”.

Function number	Setting value	Setting description	Factory setting
60	00	Operation status	◆
	01—04	Cooling thermostat On	
	05	Heating operation	
	06	Operation/Stop	
	07—08	Cooling thermostat On	
	09	Error status	
	10	Indoor unit fan operation status	
	11	External heater	
	12	Set point attainment status	

## 11) Control switching of external heaters

Sets the control method for external heater to be used.

For details, refer to “External heater output” in Chapter 8-4. ["Details of function"](#) on page 26.

Function number	Setting value	Setting description	Factory setting
61	00	Auxiliary heater control 1	◆
	01	Auxiliary heater control 2	
	02	Heat pump prohibition control	
	03	Auxiliary heater control by outdoor temperature 1	
	04	Auxiliary heater control by outdoor temperature 2	
	05	Auxiliary heater control by outdoor temperature 3	
	06	Auxiliary heat pump control	
	07	Auxiliary heat pump control by outdoor temperature 1	
	08	Auxiliary heat pump control by outdoor temperature 2	
	09	Auxiliary heat pump control by outdoor temperature 3	

## 12) Operating temperature switching of external heaters

Sets the temperature conditions when the external heater is ON.

For details, refer to “External heater output” in Chapter 8-4. ["Details of function"](#) on page 26.

Function number	Setting value	Setting description		Factory setting
		Heater: On	Heater: Off	
62	00	-5.4 °F (-3 °C)	-1.8 °F (-1 °C)	◆
	01	-3.6 °F (-2 °C)	-1.8 °F (-1 °C)	
	02	-3.6 °F (-2 °C)	-1.8 °F (-1 °C)	
	03	-5.4 °F (-3 °C)	-1.8 °F (-1 °C)	
	04	-7.2 °F (-4 °C)	-1.8 °F (-1 °C)	
	05	-9.0 °F (-5 °C)	-1.8 °F (-1 °C)	

**13) Outdoor temperature zone boundary temperature A**

Setting required if changing of the outdoor temperature setting for heat pump prohibition zone is required when auxiliary heater control by outdoor temperature 1 and 2 are performed on the indoor unit. For details, refer to "External heater output" in Chapter 8-4. "[Details of function](#)" on page 26.

Function number	Setting value	Setting description	Factory setting
66	00	-4.0 °F (-20 °C)	◆
	01	-0.4 °F (-18 °C)	
	02	3.2 °F (-16 °C)	
	03	6.8 °F (-14 °C)	
	04	10.4 °F (-12 °C)	
	05	14.0 °F (-10 °C)	
	06	17.6 °F (-8 °C)	
	07	21.2 °F (-6 °C)	
08	24.8 °F (-4 °C)		

**14) Outdoor temperature zone boundary temperature B**

Setting required if changing of the outdoor temperature setting for heat pump only zone is required when auxiliary heater control by outdoor temperature 1 is performed on the indoor unit. For details, refer to "External heater output" in Chapter 8-4. "[Details of function](#)" on page 26.

Function number	Setting value	Setting description	Factory setting
67	00	42.8 °F (6 °C)	◆
	01	14.0 °F (-10 °C)	
	02	17.6 °F (-8 °C)	
	03	21.2 °F (-6 °C)	
	04	24.8 °F (-4 °C)	
	05	28.4 °F (-2 °C)	
	06	32.0 °F (0 °C)	
	07	35.6 °F (2 °C)	
	08	39.2 °F (4 °C)	
	09	42.8 °F (6 °C)	
	10	46.4 °F (8 °C)	
	11	50.0 °F (10 °C)	
	12	53.6 °F (12 °C)	
	13	57.2 °F (14 °C)	
	14	60.8 °F (16 °C)	
15	64.4 °F (18 °C)		

**15) Standby time for auxiliary equipment operation**

Sets the standby time until the auxiliary equipment operation starts during primary equipment operation.

For details, refer to Chapter 8-4. "[Details of function](#)" on page 26.

Function number	Setting value	Setting description	Factory setting
71	00	Disable	◆
	01	1 minute	
	02	2 minutes	
	•	•	
	•	•	
	•	•	
	98	98 minutes	
	99	99 minutes	

**16) Heat pump backup setting**

Enables or disables the heat pump backup instruction from the outdoor unit.

This function will be usable provided that the corresponding outdoor unit is connected.

Function number	Setting value	Setting description	Factory setting
72	00	Disable	◆
	01	Enable	

**17) Emergency heat for external output terminal**

Enables or disables emergency heat input.

Function number	Setting value	Setting description	Factory setting
73	00	Disable	◆
	01	Enable	

**NOTE:** When this function is used, IR receiver unit is necessary.

**18) Fixed operation mode switching**

Sets the operation mode to heat pump, heating only, or cooling only.

Function number	Setting value	Setting description	Factory setting
94	00	Heat pump	◆
	01	Heating only	
	02	Cooling only	

**NOTE:** Do not use "Heating only" mode (01) of Function 94 and "Enabled" (01) of Function 96 simultaneously.

**19) Heat insulation condition (building insulation)**

Heat insulation conditions differ according to the installed environment.

"Standard insulation" (00) allows system to rapidly respond to the cooling or heating load changes.

"High insulation" (01) is when the heat insulation structure of the building is high and does not require system to rapidly respond to cooling or heating load changes.

When "High insulation" (01) is selected:

- Overheating (overcooling) is prevented at the start-up.
- All room-temperature control settings (Function 30, 31, 35, and 36) will reset to "No correction 0.0 °F (0.0 °C)".

Function number	Setting value	Setting description	Factory setting
95	00	Standard insulation	◆
	01	High insulation	

**NOTE:** When changing Function 95, perform this setting before other room-temperature control settings (Function 30, 31, 35, and 36). If Function 95 is not set first, room-temperature control settings (Function 30, 31, 35, and 36) will be reset and you must re-do them again.



**20) Special cooling operation**

Stabilizes the cooling operation when the outdoor temperature is low.

- Operation mode: Fixed at COOL
- Airflow: Fixed at HIGH
- Set temperature: 76°F (24°C) to 88°F (30°C)

Function number	Setting value	Setting description	Factory setting
96	00	Disable	◆
	01	Enable	

**NOTES:**

- Do not enable this function when the Function 94 setting is “Heating only” (01).
- Connect the optional wired remote controller to change the setting value to “Enable” (01).
- Do not use the wireless remote controller after changing the setting value to “Enable” (01).
- If the wired remote controller becomes noncommunicable after setting “Enable” (01), the cooling operation starts automatically.
- If dew condenses on the indoor unit surface after setting “Enable” (01), set the setting value back to “Disable” (00).

## 11-2. Custom code setting for wireless remote controller

To interconnect the air conditioner and the wireless remote controller, assignment of the custom code for the wireless remote controller is required.

**NOTE:** Air conditioner cannot receive a signal if the air conditioner has not been set for the custom code.

When 2 or more air conditioners are installed in a room, and the remote controller is operating an air conditioner other than the one you wish to set, change the custom code of the remote controller to operate only the air conditioner you wish to set. (4 selections possible.)

Confirm the setting of the remote controller custom code and the function setting. If these do not match, the remote controller cannot be used to operate for the air conditioner.

1. Press the START/STOP button until only the clock is displayed on the remote controller display.
2. Press the MODE button for at least 5 seconds to display the current custom code. (Initially set to  $\text{H}$ .)
3. Press the TEMP. ( $\wedge$ ) ( $\vee$ ) buttons to change the custom code between  $\text{H} \rightarrow \text{b} \rightarrow \text{c} \rightarrow \text{d}$ . Match the code on the display to the air conditioner custom code. (Initially set to  $\text{H}$ .)
4. Press the MODE button again to return to the clock display. The custom code will be changed.



### NOTES:

- If no button is pressed within 30 seconds after the custom code is displayed, the system returns to the original clock indicator. In this case, start again from step 1.
- The air conditioner custom code is set to  $\text{H}$  prior to shipment. To change the custom code, contact your retailer.
- If you do not know the assigned code for the air conditioner, try each of the custom code ( $\text{H} \rightarrow \text{b} \rightarrow \text{c} \rightarrow \text{d}$ ) until you find the code which operates the air conditioner.

## 11-3. Switching the temperature unit of remote controller

Displayed temperature unit on the remote controller LCD can be switched between °F (Fahrenheit) and °C (Celsius).





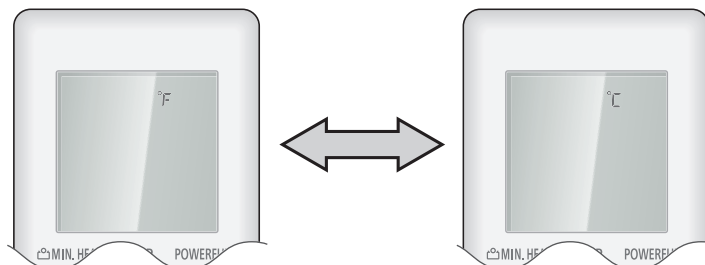

To change temperature unit, do as follows:

1. Press the TEMP. (Up) button (∧) for at least 5 seconds to display the current temperature unit. (Factory setting: °F)
2. Press the TEMP. (∧) (∨) buttons to switch the temperature unit between °F and °C.
3. With either of pressing the START/STOP button or no additional button operation for 30 seconds in step 2., the temperature unit currently selected will be set.





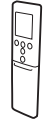
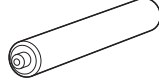

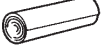
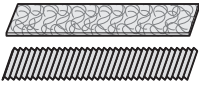
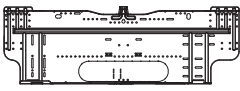

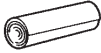
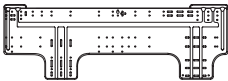

## 12. Accessories

### 12-1. Model: ASUH18LMAS

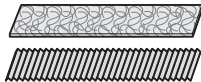

Part name	Exterior	Q'ty	Part name	Exterior	Q'ty
Operating manual		1	Tapping screw (large)		5
Installation manual		1	Tapping screw (small)		2
Remote controller		1	Battery		2
Remote controller holder		1	Filter holder		2
Cloth tape		1	Air cleaning filters		1
Wall hook bracket		1			

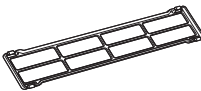
## 12-2. Model: ASUH24LMAS

Part name	Exterior	Q'ty	Part name	Exterior	Q'ty
Operating manual		1	Drain hose insulation		1
Installation manual		1	Cloth tape		1
Wall hook bracket		1	Tapping screw (large)		8
Remote controller		1	Tapping screw (small)		2
Battery		2	Air cleaning filters		1
Remote controller holder		1	Filter holder		2

## 13. Optional parts

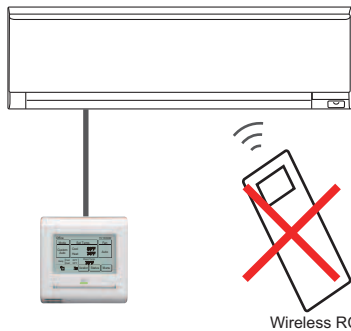

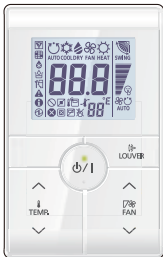



### 13-1. Controllers

Exterior	Part name	Model name	Summary
	Wired remote controller	UTY-RNRUZ*	<p>Easy finger touch operation with LCD panel. Backlit LCD enables easy operation in a dark room. Wire type: Non-polar 2-wire Optional communication kit is necessary for installation.</p> <p><b>NOTE:</b> When this remote controller is connected, wireless remote controller cannot be used.</p>  <p style="text-align: center;">Wireless RC</p>
	Simple remote controller	UTY-RSRY	<p>Compact remote controller concentrates on the basic functions such as Start/Stop, fan control, temperature setting, and operation mode. Wire type: Non-polar 2-wire Optional communication kit is necessary for installation.</p>
	Simple remote controller	UTY-RHRY	<p>Compact remote controller concentrates on the basic functions such as Start/Stop, fan control, and temperature setting. Wire type: Non-polar 2-wire Optional communication kit is necessary for installation.</p>

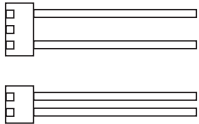
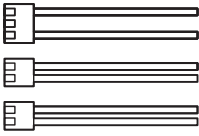
#### NOTES:

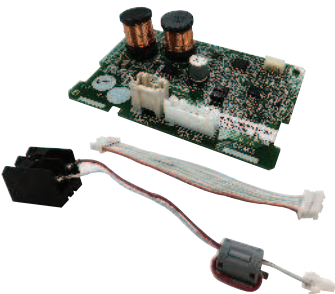
- Available functions may differ by the remote controller. For details, refer to the operation manual.
- When using the group controlling system of the wired remote controller, using Wireless LAN adapter is prohibited.

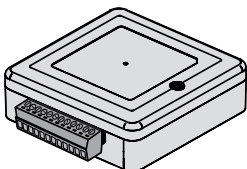
## 13-2. Others

Exterior	Part name	Model name	Summary
	External connect kit	UTY-XWZX	Use to connect with various peripheral devices and air conditioner PCB.
	External connect kit	UTY-XWZXZ5	Required when external device is connected.
	External input and output PCB	UTY-XCSXZ2	Use to connect with external devices and air conditioner PCB. Optional External connect kit is necessary for installation.
	Communication kit	UTY-TWRXZ2	Use to connect Non-polar 2-core wired remote controller.
	Wireless LAN adapter	UTY-TFSXF1	Remotely manage an air conditioning system using mobile devices such as smartphones and tablets. Appropriate application for each region is required to use this option. For details, contact FGL sales company.
	Modbus converter	UTY-VMSX	For connection between indoor unit with UART interface and a Modbus open network.
	Thermostat converter	UTY-TTRX	This converter can control Fujitsu General products using a third-party thermostat controller.
	Network converter	UTY-VTGX	This converter is required when connecting single split system to VRF network system.





# **Part 2. OUTDOOR UNIT**

---

**SINGLE TYPE:**

**AOUH18LMAS1**

**AOUH24LMAS1**

# 1. Specifications

Type			Inverter heat pump	
Model name			AOUH18LMAS1	AOUH24LMAS1
Power supply			208/230 V – 60 Hz	
Power supply intake			Outdoor unit	
Available voltage range			187–253 V	
Starting current			A	
Fan	Airflow rate	Cooling	7.0	8.3
		Heating	1,683 (2,860)	1,936 (3,290)
	Type × Q'ty		1,742 (2,960)	2,187 (3,715)
Motor output		W	Propeller fan × 1 100	
Sound pressure level *1	Cooling	dB (A)	49	52
	Heating		50	54
Heat exchanger type	Dimensions (H × W × D)	in (mm)	Main 1: 29-3/4 × 35-5/8 × 11/16 (756 × 905 × 18.19)	
			Main 2: 29-3/4 × 35-5/8 × 11/16 (756 × 905 × 18.19)	
	Fin pitch	FPI	Main 1: 18 (1.45)	
			Main 2: 18 (1.45)	
	Rows × Stages		Main 1: 1 × 36	
			Main 2: 1 × 36	
Pipe type		Copper		
Fin type	Type (Material)	Aluminum		
	Surface treatment	Blue fin		
Compressor	Type		DC twin rotary	
	Motor output	W	1,360	
Refrigerant	Type		R410A	
	Charge	lb oz	3 lb 15 oz	4 lb 10 oz
		g	1,800	2,100
Refrigerant oil	Type		POE (RB68)	
	Amount	in <sup>3</sup> (cm <sup>3</sup> )	48.8 (800)	
Enclosure	Material		Steel sheet	
	Color		Beige Approximate color of Munsell 10YR 7.5/1.0	
Dimensions (H × W × D)	Net	in (mm)	31 × 37 × 12-5/8 (788 × 940 × 320)	
	Gross		38-1/16 × 40-7/16 × 17-1/2 (966 × 1,027 × 445)	
Weight	Net	lb (kg)	117 (53)	
	Gross		134 (61)	
Connection pipe	Size	Liquid	Ø3/8 (Ø9.52)	
		Gas	Ø5/8 (Ø15.88)	
	Method		Flare	
	Pre-charge length	ft (m)	49 (15)	66 (20)
	Max. length		164 (50)	
Max. height difference	98 (30)			
Drain hose	Material		LDPE	
	Tip diameter	in (mm)	Ø1/2 (Ø13.0) (I.D.), Ø5/8 to 11/16 (Ø16.0 to 16.7) (O.D.)	
Operation range	Cooling	°F (°C)	14 to 115 (-10 to 46)	
	Heating		5 to 75 (-15 to 24)	
<b>NOTES:</b>				
<ul style="list-style-type: none"> <li>Specifications are based on the following conditions: <ul style="list-style-type: none"> <li>Cooling: Indoor temperature of 80 °FDB (26.67 °CDB) / 67 °FWB (19.44 °CWB), and outdoor temperature of 95 °FDB (35 °CDB) / 75 °FWB (23.9 °CWB).</li> <li>Heating: Indoor temperature of 70 °FDB (21.11 °CDB) / 59 °FWB (15 °CWB), and outdoor temperature of 47 °FDB (8.33 °CDB) / 43 °FWB (6.11 °CWB).</li> <li>Pipe length: 25 ft (7.5 m), Height difference: 0 ft (0 m). (Between outdoor unit and indoor unit.)</li> </ul> </li> <li>Protective function might work when using it outside the operation range.</li> <li>*1: Sound pressure level <ul style="list-style-type: none"> <li>Measured values in manufacturer's anechoic chamber.</li> <li>Because of the surrounding sound environment, the sound levels measured in actual installation conditions might be higher than the specified values here.</li> </ul> </li> </ul>				

## 2. Dimensions

### 2-1. Models: AOUH18LMAS1 and AOUH24LMAS1

Unit: in (mm)

OUTDOOR UNIT  
AOUH18-24LMAS1

OUTDOOR UNIT  
AOUH18-24LMAS1

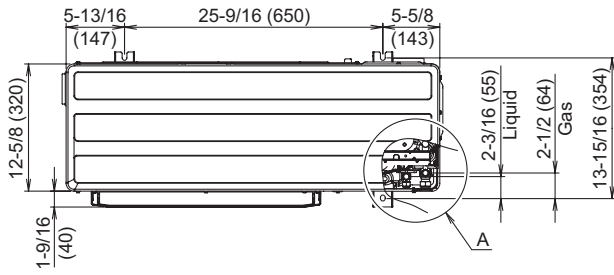

Top view

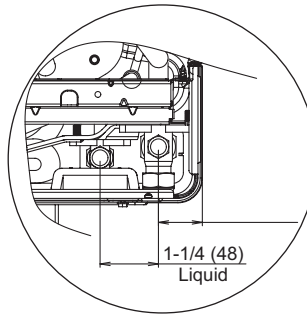

Detail A

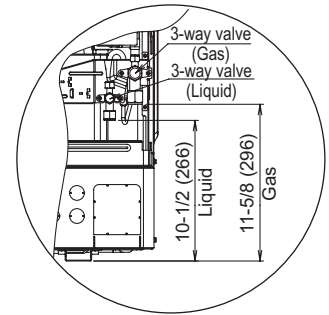

Detail B

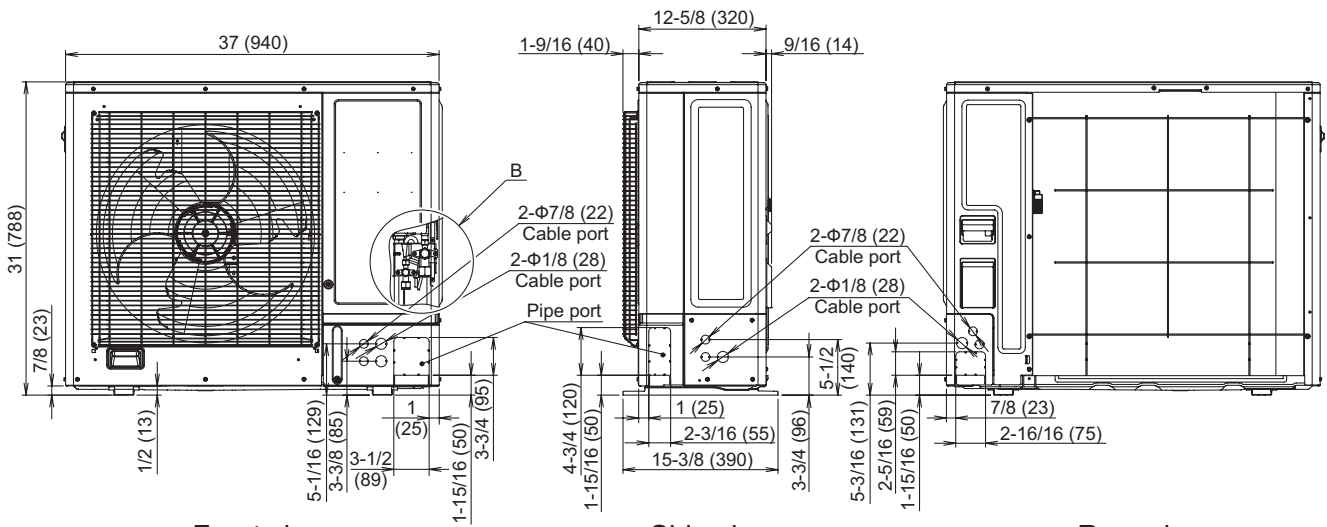

Front view

Side view

Rear view

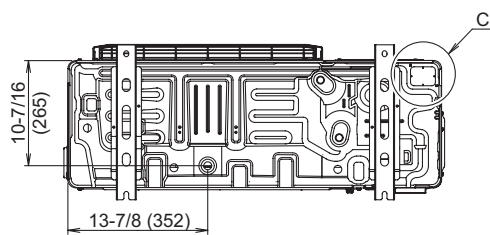

Bottom view

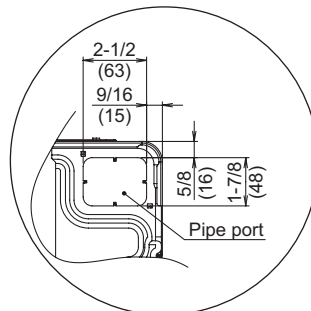

Detail C

## 3. Installation space

### 3-1. Models: AOUH18LMAS1 and AOUH24LMAS1

#### ■ Space requirement

Provide sufficient installation space for product safety.

#### ⚠ CAUTION

Keep the space shown in the installation examples.

If the installation is not performed accordingly, it could cause a short circuit and result in a lack of operating performance.

#### ● Single outdoor unit installation

- When the upper space is open:

Unit: in (mm)

When there are obstacles at the rear only.

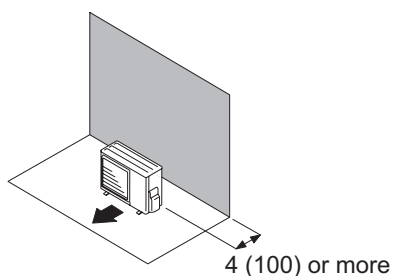

When there are obstacles at the rear and sides.

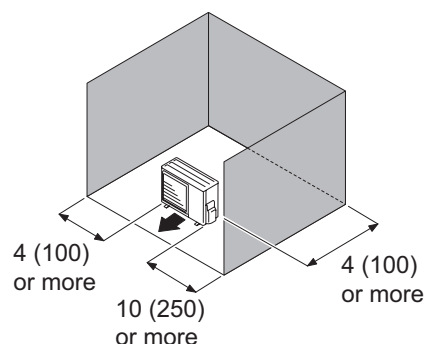

When there are obstacles at the front only.

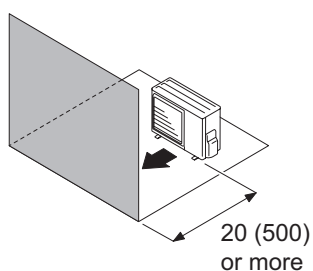

When there are obstacles at the front and rear.

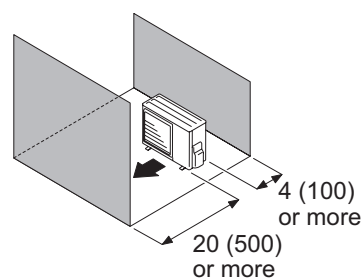

• When an obstruction in the upper space:

Unit: in (mm)

When there are obstacles at the rear and above.

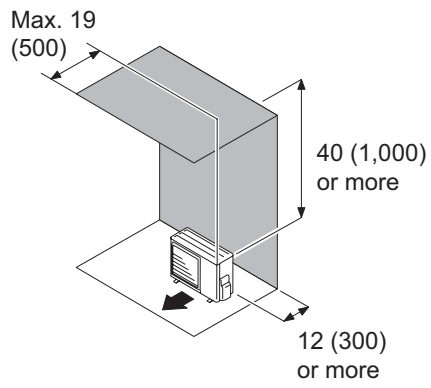

When there are obstacles at the rear, sides, and above.

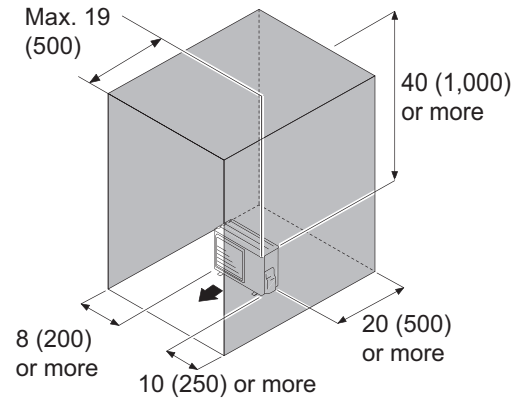

OUTDOOR UNIT  
AOUH18-24LMAS1

OUTDOOR UNIT  
AOUH18-24LMAS1

## ● Multiple outdoor unit installation

- Provide at least 250 mm of space between the outdoor units if multiple units are installed.
  - When routing the piping from the side of an outdoor unit, provide space for piping.
  - No more than 3 units must be installed side by side.
- When 4 units or more are arranged in a line, provide the space as shown in the following example **“When an obstruction in the upper space:”**.

- **When the upper space is open:**

Unit: in (mm)

When there are obstacles at the rear only.

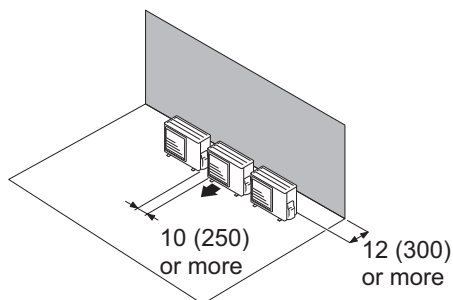

When there are obstacles at the front only.

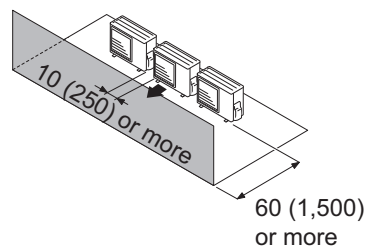

When there are obstacles at the front and rear.

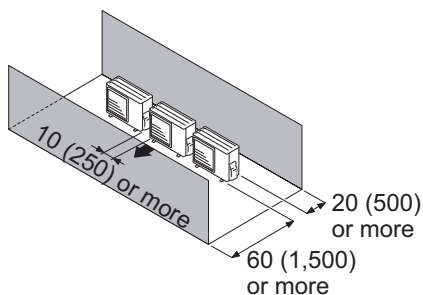

- **When an obstruction in the upper space:**

Unit: in (mm)

When there are obstacles at the rear and above.

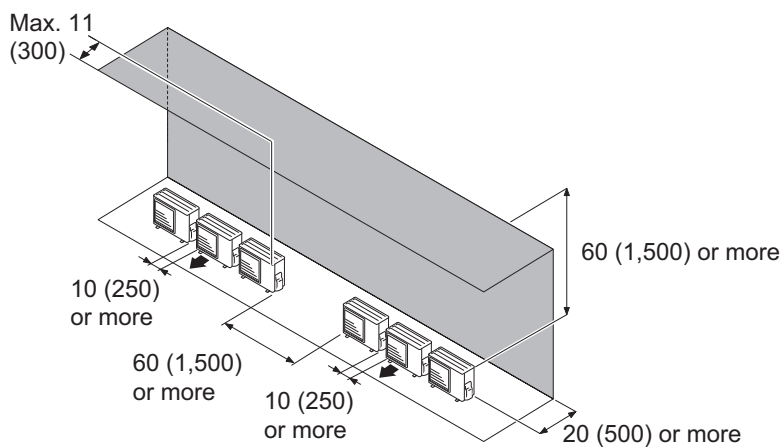

## ● Outdoor unit installation in multi-row

Unit: in (mm)

Single parallel unit arrangement

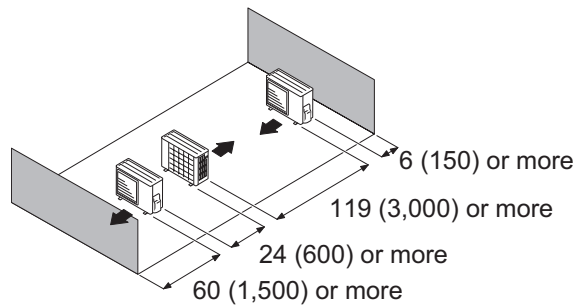

Multiple parallel unit arrangement

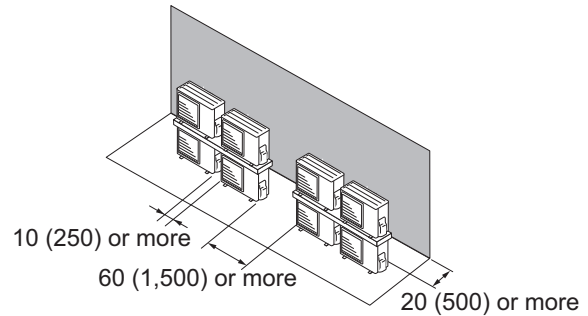
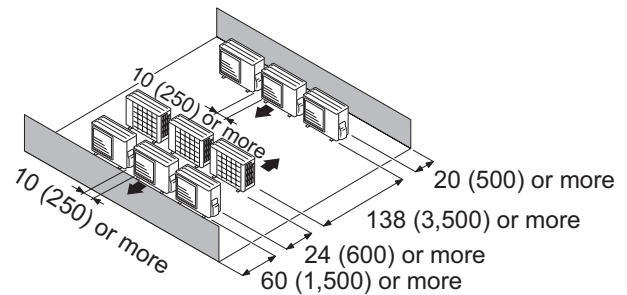

### NOTES:

- If the space is larger than stated above, the condition will be the same as when there is no obstacle.
- Height above the floor level should be 2 in (50 mm) or more.
- When installing the outdoor unit, be sure to open the front and left side to obtain better operation efficiency.

### ⚠ CAUTION

- Do not install the outdoor unit in two-stage where the drain water could freeze. Otherwise the drainage from the upper unit may form ice and cause a malfunction of the lower unit.
- When the outdoor temperature is 32 °F (0 °C) or less, do not use the accessory drain pipe and drain cap. If the drain pipe and drain cap are used, the drain water in the pipe may freeze in extremely cold climate. (For reverse cycle model only.)
- In area with heavy snowfall, if the inlet and outlet of the outdoor unit is blocked with snow, it might become difficult to get warm, and it is likely to cause product malfunction. Construct a canopy and a pedestal, or place the unit on a high stand that is locally installed.

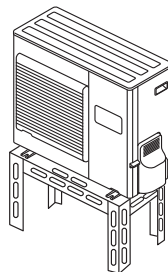

## 4. Refrigerant circuit

### 4-1. Models: AOUH18LMAS1 and AOUH24LMAS1

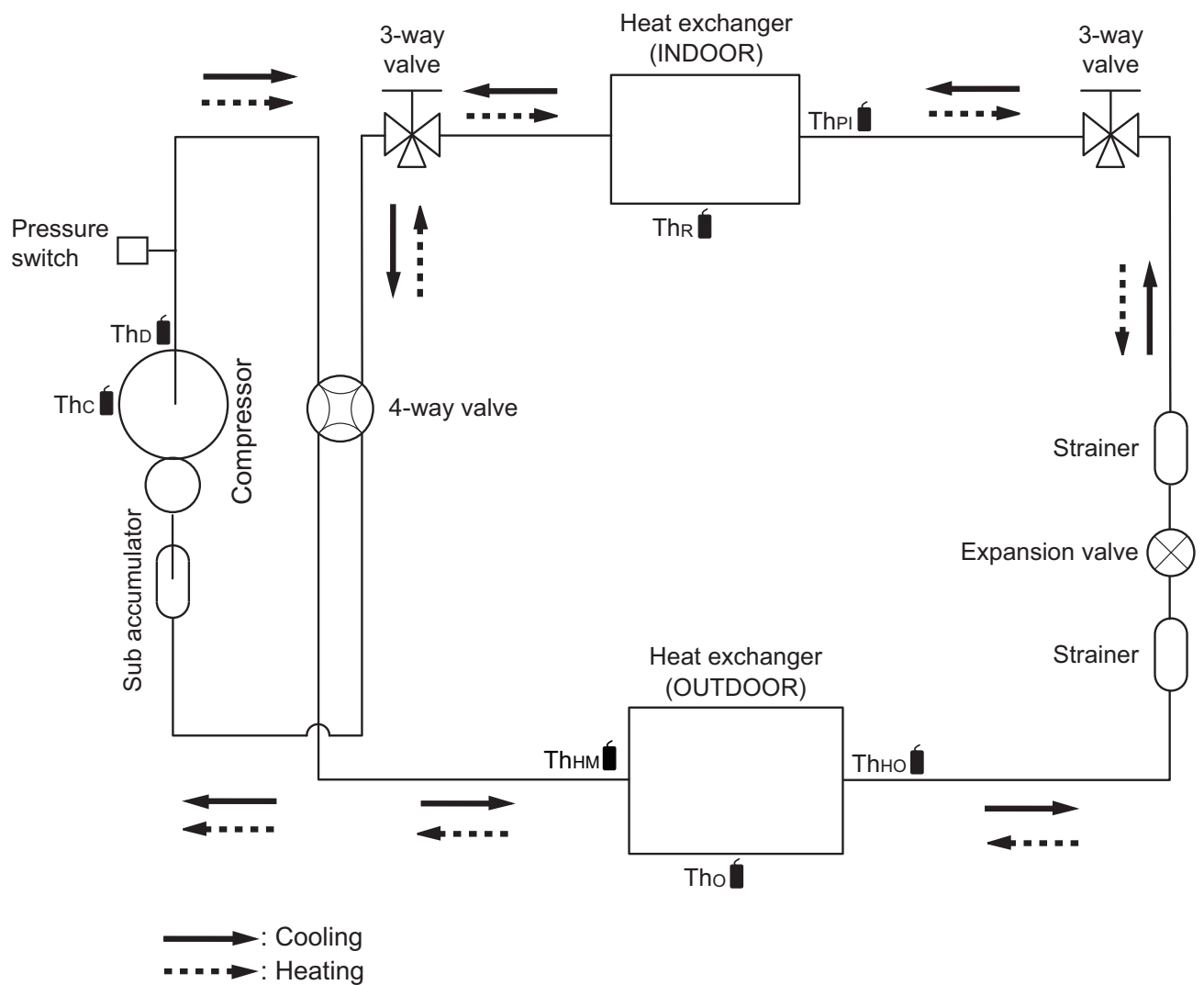

Th<sub>c</sub> : Thermistor (Compressor temperature)

Th<sub>d</sub> : Thermistor (Discharge temperature)

Th<sub>m</sub> : Thermistor (Heat exchanger middle temperature)

Th<sub>o</sub> : Thermistor (Outdoor temperature)

Th<sub>o</sub> : Thermistor (Heat exchanger out temperature)

Th<sub>pi</sub> : Thermistor (Pipe temperature)

Th<sub>r</sub> : Thermistor (Room temperature)



# 5. Wiring diagrams

## 5-1. Models: AOUH18LMAS1 and AOUH24LMAS1

OUTDOOR UNIT  
AOUH18-24LMAS1

OUTDOOR UNIT  
AOUH18-24LMAS1

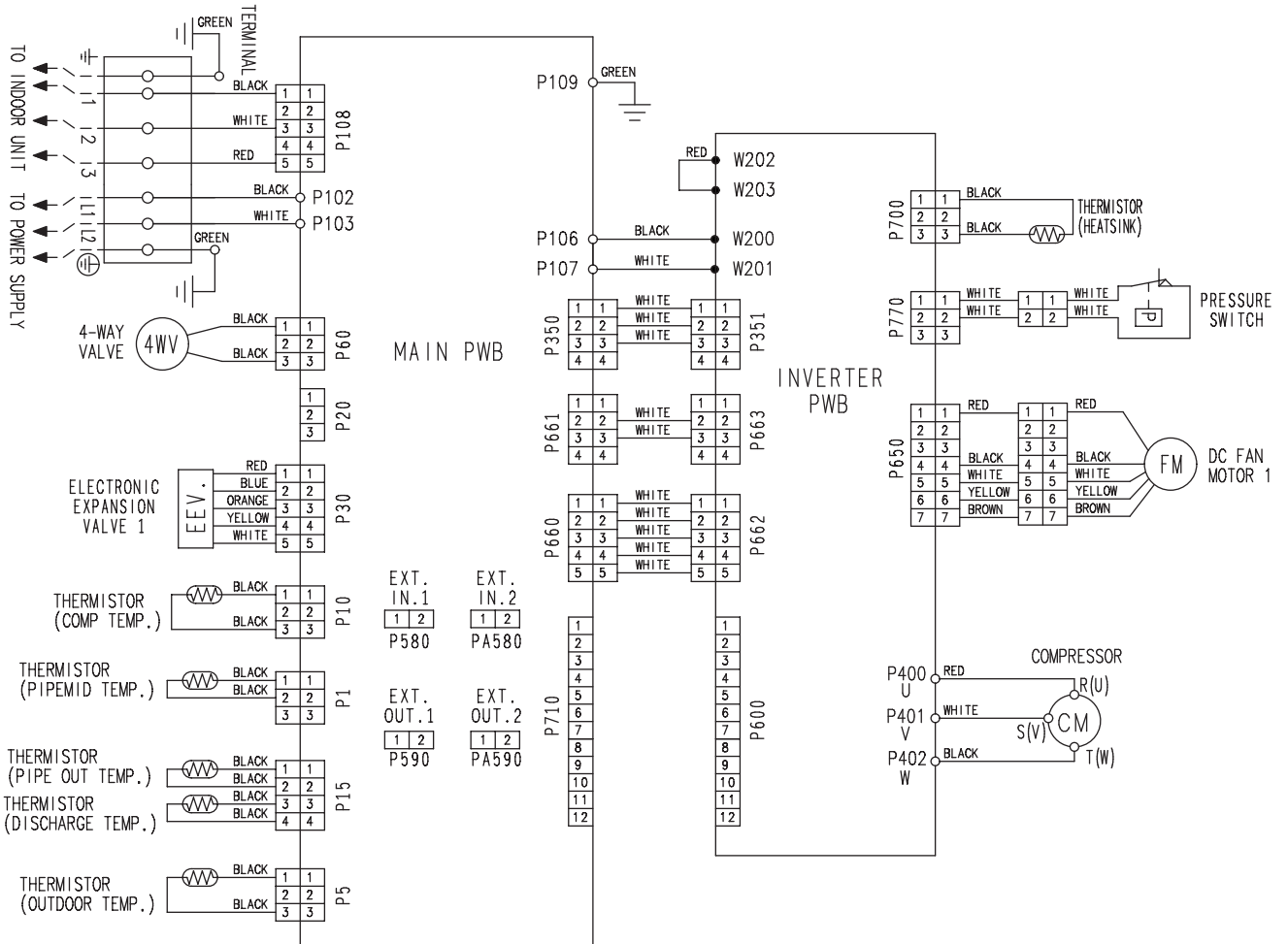

## 6. Capacity compensation rate for pipe length and height difference

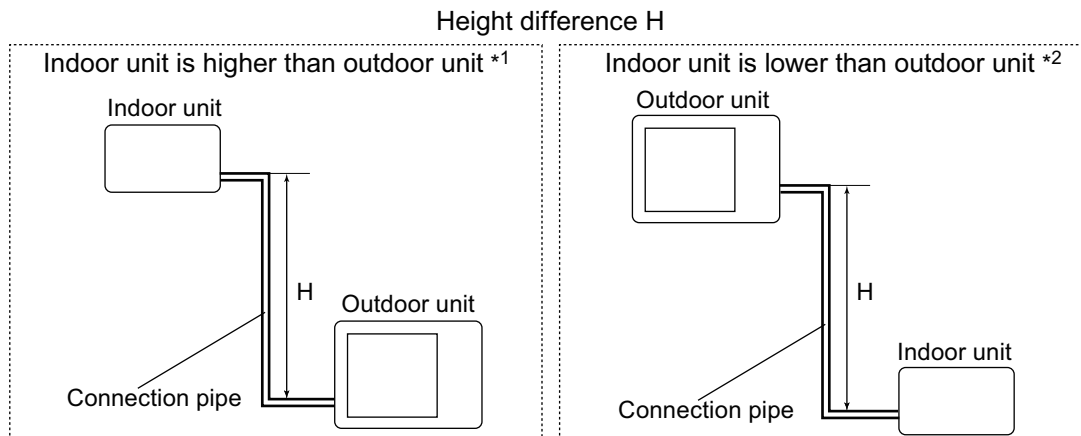

### 6-1. Models: AOUH18LMAS1 and AOUH24LMAS1

**NOTE:** Values mentioned in the table are calculated based on the maximum capacity.

COOLING		Pipe length								
		m	5	7.5	10	20	30	40	50	
		ft	16	24	32	65	98	131	164	
Height difference H	Indoor unit is higher than outdoor unit *1	30	98	-	-	-	-	0.932	0.929	0.924
		20	65	-	-	-	0.945	0.947	0.945	0.940
		10	32	-	-	0.984	0.961	0.963	0.960	0.956
		7.5	24	-	0.988	0.988	0.965	0.967	0.964	0.959
		5	16	0.992	0.992	0.992	0.968	0.971	0.968	0.963
Height difference H	Indoor unit is lower than outdoor unit *2	0	0	0.998	1.000	1.000	0.976	0.979	0.976	0.971
		-5	-16	0.998	1.000	1.000	0.976	0.979	0.976	0.971
		-7.5	-24	-	1.000	1.000	0.976	0.979	0.976	0.971
		-10	-32	-	-	1.000	0.976	0.979	0.976	0.971
		-20	-65	-	-	-	0.976	0.979	0.976	0.971
		-30	-98	-	-	-	-	0.979	0.976	0.971

HEATING		Pipe length								
		m	5	7.5	10	20	30	40	50	
		ft	16	24	32	65	98	131	164	
Height difference H	Indoor unit is higher than outdoor unit *1	30	98	-	-	-	-	0.816	0.756	0.686
		20	65	-	-	-	0.872	0.816	0.756	0.686
		10	32	-	-	0.991	0.872	0.816	0.756	0.686
		7.5	24	-	1.000	0.991	0.872	0.816	0.756	0.686
		5	16	0.986	1.000	0.991	0.872	0.816	0.756	0.686
Height difference H	Indoor unit is lower than outdoor unit *2	0	0	0.986	1.000	0.991	0.872	0.816	0.756	0.686
		-5	-16	0.981	0.995	0.986	0.868	0.812	0.752	0.683
		-7.5	-24	-	0.993	0.983	0.866	0.810	0.750	0.681
		-10	-32	-	-	0.981	0.864	0.808	0.748	0.679
		-20	-65	-	-	-	0.855	0.799	0.740	0.672
		-30	-98	-	-	-	-	0.791	0.733	0.665

## 7. Additional charge calculation

### 7-1. Model: AOUH18LMAS1

Refrigerant type		R410A
Factory charge amount	lb oz	3 lb 15 oz
	g	1,800

#### ■ Refrigerant charge

Total pipe length	ft	49 or less	66	99	131	165 (Max.)	0.43 oz/ft (40 g/m)
	m	15 or less	20	30	40	50 (Max.)	
Additional charge	lb oz	0	7 oz	1 lb 5 oz	2 lb 3 oz	3 lb 1 oz	
	g	0	200	600	1,000	1,400	

### 7-2. Model: AOUH24LMAS1

Refrigerant type		R410A
Factory charge amount	lb oz	4 lb 10 oz
	g	2,100

#### ■ Refrigerant charge

Total pipe length	ft	65 or less	99	131	165 (Max.)	0.43 oz/ft (40 g/m)
	m	20 or less	30	40	50 (Max.)	
Additional charge	lb oz	0	14 oz	1 lb 12 oz	2 lb 10 oz	
	g	0	400	800	1,200	

## 8. Airflow

### 8-1. Model: AOUH18LMAS1

#### ● Cooling

Airflow	
m <sup>3</sup> /h	2,860
l/s	795
CFM	1,683

#### ● Heating

Airflow	
m <sup>3</sup> /h	2,960
l/s	822
CFM	1,742

### 8-2. Model: AOUH24LMAS1

#### ● Cooling

Airflow	
m <sup>3</sup> /h	3,290
l/s	914
CFM	1,936

#### ● Heating

Airflow	
m <sup>3</sup> /h	3,715
l/s	1,032
CFM	2,187

# 9. Operation noise (sound pressure)

## 9-1. Noise level curve

### Model: AOUH18LMAS1

#### Cooling

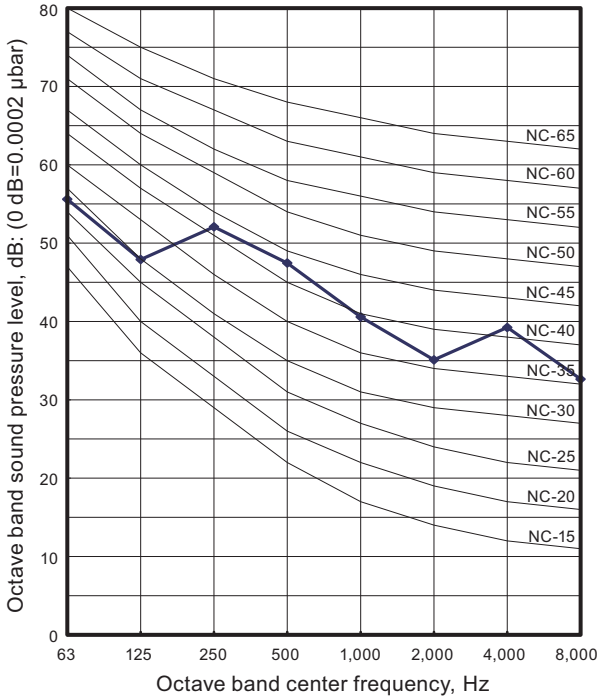

#### Heating

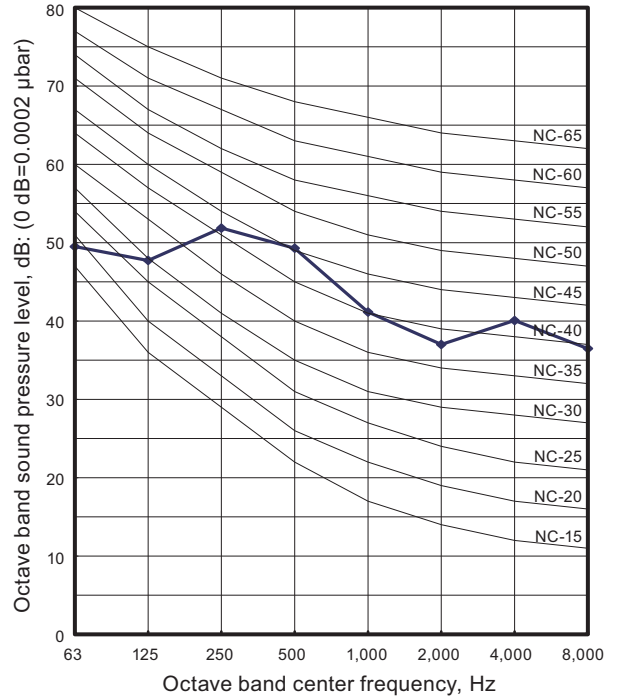

### Model: AOUH24LMAS1

#### Cooling

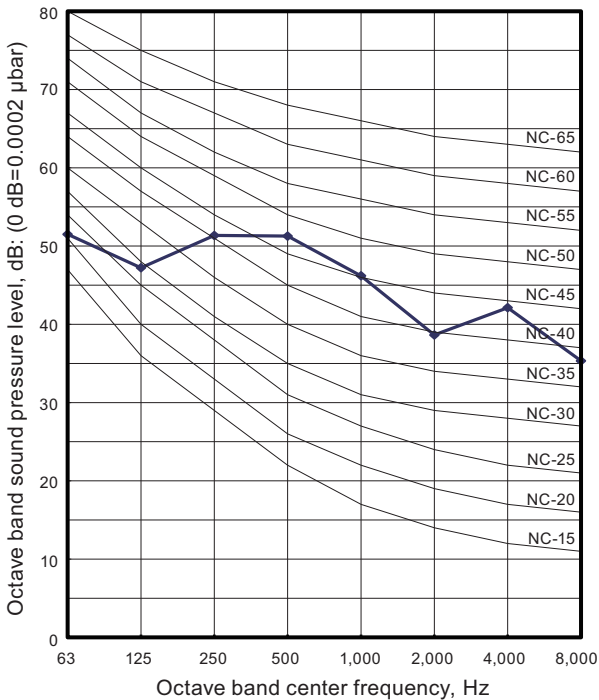

#### Heating

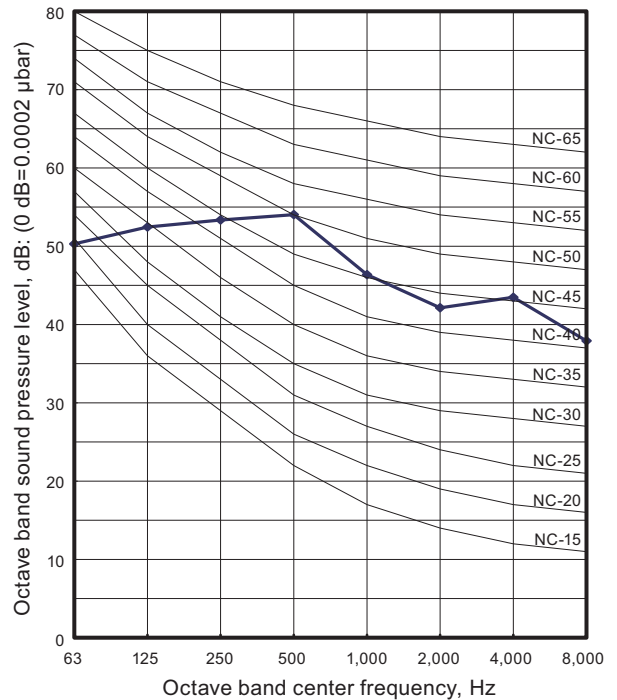

OUTDOOR UNIT  
AOUH18-24LMAS1

OUTDOOR UNIT  
AOUH18-24LMAS1

## 9-2. Sound level check point

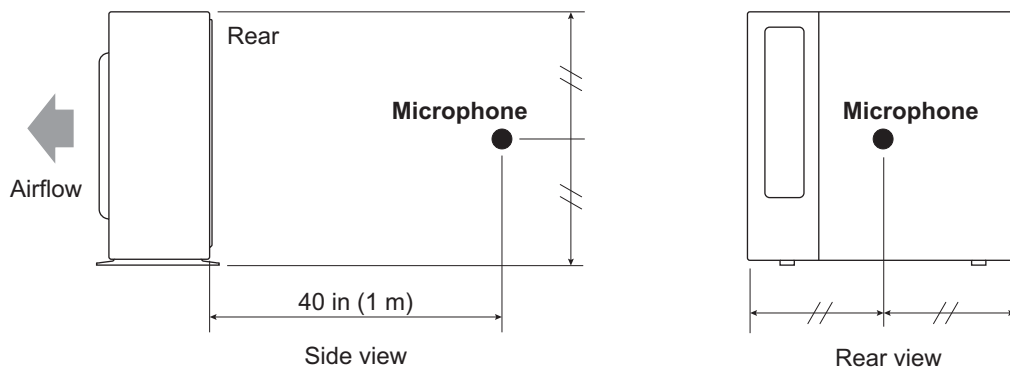

**NOTE:** Detailed shape of the actual outdoor unit might be slightly different from the one illustrated above.

## 10. Electrical characteristics

Model name			AOUH18LMAS1	AOUH24LMAS1	
Power supply	Voltage	V	208/230		
	Frequency	Hz	60		
MCA *1		A	17.1	19.6	
Starting current		A	7.0	8.3	
Wiring spec. *2	MAX. CKT. BKR *3		A		
	Power cable		AWG	14	
	Connection cable *4	Size	AWG	14	
		Limited wiring length	ft (m)	167 (51)	

\*1: Minimum Circuit Ampacity (Calculation based on UL60335-2-40)

\*2: Selected sample based on Japan Electrotechnical Standards and Codes Committee E0005. As the regulations of wire size and circuit breaker differ in each country or region, select appropriate devices complied to the regional standard.

\*3: Maximum Circuit Breaker

\*4: Limit voltage drop to less than 2%. If voltage drop is 2% or more, increase cable conductor size.

# 11. Safety devices

Type of protection	Protection form		Model	
			AOUH18LMAS1	AOUH24LMAS1
Circuit protection	Current fuse (Main PCB)		250 V, 20 A	
			250 V, 3.15 A	
			250 V, 10 A × 2	
Fan motor protection	Thermal protection	Activate	251.6 ±16.2°F (122 ±9°C) Fan motor stop	
		Reset	240.8 <sup>+18.0</sup> <sub>-16.2</sub> °F (116 <sup>+10</sup> <sub>-.9</sub> °C) Fan motor restart	
Compressor protection	Thermal protection program (Compressor temp.)	Activate	226.4°F (108°C) Compressor stop	
		Reset	After 3 minutes, and 176°F (80°C) or less Compressor restart	
	Thermal protection program (Discharge temp.)	Activate	230°F (110°C) Compressor stop	
		Reset	After 7 minutes Compressor restart	



## 12. External input and output

With using external input and output functions, this product can be operated inter-connectedly with an external device.

Connector	Input	Output	Remarks
P580	Low noise mode	—	See external input/output settings for details.
PA580	Peak cut mode	—	
P590	—	Error status	
PA590	—	Compressor status	

### 12-1. External input

With using external input function, on/off status of “Low noise mode” and “Peak cut mode” can be specified by the external signal.

#### ■ Low noise mode

In following condition, the operating noise of the outdoor unit reduces comparing from the one in normal operating condition:

The air conditioner is set to the “Low noise mode” when closing the contact input of a commercial timer or on/off switch to a connector on the control PCB of the outdoor unit.

**NOTE:** Product performance may drop depending on some conditions such as the outdoor temperature.

#### • Circuit diagram example

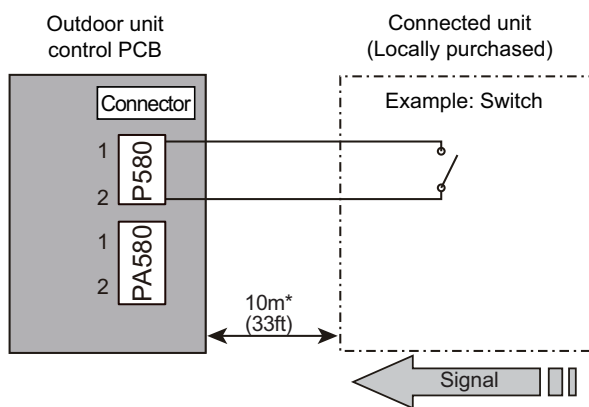

- Contact capacity: DC 24 V or more, 10 mA or more.
- \*: Make the distance from the PCB to the connected unit within 33 ft (10 m).
- Construct a circuit as shown in this figure with using optional parts mentioned below.
- Input signal: On in “Low noise mode”
- Input signal: Off in normal operation
- To set the level of “Low noise mode”, refer to “Low noise mode” in ["Local setting procedure"](#) on page 91.

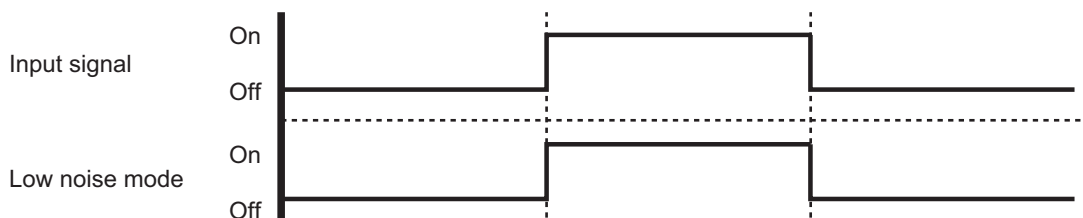

#### • Optional part

Part name	Model name	Exterior
External connect kit	UTY-XWZXZ3	External input wire 

## ■ Peak cut mode

By performing following on-site work, operation that suppresses the current value can be enabled: The air conditioner is set to the “Peak cut mode” when closing the contact input of a commercial timer or on/off switch to a connector on the control PCB of the outdoor unit.

### • Circuit diagram example

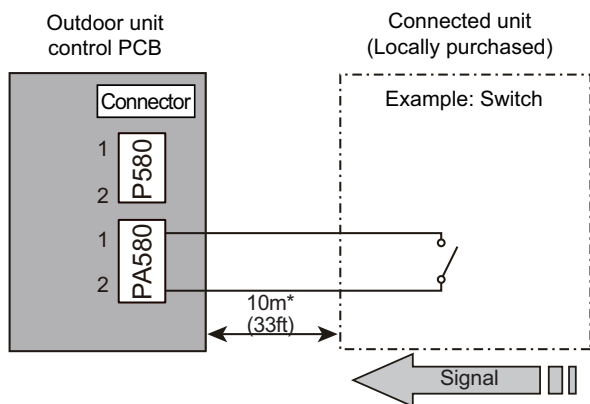

- Contact capacity: DC 24 V or more, 10 mA or more.
- \*: Make the distance from the PCB to the connected unit within 33 ft (10 m).
- Construct a circuit as shown in this figure with using optional parts mentioned below.
- Input signal: On in “Peak cut mode”
- Input signal: Off in normal operation
- To set the level of “Peak cut mode”, refer to “Peak cut mode” on page 92.

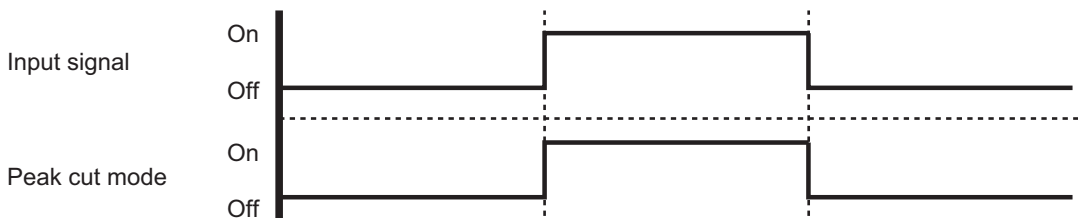

### • Optional part

Part name	Model name	Exterior
External connect kit	UTY-XWZXZ3	External input wire 

## 12-2. External output

With using external output function, some status signals are transmitted to the control PCB, and the related LED lamp indicates the status of this product.

### ■ Error status output

Signal on air conditioner error status is generated when a malfunction occurs.

#### • Circuit diagram example

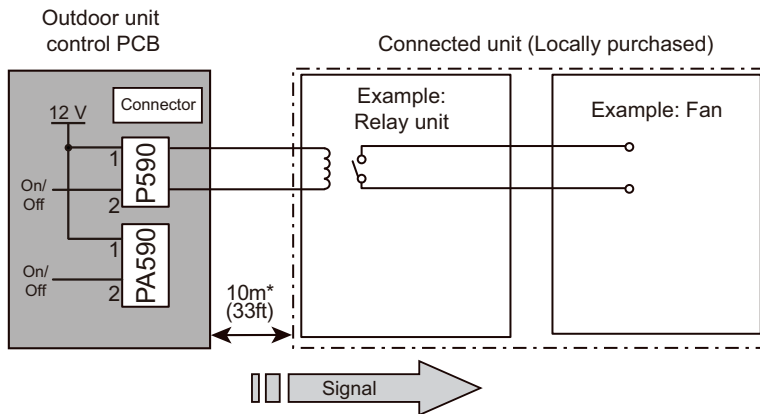

- Output voltage (Vcc): DC 12 V 50 mA or less
- \*: Make the distance from the PCB to the connected unit within 33 ft (10 m).

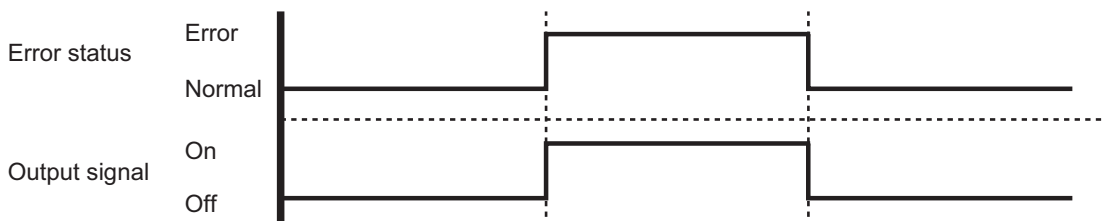

#### • Optional part

Part name	Model name	Exterior
External connect kit	UTY-XWZXZ3	External output wire 

## Compressor status output

Signal on compressor operation status is generated when the compressor is running.

### Circuit diagram example

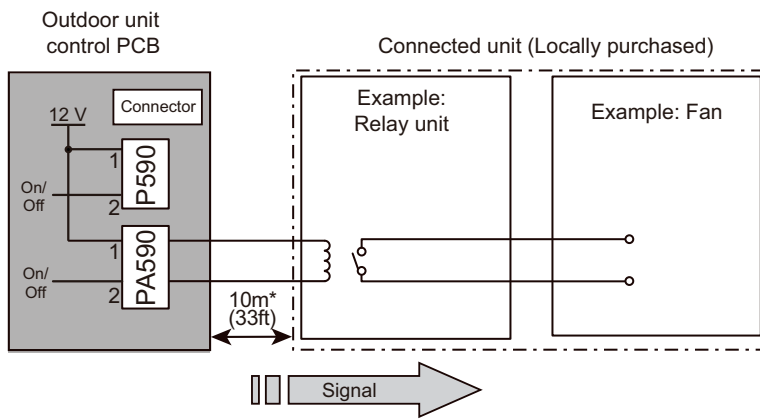

- Output voltage (Vcc): DC 12 V 50 mA or less
- \*: Make the distance from the PCB to the connected unit within 33 ft (10 m).

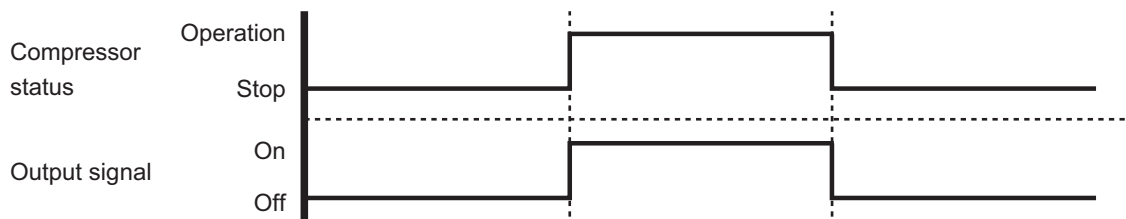

### Optional part

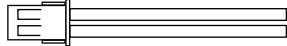
Part name	Model name	Exterior
External connect kit	UTY-XWZXZ3	External output wire 

## 13. Function settings

Perform appropriate function setting locally according to the installation environment.

**NOTE:** Incorrect settings can cause a product malfunction.

### ⚠ CAUTION

- Before setting up the switch buttons, discharge the static electricity from your body.
- Never touch the terminals or the patterns on the parts that are mounted on the PCB.

### 13-1. Control PCB and switch buttons location

Control PCB of the outdoor unit is located as shown in the following figure.

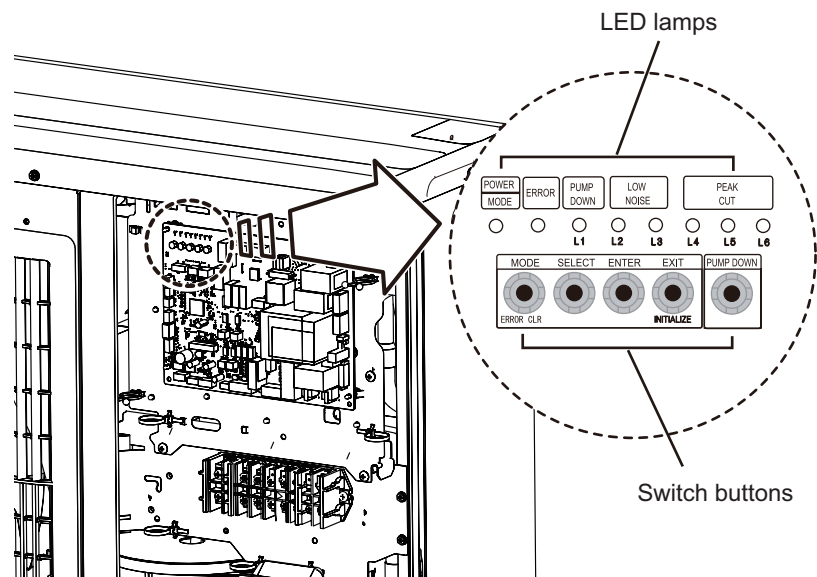

## Switch buttons and the functions

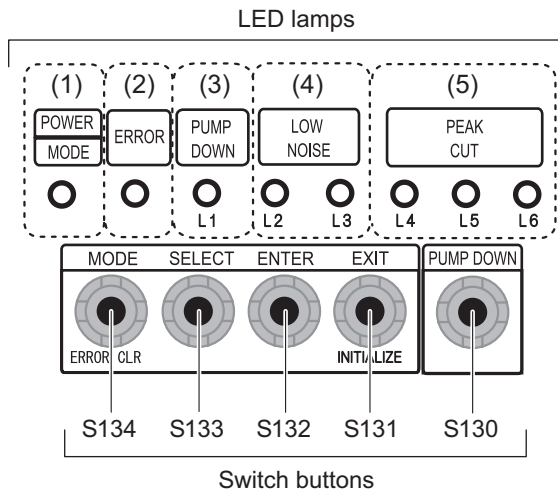

LED lamp			Function or operation method
(1)	POWER/MODE	Green	Lights on while power on. Local setting in outdoor unit or error code is displayed with blink.
(2)	ERROR	Red	Blinks during error operation.
(3)	PUMP DOWN (L1)	Orange	Lights on during pump down operation.
(4)	LOW NOISE MODE (L2 and L3)	Orange	Lights on during "Low noise mode" when local setting is activated. (Lighting pattern of L2 and L3 indicates low noise level.)
(5)	PEAK CUT MODE (L4, L5, and L6)	Orange	Lights on during "Peak cut mode" when local setting is activated. (Lighting pattern of L4, L5, and L6 indicates peak cut level.)

Switch button		Function or operation method
S134	MODE	Switches between "Local setting" and "Error code display".
S133	SELECT	Switches between the individual "Local settings" and the "Error code displays".
S132	ENTER	Switches between the individual "Local settings" and the "Error code displays".
S131	EXIT	Returns to "Operation status display".
S130	PUMP DOWN	Starts the pump down operation.

## 13-2. Local setting procedure

**NOTE:** Before performing the function setting, be sure to stop the operation of the air conditioner.

### Low noise mode

1. Press the MODE switch button (S134) for 3 seconds or more to switch to "Local setting mode".
2. After confirming the LED lamp of POWER/MODE blinks 9 times, press the ENTER switch button (S132).

POWER MODE	ERROR	PUMP DOWN (L1)	LOW NOISE (L2) (L3)		PEAK CUT (L4) (L5) (L6)		
Blinks (9 times)	○	○	○	○	○	○	○

Sign "○": Lights off

3. Press the SELECT switch button (S133), and adjust the LED lamp as shown below. Then the LED lamp indicates the current setting.

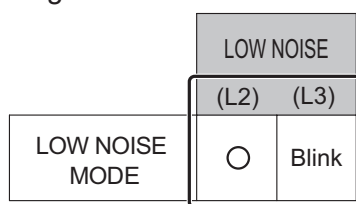

4. Press the ENTER switch button (S132).

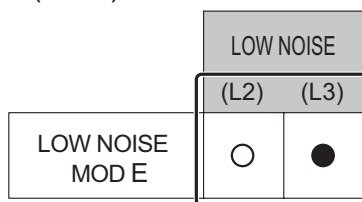

Sign "●": Lights on

5. Press the SELECT switch button (S133), and adjust the LED lamps as shown below.

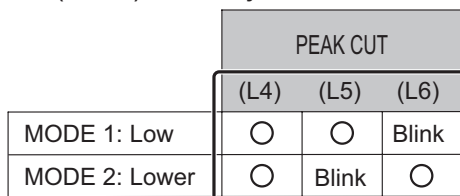

6. Press the ENTER switch button (S132) and fix it.

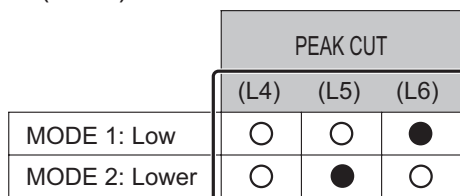

7. To return to "Operating status display (Normal operation)", press the EXIT switch button (S131).

#### In case of missing how many times you pressed the SELECT and ENTER switch buttons:

1. To return to "Operation status display (Normal operation)", press the EXIT switch button once.
2. Restart from the beginning of setting procedure.

## ■ Peak cut mode

1. Press the MODE switch button (S134) for 3 seconds or more to switch to “Local setting mode”.
2. After confirming the LED lamp of POWER/MODE blinks 9 times, press the ENTER switch button (S132).

POWER MODE	ERROR	PUMP DOWN (L1)	LOW NOISE		PEAK CUT		
			(L2)	(L3)	(L4)	(L5)	(L6)
Blinks (9 times)	○	○	○	○	○	○	○

Sign “○”: Lights off

3. Press the SELECT switch button (S133), and adjust the LED lamp as shown below. Then the LED lamp indicates the current setting.

		LOW NOISE	
		(L2)	(L3)
PEAK CUT MODE	Blink	○	

4. Press the ENTER switch button (S132).

		LOW NOISE	
		(L2)	(L3)
PEAK CUT MODE	●	○	

Sign “●”: Lights on

5. Press the SELECT switch button (S133), and adjust the LED lamps as shown below.

	PEAK CUT		
	(L4)	(L5)	(L6)
0 % of rated input ratio	○	○	Blink
50 % of rated input ratio	○	Blink	○
75 % of rated input ratio	○	Blink	Blink
100 % of rated input ratio	Blink	○	○

6. Press the ENTER switch button (S132) and fix it.

	PEAK CUT		
	(L4)	(L5)	(L6)
0 % of rated input ratio	○	○	●
50 % of rated input ratio	○	●	○
75 % of rated input ratio	○	●	●
100 % of rated input ratio	●	○	○



7. To return to “Operating status display (Normal operation)”, press the EXIT switch button (S131).

**NOTE:** When pressed number is lost during setting, you must redo the setting procedure. Return to “Operation status display (Normal operation)” by pressing the EXIT switch button once, and restart from the beginning of the setting procedure.



## 14. Accessories

### 14-1. Models: AOUH18LMAS1 and AOUH24LMAS1

Part name	Exterior	Q'ty	Part name	Exterior	Q'ty
Installation manual		1	Drain cap		3
Drain pipe		1			

## 15. Optional parts

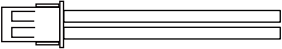
Exterior	Part name	Model name	Summary
	External connect kit	UTY-XWZXZ3	Use to operate the external input and output functions of outdoor unit.