

- ALL STEEL CONSTRUCTION
- INTEGRAL MULTI-SHUTTER DAMPER
- 1/2 INCH SPACED FINS SET AT 45 DEGREES
- MINIMUM SIZE = 6 X 6
- MAXIMUM SIZE = 16 X 16
- 3-WAY DEFLECTION
- FOR HEATING OR COOLING
- FINISH: WHITE (W) ENAMEL

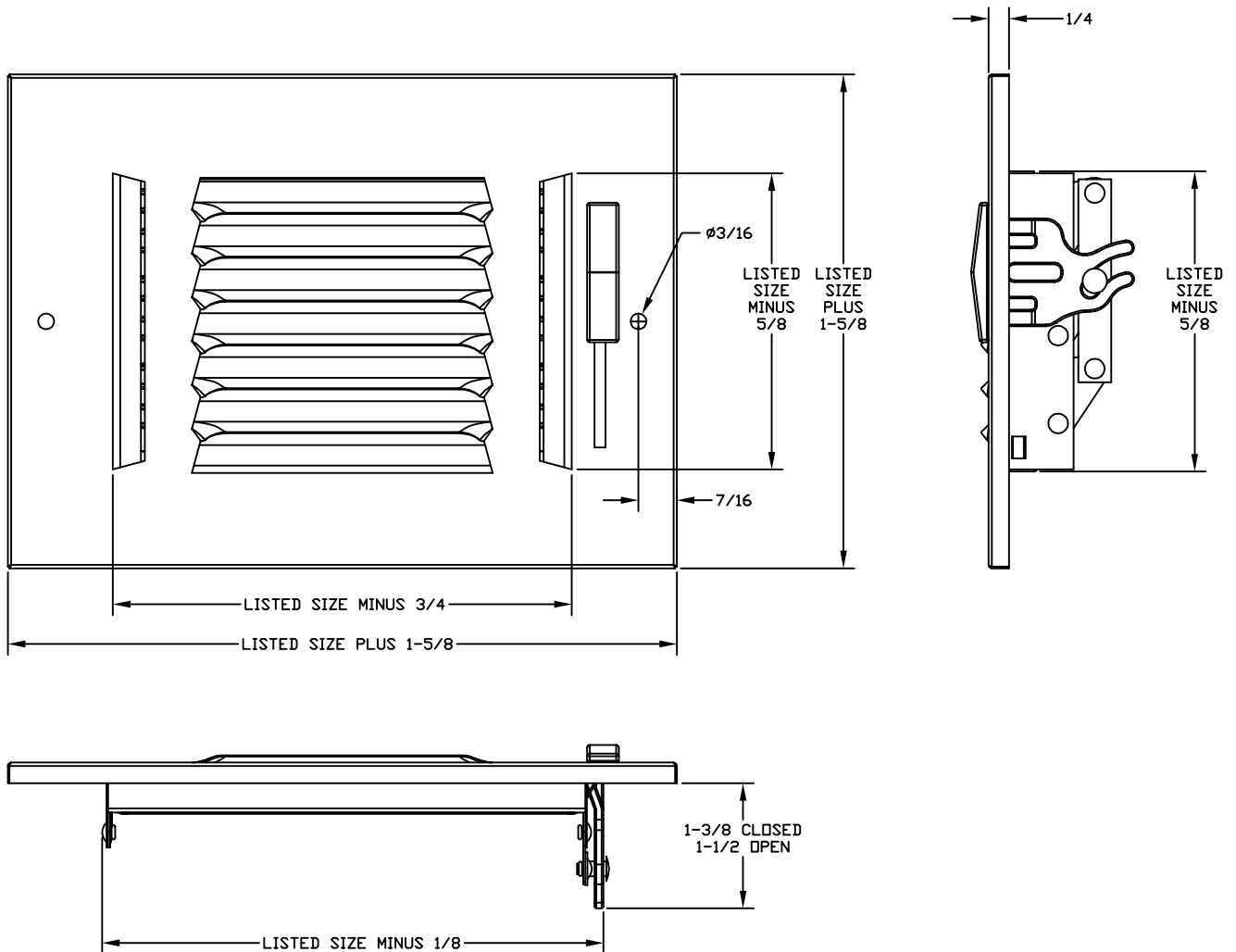

JOB NAME: _____	SUBMITTED BY: _____	DATE: 08/05/2020	SD-2437
LOCATION: _____		683	
ARCHITECT: _____		Steel 3-Way	
ENGINEER: _____		Ceiling Or Sidewall Register	
CONTRACTOR: _____			