

- ALL STEEL CONSTRUCTION
- ADJUSTABLE BARS ON 3/4 INCH CENTERS
- MINIMUM SIZE: 6 X 4
- MAXIMUM SIZE: 48 X 48 ONE PIECE CONSTRUCTION
- AVAILABLE IN 1 INCH INCREMENTS
- FINISH: WHITE (W) ENAMEL

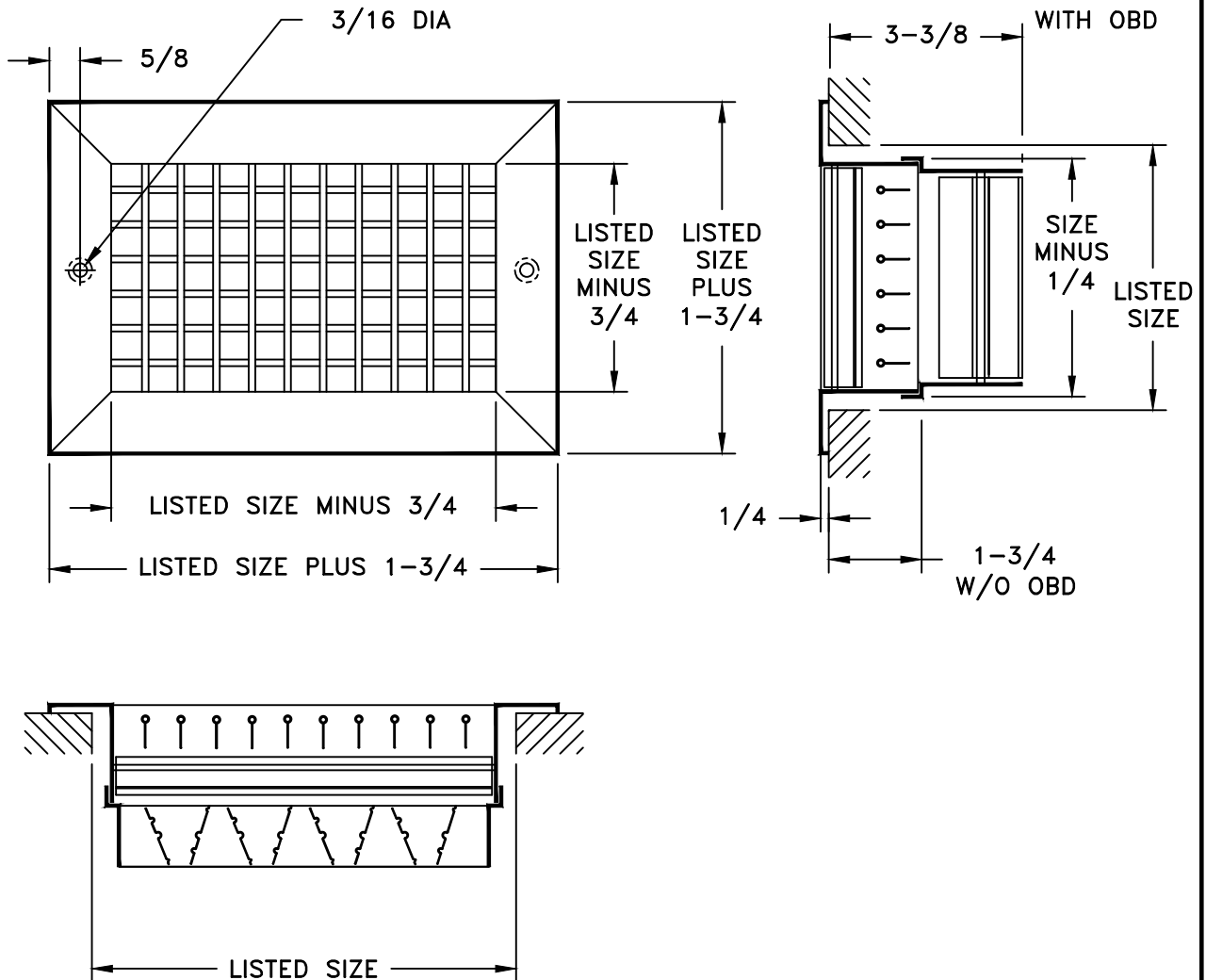

JOB NAME: _____	SUBMITTED BY: _____	DATE: 03/08/2021	SD-9008
LOCATION: _____		92VHO, 92VHV	
ARCHITECT: _____		Steel Supply Register	
ENGINEER: _____		Double Deflection	
CONTRACTOR: _____		Vertical Front Bars	