

Inverter Driven Heat Pump

9,000 BTU Compact Cassette Type

Job Name _____
 Location _____
 Engineer _____
 Submitted To _____
 Submitted By _____
 Reference _____

Date _____
 Approval _____
 Construction _____
 Unit No _____
 Drawing No _____

PRODUCT FEATURES

- Automatic airflow adjustment
- Auto/Cool/Dry/Fan/Heat/modes
- 24 Hr. timer
- Powerful mode
- Fresh Air Knockout
- Fresh Air Kit
- Auto changeover
- Cold prevention
- Compact size - Grid fit



MODEL NUMBERS

Indoor Unit	ACUH09LUAS1
Nominal Capacity	9,000

LINESET REQUIREMENTS

Connection Method	Flare	
Liquid	in (mm)	Ø1/4 (Ø 6.35)
Gas		Ø3/8 (Ø9.52)
Drain hose	Material	PVC
	in	Ø 1 (I.D.), Ø 1-1/4 (O.D.)
	mm	Ø 25 (I.D.), Ø 32 (O.D.)

INDOOR DIMENSIONS & WEIGHT

Net (H x W x D)	in	9-5/8 x 22-7/16 x 22-7/16
	mm	245 x 570 x 570
Gross (H x W x D)	in	10-7/16 x 28-3/4 x 24-5/8
	mm	265 x 730 x 625
Net Weight	lb (kg)	33 (15)
Gross Weight		40 (18)

ELECTRICAL SPECIFICATIONS

Voltage/Frequency/Phase	208/230 V ~ 60 Hz	
Voltage Range	187-264 V	
Running Current	A	0.15
Input Power	W	18

SOUND PRESSURE

Indoor Unit	Cooling	High	dB (A)	33
		Medium		31
		Low		29
		Quiet		27
	Heating	High	dB (A)	34
		Medium		32
		Low		29
		Quiet		27

FAN DATA

Airflow Rate	Cooling	High	CFM (m3/h)	318 (540)
		Medium		288 (490)
		Low		259 (440)
		Quiet		230 (390)
	Heating	High	CFM (m3/h)	318 (540)
		Medium		288 (490)
		Low		259 (440)
		Quiet		230 (390)

Warranty Information



7 Year Compressor, 5 Year Parts out-of-the-box Warranty



10 Year Compressor, 10 Year Parts Warranty when registered within 60 days of installation in a residence



12 Year Compressor, 12 Year Parts Warranty when registered within 60 days of installation in a residence, and installed by a Fujitsu Elite contractor

ENCLOSURE

Enclosure	Material	Polystyrene
	Color	White

ACCESSORIES

UTY-XWZXZG	External Connect Kit
UTY-TFSXZ2	Wireless LAN Interface
UTY-RNRUZ Series	Wired Remote Controller
UTY-RHRY	Simple Remote Controller
UTY-RSRY	Simple Remote Controller
UYT-LNTU	Wireless Remote Controller
UTZ-VXAA	Fresh Air Intake
UTR-YDZB	Air Outlet Shutter Plate
UTZ-VMSX	MODBUS Converter
FJ-AC-BAC-1L	BACnet Gateway
UTG-CCGFGA	Cassette Grille



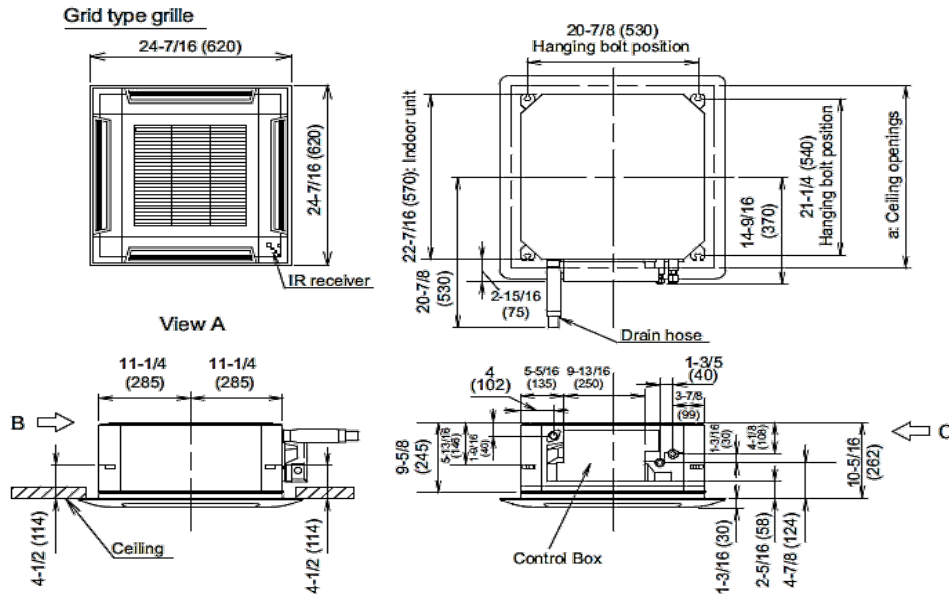

■ Installation space requirement

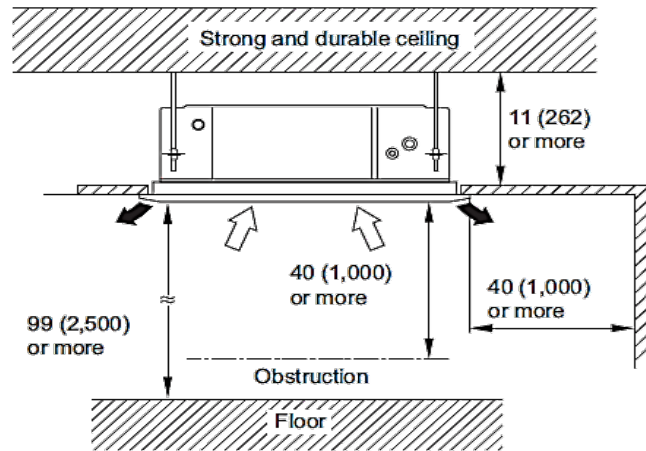

The Fujitsu logo is a worldwide trademark of Fujitsu General Limited. The Halcyon logo and name is a worldwide trademark of Fujitsu General America, Inc. Fujitsu's products are subject to continuous improvements. Fujitsu reserves the right to modify product design, specifications and information in this brochure without notice and without incurring any obligations.

Note: Specifications are based on the following conditions:
 Cooling: Indoor temperature of 80°F (26.7°C) DB/67°F (19.4°C) WB, and outdoor temperature of 95°F (35°C) DB/75°F (23.9°C) WB. Heating: Indoor temperature of 70°F (21.1°C) DB/60°F (15.6°C) WB, and outdoor temperature of 47°F (8.3°C) DB/43°F (6.1°C) WB. Pipe length: 25ft. (7.5m), Height difference: 0ft. (0m) (Outdoor unit - indoor unit).