

Contents

1. SAFETY PRECAUTIONS.....	1
1.1. IMPORTANT! Please read before starting.....	1
1.2. Special precautions.....	1
2. PRODUCT SPECIFICATION.....	2
2.1. Installation tools.....	2
2.2. Accessories.....	3
2.3. Pipe requirement.....	3
2.4. Power source.....	3
2.5. Electric requirement.....	3
2.6. Additional charge.....	3
2.7. Operating range.....	4
3. INSTALLATION WORK.....	4
3.1. Selecting an installation location.....	4
3.2. Installation dimensions.....	4
3.3. Transporting the unit.....	5
3.4. Mounting the unit.....	6
3.5. Drain installation.....	6
3.6. Removing and replacing parts.....	6
3.7. Opening the knockout hole.....	6
3.8. Pipe installation.....	7
3.9. Sealing test.....	8
3.10. Vacuum process.....	8
3.11. Additional charging.....	8
3.12. Electrical wiring.....	9
4. HOW TO OPERATE DISPLAY UNIT.....	11
4.1. Various setting methods.....	11
4.2. Base heater forced off function.....	12
4.3. Outdoor unit low noise operation function (option).....	12
5. TEST RUN.....	12
5.1. TEST RUN method.....	12
6. FINISHING.....	12
6.1. Installing insulation.....	12
6.2. Filling with putty.....	12
7. CUSTOMER GUIDANCE.....	13
8. ERROR CODE.....	13
8.1. In the event of an error.....	13
8.2. Error location display.....	13
8.3. Error code display.....	13
9. PUMP DOWN.....	14

Installation must be performed in accordance with the requirement of NEC and CEC by authorized personnel only.

1. SAFETY PRECAUTIONS

1.1. IMPORTANT! Please read before starting

This air conditioning system meets strict safety and operating standards. As the installer or service person, it is an important part of your job to install or service the system so it operates safely and efficiently.

For safe installation and trouble-free operation, you must:

- Carefully read this instruction booklet before beginning.
- Follow each installation or repair step exactly as shown.
- Observe all local, state, and national electrical codes.
- Pay close attention to all warning and caution notices given in this manual.

WARNING: This symbol refers to a hazard or unsafe practice which can result in severe personal injury or death.

CAUTION: This symbol refers to a hazard or unsafe practice which can result in personal injury and the potential for product or property damage.

- Hazard alerting symbols



Electrical



Safety/alert

If Necessary, Get Help

These instructions are all you need for most installation sites and maintenance conditions. If you require help for a special problem, contact our sales/service outlet or your certified dealer for additional instructions.

In Case of Improper Installation

The manufacturer shall in no way be responsible for improper installation or maintenance service, including failure to follow the instructions in this document.

1.2. Special precautions

When Wiring

ELECTRICAL SHOCK CAN CAUSE SEVERE PERSONAL INJURY OR DEATH. ONLY A QUALIFIED, EXPERIENCED ELECTRICIAN SHOULD ATTEMPT TO WIRE THIS SYSTEM.

- Do not supply power to the unit until all wiring and tubing are completed or reconnected and checked.
- Highly dangerous electrical voltages are used in this system. Carefully refer to the wiring diagram and these instructions when wiring. Improper connections and inadequate earthing (grounding) can cause accidental injury or death.
- Earth (Ground) the unit following local electrical codes.
- Connect all wiring tightly. Loose wiring may cause overheating at connection points and a possible fire hazard.

When Transporting

Be careful when picking up and moving the indoor and outdoor units. Get a partner to help, and bend your knees when lifting to reduce strain on your back. Sharp edges or thin aluminum fins on the air conditioner can cut your fingers.

When Installing...

...In a Ceiling or Wall

Make sure the ceiling/wall is strong enough to hold the unit's weight. It may be necessary to construct a strong wood or metal frame to provide added support.

...In a Room

Properly insulate any tubing run inside a room to prevent "sweating" that can cause dripping and water damage to walls and floors.

...In Moist or Uneven Locations

Use a raised concrete pad or concrete blocks to provide a solid, level foundation for the outdoor unit. This prevents water damage and abnormal vibration.

...In an Area with High Winds

Securely anchor the outdoor unit down with bolts and a metal frame. Provide a suitable air baffle.

...In a Snowy Area (for Heat Pump-type Systems)

Install the outdoor unit on a raised platform that is higher than drifting snow.

When Connecting Refrigerant Tubing

- Keep all tubing runs as short as possible.
- Use the flare method for connecting tubing.
- Apply refrigerant lubricant to the matching surfaces of the flare and union tubes before connecting them, then tighten the nut with a torque wrench for a leak-free connection.
- Check carefully for leaks before opening the refrigerant valves.

NOTE:

Depending on the system type, liquid and gas lines may be either narrow or wide. Therefore, to avoid confusion the refrigerant tubing for your particular model is specified as either "small" or "large" rather than as "liquid" or "gas".

When Servicing

- Turn the power OFF at the main circuit breaker panel before opening the unit to check or repair electrical parts and wiring.
- Keep your fingers and clothing away from any moving parts.
- Clean up the site after you finish, remembering to check that no metal scraps or bits of wiring have been left inside the unit being serviced.
- After installation, explain correct operation to the customer, using the operating manual.
- Please pass this Installation manual together with the Operating manual to the customer. Please ask the customer to keep the Operating manual and Installation manual at hand for future reference during the moving or repair of the main unit.

WARNING

- To avoid getting an electric shock, never touch the electrical components soon after the power supply has been turned off. After turning off the power, always wait 10 minutes or more before you touch the electrical components.
- Installation of this product must be done by experienced service technicians or professional installers only in accordance with this manual. Installation by non-professional or improper installation of the product might cause serious accidents such as injury, water leakage, electric shock, or fire. If the product is installed in disregard of the instructions in this manual, it will void the manufacturer's warranty.
- Do not turn on the power until all work has been completed. Turning on the power before the work is completed can cause serious accidents such as an electric shock or a fire.
- If refrigerant leaks when you are working, ventilate the area. If the leaking refrigerant is exposed to a direct flame, it may produce a toxic gas.
- If there is a refrigerant leakage, make sure that it does not exceed the concentration limit.
If a refrigerant leakage exceeds the concentration limit, it can lead to accidents such as oxygen starvation.
- After the installation, make sure there is no refrigerant leakage.
If the refrigerant leaks into the room and becomes exposed to a source of fire such as a fan heater, stove, or burner, it will create a hazardous gas.
- Installation must be performed in accordance with regulations, codes, or standards for electrical wiring and equipment in each country, region, or the installation place.
- Do not use this equipment with air or any other unspecified refrigerant in the refrigerant lines. Excess pressure can cause a rupture.
- Be sure to install the refrigerant pipe before operating the compressor. If the refrigerant pipe is not installed and you operate the compressor while the valve is open, air will be sucked into the system and abnormal pressure will occur in the refrigerant cycle. This will damage the unit and cause injuries.
- When installing or relocating the air conditioner, do not mix gases other than the specified refrigerant (R410A) to enter the refrigerant cycle.
If air or other gas enters the refrigerant cycle, the pressure inside the cycle will rise to an abnormally high value and cause rupture, injury, etc.
- For appropriate working of the air conditioner, install it as written in this manual.
- To connect indoor unit and outdoor unit, or indoor unit and branch box, use air conditioner piping and cables available through your local distributor. This manual describes proper connections using such installation set.
- Do not modify power cable, use extension cable or branch wiring. Improper use may cause electric shock or fire by poor connection, insufficient insulation or over current.
- Do not purge the air with refrigerants but use a vacuum pump to vacuum the installation.
- There is no extra refrigerant in the outdoor unit for air purging.
- Do not use means to accelerate the defrosting process or to clean, other than those recommended by the manufacturer.
- For wiring, use the prescribed type of cables, connect them securely, making sure that there are no external forces of the cables applied to the terminal connections. Improperly connected or secured cables can cause serious accidents such as overheating the terminals, electric shock, or fire.
- Install a breaker to cut off all AC main current at the same time.
If you do not install a breaker, it may cause electric shock and fire.
- The appliance shall be stored in a room without continuously operating ignition sources (for example: open flames, an operating gas appliance or an operating electric heater).
- Do not pierce or burn.
- Be aware that refrigerants may not contain an outdoor.
- If there is a possibility of touching the fan during maintenance, make sure to turn OFF the power before implementing the maintenance. Even if operations are suspended, the fan of outdoor unit sometimes rotates, so if the fan rotates suddenly while in contact with you may cause serious injury.
- Using the same vacuum pump for different refrigerants may damage the vacuum pump or the unit.
- Use a clean gauge manifold, vacuum pump and charging hose for R410A exclusively.
- Do not modify this unit, such as opening a hole in the cabinet.
- During the pump-down operation, make sure that the compressor is turned off before you remove the refrigerant piping.
Do not remove the connection pipe while the compressor is in operation with 2 way or 3 way valve open. This may cause abnormal pressure in the refrigeration cycle that leads to rupture and even injury.
- This appliance is not intended for use by persons (including children) with reduced physical, sensory or mental capabilities, or lack of experience and knowledge, unless they have been given supervision or instruction concerning use of the appliance by a person responsible for their safety. Children should be supervised to ensure that they do not play with the appliance.
- To avoid danger of suffocation, keep the plastic bag or thin film used as the packaging material away from young children.
- When installing this system in high humidity locations, install using ground fault equipment breakers (often referred to in other countries as an ELCB [earth leakage current breaker]) to reduce the risk of leaking current which may result in electric shock or potential fire.
- Cancer and Reproductive Harm - www.P65Warnings.ca.gov.

CAUTION

- This unit must be installed by qualified personnel with a capacity certification of handling refrigerant fluids. Refer to regulation and laws in use on installation place.
- Install the unit by following local codes and regulations in force at the place of installation, and the instructions provided by the manufacturer.
- This unit is part of a set constituting an air conditioner. The unit must not be installed alone or be installed with non-authorized device by the manufacturer.
- When installing pipes shorter than 3 m, sound of the outdoor unit will be transferred to the indoor unit, which will cause large operating sound or some abnormal sound.
- To protect the persons, earth (ground) the unit correctly, and use the power cable combined with an Earth Leakage Circuit Breaker (ELCB).
- The units are not explosion proof, and therefore should not be installed in explosive atmosphere.
- This unit contains no user-serviceable parts. Always consult experienced service technicians for repairing.
- When moving or relocating the air conditioner, consult experienced service technicians for disconnection and reinstallation of the unit.
- Children should be monitored to ensure they do not play with the device.
- Do not touch the aluminum fins of heat exchanger built-in the indoor or outdoor unit to avoid personal injury when you install or maintain the unit.
- Do not place any other electrical products or household belongings under indoor unit or outdoor unit. Condensation dripping from the unit might get them wet, and may cause damage or malfunction of your property.
- Do not use the unit for special purposes, such as storing food, raising animals, growing plants, or preserving precision devices or art objects. It can degrade the quality of the preserved or stored objects.
- Be sure not to start or stop the operation of air conditioning with power breaker. Otherwise, it may cause malfunction or water leakage.
- When setting it up near the equipment that generates electromagnetic waves and the equipment that generates the higher harmonics wave, be sure to take measures against noise. Otherwise, it may cause malfunction or failure.
- When energizing to the compressor heater, turn on the power 12 hours or earlier before operation begins. When the energizing time is short, it may cause failure. Besides, do not turn off power during the busy season.

2. PRODUCT SPECIFICATION

- All products are manufactured to metric units and tolerances. United States customary units are provided for reference only. In cases where exact dimensions and tolerances are required, always refer to metric units.

2.1. Installation tools

WARNING

To install a unit that uses R410A refrigerant, use dedicated tools and piping materials that have been manufactured specifically for R410A use. Because the pressure of R410A refrigerant is approximately 1.6 times higher than R22, failure to use dedicated piping material or improper installation can cause rupture or injury. Furthermore, it can cause serious accidents such as water leakage, electric shock, or fire.

Tool name	Change from R22 to R410A
Gauge manifold	Pressure is huge and cannot be measured with a conventional gauge. To prevent erroneous mixing of other refrigerants, the diameter of each port has been changed. It is recommended to use a gauge manifold with a high pressure display range 500 microns to 768 psi (-0.1 to 5.3 MPa) and a low pressure display range 500 microns to 551 psi (-0.1 to 3.8 MPa).
Charge hose	To increase pressure resistance, the hose material and base size were changed. (R410A)
Vacuum pump	A conventional vacuum pump can be used by installing a vacuum pump adapter. (Use of a vacuum pump with a series motor is prohibited.) Be sure that the pump oil does not back flow into the system. Use one capable for vacuum suction of 500 microns (-100.7 kPa).
Gas leakage detector	Special gas leakage detector for HFC refrigerant R410A.

■ Copper pipes

It is necessary to use seamless copper pipes and it is desirable that the amount of residual oil is less than 0.0014 oz/33 ft (40 mg/10 m). Do not use copper pipes having a collapsed, deformed or discolored portion (especially on the interior surface). Otherwise, the expansion valve or capillary tube may become blocked with contaminants. As an air conditioner using R410A incurs pressure higher than when using R22, it is necessary to choose adequate materials. Thicknesses of copper pipes used with R410A are as shown in table. Never use copper pipes thinner than those indicated in the table even if they are available on the market.

Thicknesses of Annealed Copper Pipes



Nominal diameter (in)	Outer diameter (mm)	Thickness [in(mm)]
1/4	6.35	0.032 (0.80)
3/8	9.52	
1/2	12.70	
5/8	15.88	0.039 (1.00)
3/4	19.05	0.047 (1.20)

2.2. Accessories

⚠ WARNING

For installation purposes, be sure to use the parts supplied by the manufacturer or other prescribed parts. The use of non-prescribed parts can cause serious accidents such as the unit falling, water leakage, electric shock, or fire.

- The following installation parts are supplied. Use them as required.
- Keep the Installation Manual in a safe place and do not discard any other accessories until the installation work has been completed.

Name and Shape	Q'ty	Name and Shape	Q'ty
Installation manual (This manual) 	1	Drain pipe 	1
Drain cap 	7		

One set of following parts are necessary installation of this product.

Additional materials

Connection pipe assembly	Decorative tape	Saddle	Tapping screws
Connection cable	Vinyl tape	Drain hose	Sealant
Wall pipe	Wall cap	M10 bold, nut	

2.3. Pipe requirement

2.3.1. Protection of pipes

- Protect the pipes to prevent the entry of moisture and dust.
- Especially, pay attention when passing the pipes through a hole or connecting the end of a pipe to the outdoor unit.

Location	Working period	Protection method
Outdoor	1 month or more	Pinch pipes
	Less than 1 month	Pinch or tape pipes
Indoor	-	Pinch or tape pipes

2.3.2. Refrigerant pipe size and allowable piping length

⚠ CAUTION

- Keep the piping length between the indoor unit and outdoor unit within the allowable tolerance.
- The maximum lengths of this product are shown in the table. If the units are further apart than this, correct operation cannot be guaranteed.

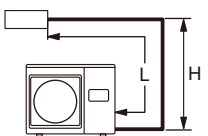
Model	36 model	48 model
Pipe diameter <Liquid/Gas> [in (mm)]	3/8 (9.52) / 5/8 (15.88)	
Max. piping length (L) [ft (m)]	229 (70)	
Max. height difference (H) <Indoor unit to outdoor unit> [ft (m)]	98 (30)	
View (Example)		

2.4. Power source

⚠ WARNING

- Always use a special branch circuit and install a special receptacle to supply power to the room air conditioner.
- Use a circuit breaker and receptacle matched to the capacity of the air conditioner.
- Do not extend the power cord.
- Perform wiring work in accordance with standards so that the air conditioner can be operated safely and positively.
- Install a leakage circuit breaker in accordance with the related laws and regulations and electric company standards.
- The circuit breaker is installed in the permanent wiring. Always use a circuit that can trip all the poles of the wiring and has an isolation distance of at least 3 mm between the contacts of each pole.

⚠ CAUTION

- The power source capacity must be the sum of the air conditioner current and the current of other electrical appliances. When the current contracted capacity is insufficient, change the contracted capacity.
- When the voltage is low and the air conditioner is difficult to start, contact the power company the voltage raised.

2.5. Electric requirement

⚠ CAUTION

- Be sure to install a breaker of the specified capacity.
- Regulation of cables and breaker differs from each locality, refer in accordance with local rules.

Voltage rating	1 ø 208/230 V (60 Hz)
Operating range	187-253 V

Cable	Size *1)	Remarks
Power supply cable	8AWG	2 cable + Earth (Ground), 1 ø 208/230 V
Connection cable	14AWG	3 cable + Earth (Ground), 1 ø 208/230 V

*1) Select the correct cable type and size according to the country or region's regulations. Max. wire length: Set a length so that the voltage drop is less than 2%. Increase the wire diameter when the wire length is long.

Model	MCA	MAX. CKT. BKR.	GFEB
36, 48	39.9 A	40 A	30 mA 0.1 s or less

MCA: Minimum Circuit Ampacity
MAX. CKT. BKR.: Maximum Circuit Breaker
GFEB: Ground Fault Equipment Breaker

- Before starting work check that power is not being supplied to all poles of the indoor unit and outdoor unit.
- Install all electrical works in accordance to the national standard.
- Install the disconnect device with a contact gap of at least 3 mm in all poles nearby the units. (Both indoor unit and outdoor unit)
- Install the circuit breaker nearby the units.

2.6. Additional charge

⚠ CAUTION

When adding refrigerant, add the refrigerant from the charging port at the completion of work.

Refrigerant suitable for a piping length of 98 ft (30 m) is charged in the outdoor unit at the factory.

When the piping is longer than 98 ft (30 m), additional charging is necessary.

For the additional amount, refer to the following table.

Pipe length	98 ft (30 m)	131 ft (40 m)	164 ft (50 m)	197 ft (60 m)	229 ft (70 m)	Rate
Additional refrigerant	None	+14 oz (+400 g)	+28 oz (+800 g)	+42 oz (+1200 g)	+56 oz (+1600 g)	0.4 oz/ft (40 g/m)

2.7. Operating range

	Outdoor temperature
Cooling/Dry Mode	14 to 115 °F (-10 to 46 °C)
Heating Mode	-5 to 75 °F (-20 to 24 °C)

3. INSTALLATION WORK

Make sure to obtain the customer's approval for selecting and installing the outdoor unit.

3.1. Selecting an installation location

⚠ WARNING

- Securely install the outdoor unit at a location that can withstand the weight of the unit. Otherwise, the outdoor unit may fall and cause injury.
- Calculate the proper refrigerant concentration if you will be installing it in an enclosed location.

$$\frac{\text{Total amount of replenished refrigerant in refrigerant facility [lb (kg)]}}{\text{Capacity of smallest room where unit is installed [1,000 ft}^3 \text{ (m}^3\text{)]}} \leq \frac{\text{Refrigerant concentration}}{\text{[lb/1,000 ft}^3 \text{ (kg/m}^3\text{)]}} \leq \frac{\text{[25 lb/1,000 ft}^3 \text{ (0.40 kg/m}^3\text{)]}}$$

If the results of the calculation exceed the concentration limit, increase the room surface area or install a ventilation duct.

- Be sure to install the outdoor unit as prescribed, so that it can withstand earthquakes and typhoons or other strong winds. Improper installation can cause the unit to topple or fall, or other accidents.
- Do not install the outdoor unit near the edge of a balcony. Otherwise, children may climb onto the outdoor unit and fall off of the balcony.

⚠ CAUTION

- Do not install the outdoor unit in the following areas:
 - Area with high salt content, such as at the seaside. It will deteriorate metal parts, causing the parts to fail or the unit to leak water.
 - Area filled with mineral oil or containing a large amount of splashed oil or steam, such as a kitchen. It will deteriorate plastic parts, causing the parts to fail or the unit to leak water.
 - Area that generates substances that adversely affect the equipment, such as sulfuric gas, chlorine gas, acid, or alkali. It will cause the copper pipes and brazed joints to corrode, which can cause refrigerant leakage.
 - Area containing equipment that generates electromagnetic interference. It will cause the control system to malfunction, preventing the unit from operating normally.
 - Area that can cause combustible gas to leak, contains suspended carbon fibers or flammable dust, or volatile inflammables such as paint thinner or gasoline. If gas leaks and settles around the unit, it can cause a fire.
 - Area that has heat sources, vapors, or the risk of the leakage of flammable gas in the vicinity.
 - Area where small animals may live. It may cause failure, smoke or fire if small animals enter and touch internal electrical parts.
 - Area where animals may urinate on the unit or ammonia may be generated.
- Do not tilt the outdoor unit more than 3 degrees. However, do not install the unit with it tilted towards the side containing the compressor.
- Install the outdoor unit in a well-ventilated location away from rain or direct sunlight.
- If the outdoor unit must be installed in an area within easy reach of the general public, install as necessary a protective fence or the like to prevent their access.
- Install the outdoor unit in a location that would not inconvenience your neighbors, as they could be affected by the airflow coming out from the outlet, noise, or vibration. If it must be installed in proximity to your neighbors, be sure to obtain their approval.
- If the outdoor unit is installed in a cold region that is affected by snow accumulation, snow fall, or freezing, take appropriate measures to protect it from those elements. To ensure a stable operation, install inlet and outlet ducts.
- Install the unit in an area that would not cause problems even if the drain water is discharged from the unit. Otherwise, provide drainage that would not affect people or objects.
- Install the outdoor unit in a location that is away from exhaust or the vent ports that discharge vapor, soot, dust, or debris.
- Install the indoor unit, outdoor unit, power supply cable, connection cable, and remote controller cable at least 40 in (1 m) away from a television or radio receivers. The purpose of this is to prevent TV reception interference or radio noise. (Even if they are installed more than 40 in (1 m) apart, you could still receive noise under some signal conditions.)
- If children under 10 years old may approach the unit, take preventive measures so that they cannot reach the unit.
- Keep the length of the piping of the indoor and outdoor units within the allowable range.
- For maintenance purposes, do not bury the piping.

Decide the mounting position with the customer as follows:

- Install the outdoor unit in a location which can withstand the weight of the unit and vibration, and which can install horizontally.
- Provide the indicated space to ensure good airflow.
- If possible, do not install the unit where it will be exposed to direct sunlight. (If necessary, install a blind that does not interfere with the airflow.)
- Do not install the unit near a source of heat, steam, or flammable gas.
- During heating operation, drain water flows from the outdoor unit. Therefore, install the outdoor unit in a place where the drain water flow will not be obstructed.
- Do not install the unit where strong wind blows or where it is very dusty.
- Do not install the unit where people pass.
- Install the outdoor unit in a place where it will be free from being dirty or getting wet by rain as much as possible.
- Install the unit where connection to the indoor unit is easy.

3.2. Installation dimensions

⚠ CAUTION

- Keep the space shown in the installation examples. If the installation is not performed accordingly, it could cause a short circuit and result in a lack of operating performance.
- When there is a wall in front of the unit, provide a space of 20 in (500 mm) or more as maintenance space. When there is a wall at the right side of the unit, provide a space of 2 in (25 mm) or more as maintenance space.
- An outdoor temperature of 95 °F (DB) (35 °C (DB)) in air-conditioned operation is assumed for the installation space in this item. If the outdoor temperature exceeds 95 °F (DB) (35 °C (DB)) and the outdoor unit is operating at a load exceeding its rated ability, provide a larger inlet space.
- If you are installing more outdoor units than indicated here, ensure sufficient space or consult your distributing agent as it may affect the performance due to short circuit and other problems.
- Consider the transportation route, installation space, maintenance space, and access, and install the unit in a location with sufficient space for the refrigerant piping.
- Observe the installation space specifications that are shown in the figures. Keep the same space at rear air intake. Provide the same space for the air intake at the rear of the outdoor unit. If the installation is not performed according to the specifications, it could cause a short circuit and result in a lack of operating performance. As a result, the outdoor unit might easily be stopped by high-pressure protection.
- Installation methods not shown in the following examples are not recommended. Performance may drop significantly.

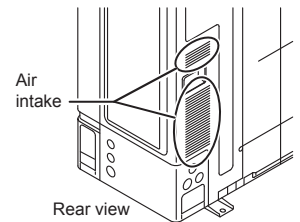

3.2.1. Outdoor unit installation

When the upper space is open [Unit: in (mm)]

(1) Obstacles at rear only

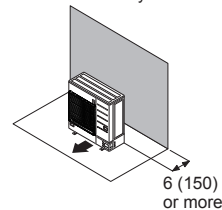

(2) Obstacles at rear and sides

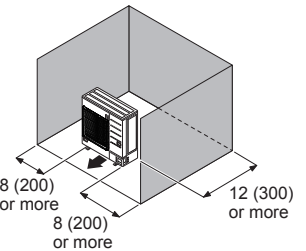

(3) Obstacles at front only

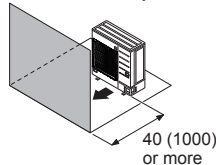

(4) Obstacles at front and rear

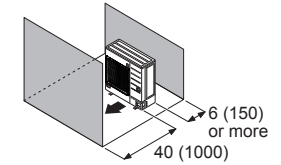

When an obstruction in the upper space [Unit: in (mm)]

(1) Obstacles at rear and above

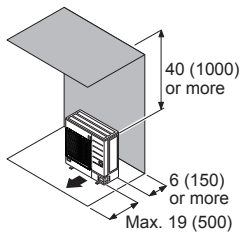

(2) Obstacles at rear, sides, and above

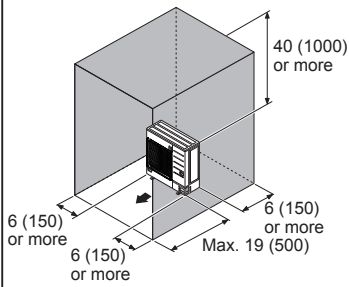

3.2.2. Multiple outdoor unit installation

- Provide at least 10 in (250 mm) of space between the outdoor units if multiple units are installed.
- When routing the piping from the side of an outdoor unit, provide space for the piping.

When the upper space is open [Unit: in (mm)]

(1) Obstacles at rear only

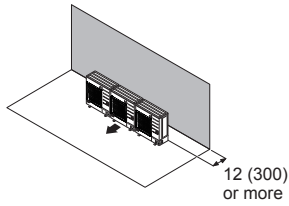

(2) Obstacles at front only

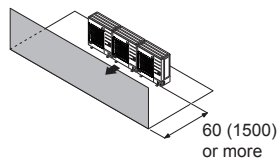

(3) Obstacles at front and rear

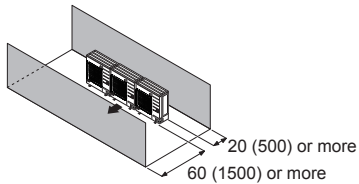

When an obstruction in the upper space [Unit: in (mm)]

Obstacles at rear and above

- Up to 3 units can be installed side by side.
- When 4 units or more are arranged in a line, provide the space as shown below.

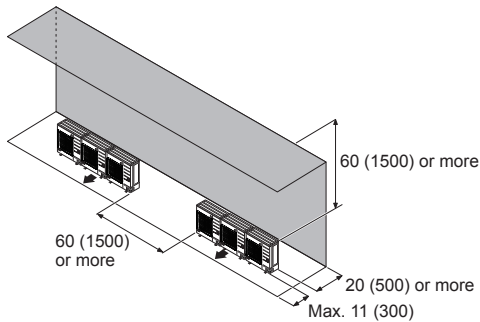

3.2.3. Outdoor units installation multi-row [Unit: in (mm)]

* The following settings are not recommended in case of cooling by a low outside temperature.

(1) Single parallel unit arrangement

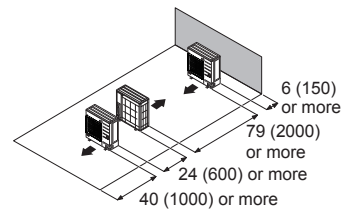

(2) Multiple parallel unit arrangement

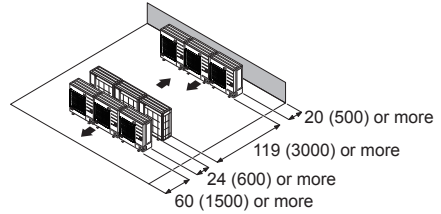

CAUTION

Do not install the outdoor unit in two stage if the drain water may freeze. Otherwise the drainage from the upper unit may form ice and cause a malfunction of the lower unit.

NOTES:

- If the space is larger than stated above, the condition will be the same as when there is no obstacle.
- When installing the outdoor unit, be sure to open the front and left side to obtain better operation efficiency.

3.3. Transporting the unit

WARNING

Do not touch the fins. Otherwise, personal injury could result.

CAUTION

When carrying the unit, hold the handles on the right and left sides and be careful. If the outdoor unit is carried from the bottom, hands or fingers may be pinched.

Be sure to hold the handles on the sides of the unit. Otherwise, holding the suction grille on the sides of the unit may cause deformation.

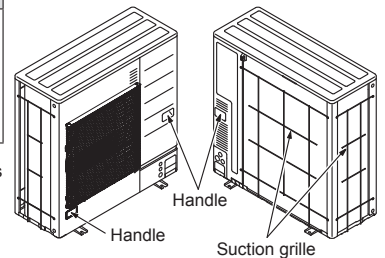

3.4. Mounting the unit

- Install the outdoor unit without slant. (within 3 degrees)
- Install 4 anchor bolts at the locations indicated with arrows in the figure.
- To reduce vibration, do not install the unit directly on the ground. Install it on a secure base (such as concrete blocks).
- The foundation shall support the legs of the unit and have a width of 2 in (50 mm) or more.
- Depending on the installation conditions, the outdoor unit may spread its vibration during operation, which may cause noise and vibration. Therefore, attach damping materials (such as damping pads) to the outdoor unit during installation.
- Install the foundation, making sure that there is enough space for installing the connection pipes.
- Secure the unit to a solid block using foundation bolts. (Use 4 sets of commercially available M10 bolts, nuts, and washers.)
- The bolts should protrude 13/16 in (20 mm). (Refer to the figure.)
- If overturning prevention is required, purchase the necessary commercially available items.

[Unit: in (mm)]

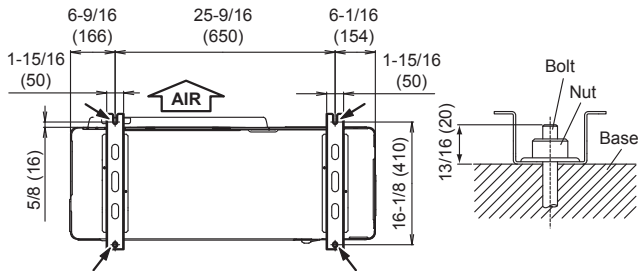

- Do not install directly on the ground, this may result in equipment failure.
- Provide ample space for ice buildup from condensate between the bottom of the unit and the flat surface on which it is mounted. Otherwise, there is risk that the drainage water will freeze between the device and the surface, disabling drainage.

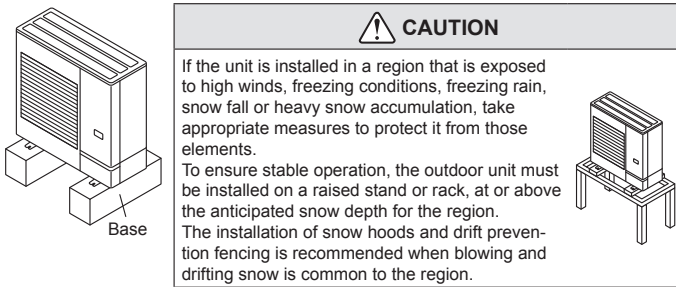

3.5. Drain installation

CAUTION

- Perform drain work in accordance with this Manual, and ensure that the drain water is properly drained. If the drain work is not carried out correctly, water may drip down from the unit, wetting the furniture.
- When the outdoor temperature is 32 °F (0 °C) or less, do not use the accessory drain pipe and drain cap. If the drain pipe and drain cap are used, the drain water in the pipe may freeze in extremely cold weather.

- If you are installing the drain pipe and drain caps, provide a working space under the base of the outdoor unit.
- As the drain water flows out of the outdoor unit during heating operation, install the drain pipe and connect it to a commercial 5/8 in (16 mm) hose.
- When installing the drain pipe, plug all the holes other than the drain pipe mounting hole in the bottom of the outdoor unit with putty so there is no water leakage.

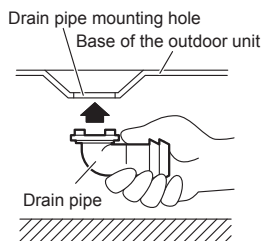

[Unit: in (mm)]

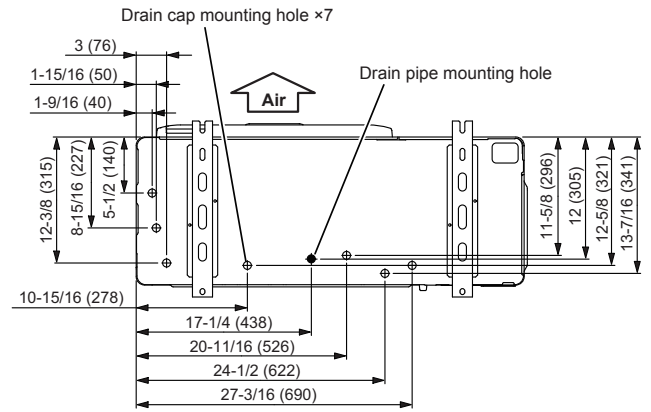

3.6. Removing and replacing parts

3.6.1. Service panel removal

- (1) Remove the tapping screws. (2 places)
- (2) Remove the service panel by pushing downwards.

3.6.2. Installing the service panel

- (1) Align the hooks (3 places) on the "service panel" with the hook holes (3 places) on the outdoor unit and push up the "service panel".
- (2) Replace the tapping screws. (2 places)

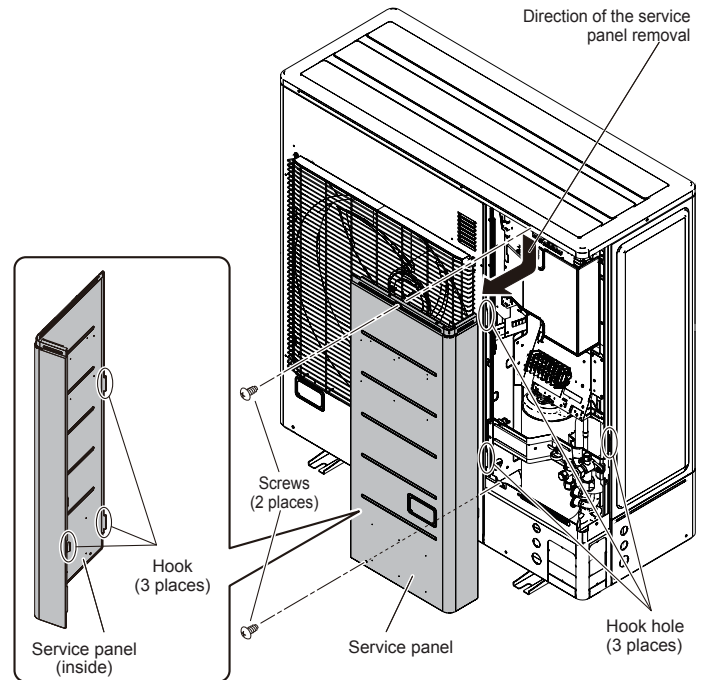

3.7. Opening the knockout hole

CAUTION

- Be careful not to deform or scratch the panel while opening the knockout holes.
- To protect the piping insulation after opening a knockout hole, remove any burrs from the edge of the hole. It is recommended to apply rust prevention paint to the edge of the hole.
- Pipes can be connected from 4 directions, front, lateral side, rear side and bottom. (Fig. A, B)
- When connecting at the bottom, remove the service panel and piping cover on the front of the outdoor unit, and open the knockout hole provided at the bottom corner of the piping outlet.
- It can be installed as shown on "Fig. B" cutting out the 2 slits as indicated on "Fig. C". (When cutting slits, use a steel saw.)

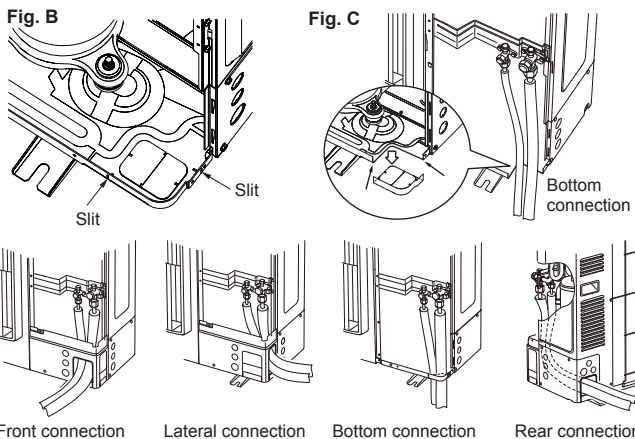
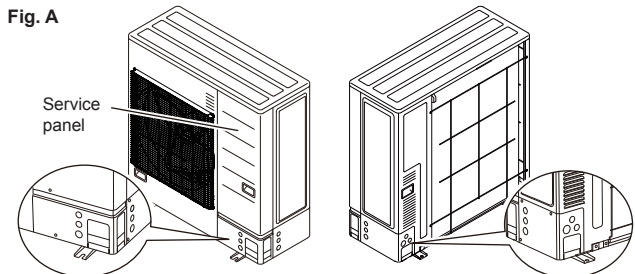

3.8. Pipe installation

CAUTION

- Do not use mineral oil on a flared part. Prevent mineral oil from getting into the system as this would reduce the lifetime of the units.
- While welding the pipes, be sure to blow dry nitrogen gas through them.
- The maximum lengths of this product are shown in the table. If the units are further apart than this, correct operation cannot be guaranteed.

Flaring

Use special pipe cutter and flare tool exclusive for R410A.

- Cut the connection pipe to the necessary length with a pipe cutter.
- Hold the pipe downward so that the cuttings will not enter the pipe and remove any burrs.
- Insert the flare nut (always use the flare nut attached to the indoor and outdoor units respectively) onto the pipe and perform the flare processing with a flare tool. Leakage of refrigerant may result if other flare nuts are used.
- Protect the pipes by pinching them or with tape to prevent dust, dirt, or water from entering the pipes.

Check if [L] is flared uniformly and is not cracked or scratched.

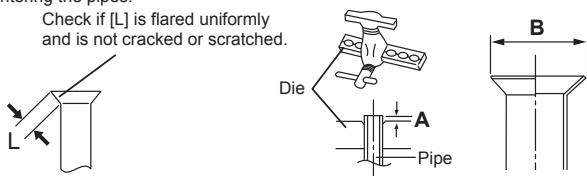

Pipe outside diameter [in (mm)]	Dimension A [in (mm)]	Dimension B $0 \begin{smallmatrix} (0) \\ \pm 0.15 \end{smallmatrix} (-0.4)$ [in (mm)]
	Flare tool for R410A, clutch type	
1/4 (6.35)	0 to 0.020 (0 to 0.5)	3/8 (9.1)
3/8 (9.52)		1/2 (13.2)
1/2 (12.70)		5/8 (16.6)
5/8 (15.88)		3/4 (19.7)
3/4 (19.05)		15/16 (24.0)

When using conventional (R22) flare tools to flare R410A pipes, the dimension A should be approximately 0.020 in (0.5 mm) more than indicated in the table (for flaring with R410A flare tools) to achieve the specified flaring. Use a thickness gauge to measure the dimension A. It is recommended that a R410A flaring tool is used.

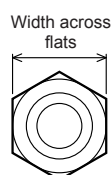

Pipe outside diameter [in (mm)]	Width across flats of Flare nut [in (mm)]
1/4 (6.35)	11/16 (17)
3/8 (9.52)	7/8 (22)
1/2 (12.70)	1 (26)
5/8 (15.88)	1-1/8 (29)
3/4 (19.05)	1-7/16 (36)

Bending pipes

CAUTION

- To prevent breaking of the pipe, avoid sharp bends. Bend the pipe with a radius of curvature of 4 in (100 mm) or more.
- If the pipe is bent repeatedly at the same place, it will break.

- If pipes are shaped by hand, be careful not to collapse them.
- Do not bend the pipes at an angle of more than 90°.
- When pipes are repeatedly bent or stretched, the material will harden, making it difficult to bend or stretch them anymore.
- Do not bend or stretch the pipes more than 3 times.

Flare connection

CAUTION

- Be sure to apply the pipe against the port on the indoor unit and the outdoor unit correctly. If the centering is improper, the flare nut cannot be tightened smoothly. If the flare nut is forced to turn, the threads will be damaged.
- Do not remove the flare nut from the indoor unit pipe until immediately before connecting the connection pipe.
- After installing the piping, make sure that the connection pipes do not touch the compressor or outer panel. If the pipes touch the compressor or outer panel, they will vibrate and produce noise.

- Detach the caps and plugs from the pipes.
- Center the pipe against the port on the outdoor unit, and then turn the flare nut by hand.
- Tighten the flare nut of the connection pipe at the outdoor unit valve connector.
- After tightening the flare nut by hand, use a torque wrench to fully tighten it.

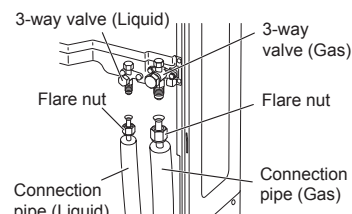

CAUTION

Hold the torque wrench at its grip, keeping it in the right angle with the pipe, in order to tighten the flare nut correctly.

Outer panel may be distorted if fastened only with a wrench. Be sure to fix the elementary part with a holding wrench (spanner) and fasten with a torque wrench (refer to the right diagram). Do not apply force to the blank cap of the valve or hang a wrench, etc., on the cap. If blank cap is broken, it may cause leakage of refrigerant.

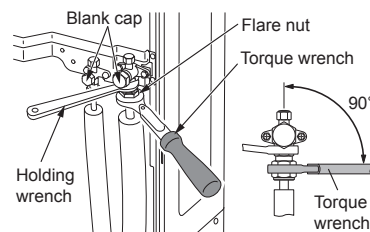

Flare nut [in (mm)]	Tightening torque [lbf-ft. (N-m)]
1/4 (6.35) dia.	11.8 to 13.3 (16 to 18)
3/8 (9.52) dia.	23.6 to 31.0 (32 to 42)
1/2 (12.70) dia.	36.1 to 45.0 (49 to 61)
5/8 (15.88) dia.	46.5 to 55.3 (63 to 75)
3/4 (19.05) dia.	66.4 to 81.1 (90 to 110)

Handling precautions for the valves

- Mounted part of Blank cap is sealed for protection.
- Fasten blank cap tightly after opening valves.

Operating the valves

- Use a hexagon wrench (size 4 mm).

Opening:

- Insert the hexagon wrench into the valve shaft, and turn it counterclockwise.
- Stop turning when the valve shaft can no longer be turned. (Open position)

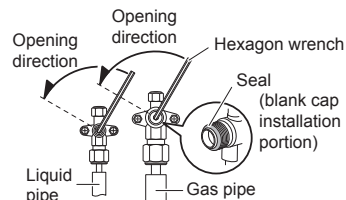

Closing:

- Insert the hexagon wrench into the valve shaft, and turn it clockwise.
- Stop turning when the valve shaft can no longer be turned. (Closed position)

3.9. Sealing test

⚠ WARNING

- Before operating the compressor, install the pipes and securely connect them. Otherwise, if the pipes are not installed and if the valves are open when the compressor operates, air could enter the refrigeration cycle. If this happens, the pressure in the refrigeration cycle will become abnormally high and cause damage or injury.
- After the installation, make sure there is no refrigerant leakage. If the refrigerant leaks into the room and becomes exposed to a source of fire such as a fan heater, stove, or burner, it produces a toxic gas.

⚠ CAUTION

- Use only nitrogen gas.
- Never use refrigerant gas, oxygen, flammable gas or poisonous gas to pressurize the system. (If oxygen is used. There is danger of an explosion.)
- Do not shock during sealing test. It can rupture the pipes and cause serious injury.
- Do not turn on the power unless all operations are complete.
- Do not block the walls and the ceiling until the sealing test and charging of the refrigerant gas have been completed.

After connecting the pipes, perform a sealing test.
Recheck that the spindle of the 3-way valve are closed before performing a sealing test.

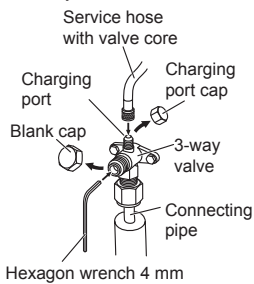

Pour nitrogen gas through both the liquid pipe and the gas pipe.
Pressurize nitrogen gas to 609 psi (4.2 MPa) to perform the sealing test.

Check all flare connection and brazed areas.
Then, check that the pressure has not decreased.
Compare the pressures after pressurizing and letting it stand for 24 hours, and check that the pressure did not decrease.

- * When the outdoor temperature changes 9 degrees F (5 degrees C), the test pressure changes 7.25 psi (0.05 MPa.).
- If the pressure has dropped, the pipe joints may be leaking.

If a leakage is found, immediately repair it and perform a sealing test again.
* Decrease the pressure of nitrogen gas before brazing.

After completing the sealing test, release the nitrogen gas from both valves.
Release the nitrogen gas slowly.

3.10. Vacuum process

⚠ CAUTION

- Do not turn on the power unless all operations are complete.
- If the system is not evacuated sufficiently, its performance will drop.
- Be sure to evacuate the refrigerant system using a vacuum pump.
- The refrigerant pressure may sometimes not rise when a closed valve is opened after the system is evacuated using a vacuum pump. This is caused by the closure of the refrigerant system of the outdoor unit by the electronic expansion valve. This will not affect the operation of the unit.
- Use a clean gauge manifold and charging hose that were designed specifically for use with R410A. Using the same vacuum equipment for different refrigerants may damage the vacuum pump or the unit.
- Do not purge the air with refrigerants, but use a vacuum pump to evacuate the system.
 - If moisture enter the piping, follow below. (i.e., if doing work during the rainy season, if the actual work takes long enough that condensation may form on the inside of the pipes, if rain might enter the pipes during work, etc.)
 - After operating the vacuum pump for 2 hours, pressurize to 7.25 psi (0.05 MPa) (i.e., vacuum breakdown) with nitrogen gas, then depressurize down to 500 microns (-100.7 kPa) for an hour using the vacuum pump (vacuum process).
 - If the pressure does not reach 500 microns (-100.7 kPa) even after depressurizing for at least 2 hours, repeat the vacuum breakdown - vacuum process perform triple evacuation procedure as necessary to bring the vacuum down to 500 microns (-100.7 kPa) or lower.
- After vacuum process, maintain the vacuum for an hour and make sure the pressure does not rise by monitoring with a vacuum gauge.

Evacuation procedure

- (1) Remove the caps of the gas pipe and liquid pipe and check that the valves are closed.
- (2) Remove the charging cap.
- (3) Connect a vacuum pump and a pressure gauge to a charging hose and connect it to the charging port.
- (4) Activate the vacuum pump and vacuum the indoor unit and connection piping until the pressure gauge becomes 500 microns (-100.7 kPa).
Evacuate from both the gas pipe and the liquid pipe.
- (5) Continue evacuating the system for 1 hour after the pressure gauge reads 500 microns (-100.7 kPa).
- (6) Remove the charging hose and reinstall the charging cap.

		Tightening torque [lbs·ft (N·m)]
Blank cap [in (mm)]	1/4 (6.35)	11.8 to 13.3 (16 to 18)
	3/8 (9.52)	23.6 to 31.0 (32 to 42)
	1/2 (12.70)	36.1 to 45.0 (49 to 61)
	5/8 (15.88)	46.5 to 55.3 (63 to 75)
	3/4 (19.05)	66.4 to 81.1 (90 to 110)
Charging port cap		9.2 to 11.8 (13 to 16)

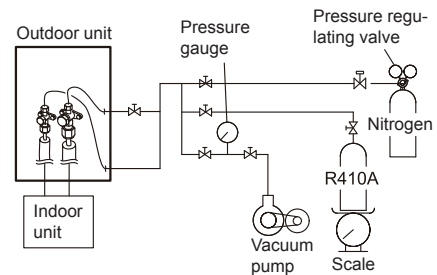

3.11. Additional charging

⚠ WARNING

When moving and installing the air conditioner, do not mix gas other than the specified refrigerant R410A inside the refrigerant cycle.
If air or other gas enters the refrigerant cycle, the pressure inside the cycle will rise to an abnormally high value and cause breakage, injury, etc.

⚠ CAUTION

- Do not turn on the power unless all operations are complete.
- After vacuuming the system, add refrigerant.
- Do not charge the system with a refrigerant other than R410A.
- Always keep to the limit on the total amount of refrigerant. Exceeding the limit on the total amount of refrigerant will lead to malfunction during charging of refrigerant.
- Do not reuse recovered refrigerant.
- When charging the refrigerant R410A, always use an electronic scales for refrigerant charging (to measure the refrigerant by weight). Adding more refrigerant than the specified amount will cause a malfunction.
- When charging the refrigerant, take into account the slight change in the composition of the gas and liquid phases, and always charge from the liquid phase side whose composition is stable. Adding refrigerant through the gas pipe will cause a malfunction.
- Add refrigerant by charging the system with the refrigerant in the liquid state. If the refrigerant cylinder is equipped with a siphon, it is not necessary to place the cylinder upright.
- Check if the steel cylinder has a siphon installed or not before filling. (There is an indication "with siphon for filling liquid" on the steel cylinder.)

Filling method for cylinder with siphon

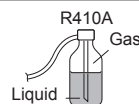

Set the cylinder vertical and fill with the liquid.
(Liquid can be filled without turning bottom up with the siphon inside.)

Filling method for other cylinders

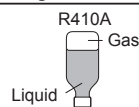

Turn bottom up and fill with liquid.
(Be careful to avoid turning over the cylinder.)

- Be sure to use the special tools for R410A for pressure resistance and to avoid mixing of impure substances.
- If the units are further apart than the maximum pipe length, correct operation can not be guaranteed.
- Make sure to back closing valve after refrigerant charging. Otherwise, the compressor may fail.
- Minimize refrigerant release to the air. Excessive release is prohibited under the Freon Collection and Destruction Law.

■ Gas leakage inspection

⚠ CAUTION

After connecting the piping, check the all joints for gas leakage with gas leak detector.

3.12. Electrical wiring

3.12.1. Notes for electrical wiring

⚠ WARNING

- Wiring connections must be performed by a qualified person in accordance with the specifications. The voltage rating for this product is 208/230 V at 60 Hz. It should be operated within the range of 187 to 253 V.
- Before connecting the wires, make sure the power supply is off.
- Never touch electrical components immediately after the power supply has been turned off. Electrical shock may occur. After turning off the power, always wait 10 minutes or more before touching electrical components.
- When installing this system in high humidity locations, install using ground fault equipment breakers (often referred to in other countries as an ELCB [earth leakage current breaker]) to reduce the risk of leaking current which may result in electric shock or potential fire.
- Make sure to perform grounding work. Improper grounding work can cause electric shocks.
- A circuit breaker is installed in the permanent wiring. Always use a circuit that can trip all the poles of the wiring and has an isolation distance of at least 1/8 in (3 mm) between the contacts of each pole.
- Be sure to install a breaker of the specified capacity.
When selecting breaker, comply with the laws and the regulations of each country. One breaker must be installed on the power supply of the outdoor unit. Wrong selection and setup of the breaker will cause electric shock or fire.
- Do not modify power cable, use extension cable or branch wiring. Improper use may cause electric shock or fire by poor connection, insufficient insulation or over current.
- Do not connect AC power supply to the transmission line terminal board. Improper wiring can damage the entire system.
- Connect the connector cable securely to the terminal. Check no mechanical force bears on the cables connected to the terminals. Faulty installation can cause a fire.
- Use ring terminals and tighten the terminal screws to the specified torques, otherwise, abnormal overheating may be produced and possibly cause serious damage inside the unit.
- Make sure to secure the insulation portion of the connector cable with the cable clamp. Damaged insulation can cause a short circuit.
- Fix cables so that cables do not make contact with the pipes (especially on high pressure side). Do not make power supply cable and transmission cable come in contact with valves (Gas).
- Never install a power factor improvement condenser. Instead of improving the power factor, the condenser may overheat.
- Be sure to perform the grounding work.
Do not connect grounding wires to a gas pipe, water pipe, lightning rod or grounding wire for a telephone.
 - Connection to a gas pipe may cause a fire or explosion if gas leaks.
 - Connection to a water pipe is not an effective grounding method if PVC pipe is used.
 - Connection to the grounding wire of a telephone or to a lightning rod may cause a dangerously abnormal rise in the electrical potential if lightning strikes.
 - Improper grounding work can cause electric shocks.
- Securely install the electrical box cover on the unit. An improperly installed service panel can cause serious accidents such as electric shock or fire through exposure to dust or water.
- If the supply cable is damaged, it must be replaced by the manufacturer, its service agent or similarly qualified persons in order to avoid a hazard.
- Do not connect the AC power supply to the transmission line terminal board. Improper wiring can damage the entire system.

⚠ CAUTION

- The primary power supply capacity is for the air conditioner itself, and does not include the concurrent use of other devices.
- Connect the power cables in positive phase sequence. If there is a missing phase connection, the unit will not operate normally.
- If the electrical power is inadequate, contact your electric power company.
- Install a breaker in a location that is not exposed to high temperatures.
If the temperature surrounding the breaker is too high, the amperage at which the breaker cuts out may decrease.
- When using an earth leakage breaker that has been designed solely for ground fault protection, be sure to install a fuse-equipped switch or circuit breaker.
- This system uses an inverter, which means that it must be used an earth leakage breaker that can handle harmonics in order to prevent malfunctioning of the earth leakage breaker itself.
- When the electrical switchboard is installed outdoors, place it under lock and key so that it is not easily accessible.
- Never bundle the power supply cable and connection cable, remote control cable together. Separate these cable by 2 in (50 mm) or more. Bundling these cables together will cause miss operation or breakdown.
- Do not use crossover power supply wiring for the outdoor unit.
- If the temperature surrounding the breaker is too high, the amperage at which the breaker cuts out may decrease.
- When the electrical switchboard is installed outdoors, place it under lock and key so that it is not easily accessible.
- Start wiring work after closing branch switch and over current breaker.
- Connection cable between indoor unit and outdoor unit is 208/230 V.
- Be sure not to remove thermistor sensor etc. from power wiring and connection wiring. Compressor may fail if operated while removed.
- Always keep to the maximum length of the connection cable. Exceeding the maximum length may lead to erroneous operation.
- Do not start operation until the refrigerant is charged completely. The compressor will fail if it is operated before the refrigerant piping charging is complete.
- The static electricity that is charged to the human body can damage the control PC Board when handling the control PC Board for address setting, etc.
Keep caution to the following points.
Provide the grounding of Indoor unit, Outdoor unit and Option equipment.
Cut off the power supply (breaker).
Touch the metal section (such as the unpainted control box section) of the indoor or outdoor unit for more than 10 seconds. Discharge the static electricity in your body. Never touch the component terminal or pattern on the PC Board.
- Be careful not to generate a spark as follows for using a flammable refrigerant.
 - Do not remove the fuse while power is on.
 - Do not disconnect plug from the wall outlet and the wiring while the power is on.
 - It is recommended to position the outlet connection in a high position. Place the cords so that they do not get tangled.
- Confirm the indoor unit model name before connecting.

3.12.2. Knockout hole for wiring

⚠ CAUTION

- Be careful not to deform or scratch the panel while opening the knockout holes.
- After opening the knockout hole, remove the burr on the edges to prevent snapping of cables.
It is recommended to apply rust proof paint on the edges to prevent rust.

Knockout holes are provided for wiring.

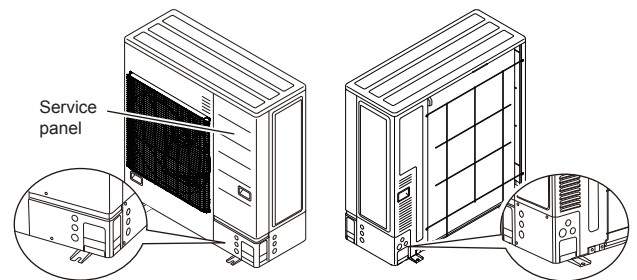

Knockout holes are provided 3 each in the same size in front, lateral and rear sides.

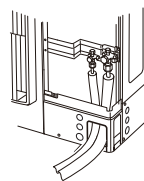

Front connection

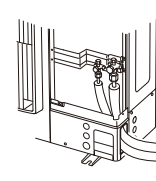

Lateral connection

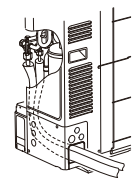

Rear connection

How to connect wiring to the terminal

Caution when wiring cable

- When stripping off the coating of a lead wire, always use a special tool such as a wire stripper. If there is no special tool available, carefully strip the coating with a knife etc.
- Use ring terminals with insulating sleeves as shown in the figure below to connect to the terminal block.
 - Securely clamp the ring terminals to the wires using an appropriate tool so that the wires do not come loose.

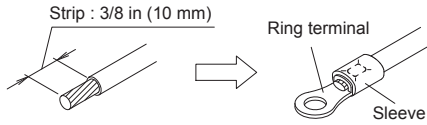

- Use the specified wires, connect them securely, and fasten them so that there is no stress placed on the terminals.
- Use an appropriate screwdriver to tighten the terminal screws. Do not use a screwdriver that is too small, otherwise, the screw heads may be damaged and prevent the screws from being properly tightened.
- Do not tighten the terminal screws too much, otherwise, the screws may break.

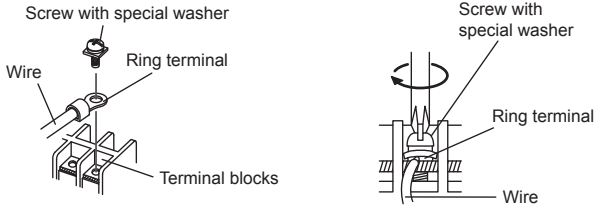

- Refer to the following table for the terminal screw tightening torques.

Tightening torque [lbs-in (N-m)]	
M4 screw	10.6 to 15.9 (1.2 to 1.8)
M5 screw	17.7 to 26.5 (2.0 to 3.0)

3.12.3. Wiring method

Connection diagrams

CAUTION

When connecting the power supply cable, make sure that the phase of the power supply matches with the phase of the terminal board. If the phases do not match, the compressor will rotate in reverse and will not be able to compress.

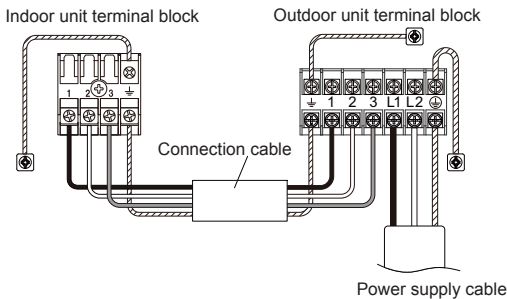
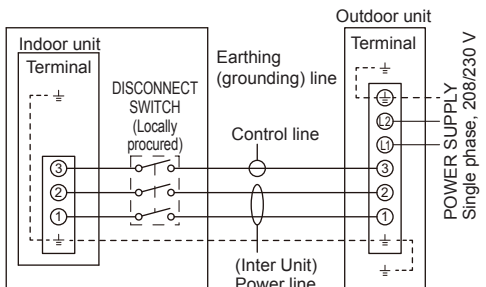

NOTE: Factory installed protective inline fuses for indoor units' conductors are installed on the Power Supply PCB.

Cable preparation

Keep the earth (ground) wire longer than the other wires.

NOTE: When using a sealed cable

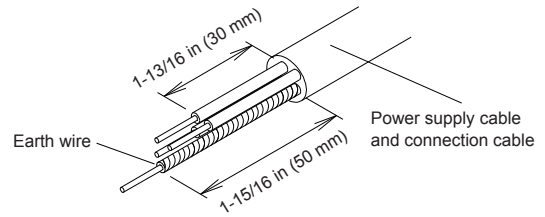

Wiring procedure

- Remove the service panel. And connect the cable to the terminal in accordance with the terminal name plate.
- Use a ring terminal to connect the electric cables to the power supply terminal board.
- Keep the earth cable longer than the other cables.
- After connecting the electric cable, secure them with a cable clamp.
- Connect the cable without applying excessive tension.
- Use the specified cable type and connect the cable securely.

Secure with a cable clamp as shown in the following figure.

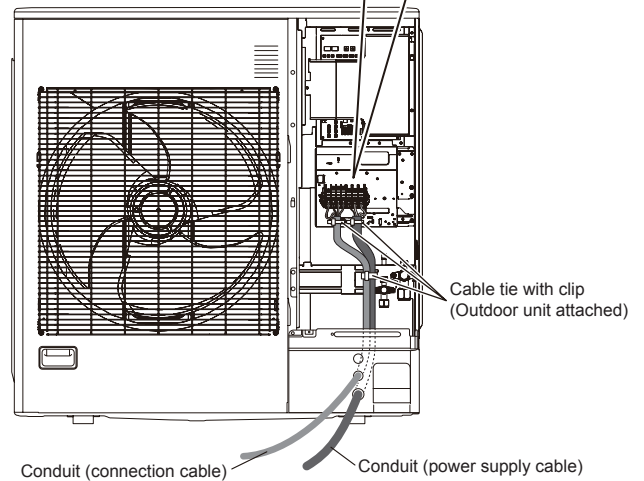
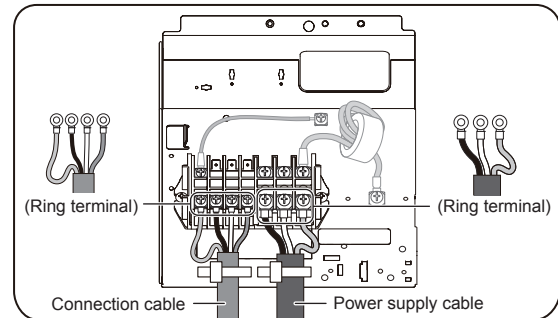

■ Conduit installation

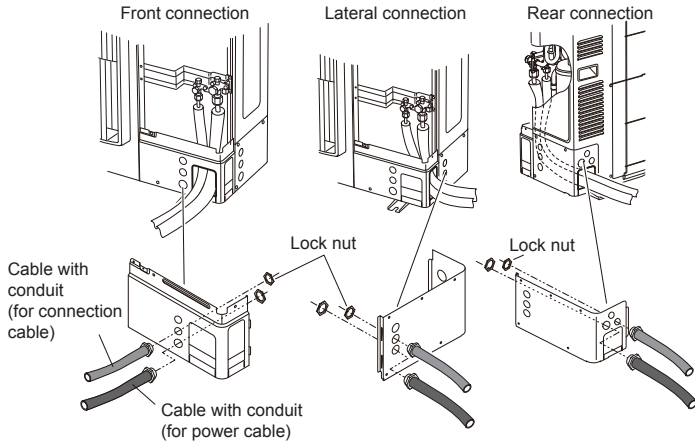

Fix the conduit with the supporters as shown below.

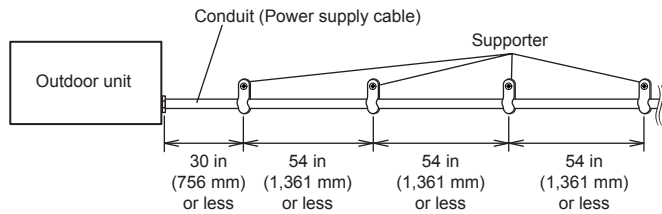

4. HOW TO OPERATE DISPLAY UNIT

4.1. Various setting methods

⚠ WARNING

Never touch electrical components such as the terminal blocks or reactor except the switch on the display board. It may cause a serious accident such as electric shock.

⚠ CAUTION

- Once refrigerant charging is completed, be sure to open the valve prior to performing the local settings. Otherwise, the compressor may fail.
- Discharge any static electricity from your body before touching the push switches. Never touch any terminal or pattern of any parts on the control board.

The positions of the switches on the outdoor unit control board are shown in the figure below.

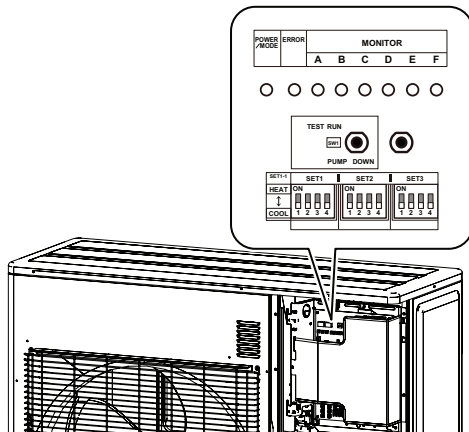

4.1.1. Setting method

- Be sure to disconnect the power source or turn off the breaker.
- Change the DIP switch setting according to the required setting.

- Various settings can be adjusted by changing DIP switches and push switches on the board of the outdoor unit.
- The printed characters for the LED display are shown below.

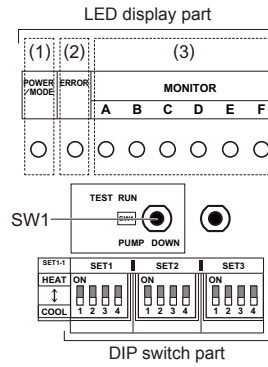

4.1.2. Description of display

LED display lamp		Function or operation method	
(1)	POWER/MODE	Green	<ul style="list-style-type: none"> Turns on when the power supply is ON (Including when error occurs). Indicate the MODE by the number of flashes when the installation function is active.
(2)	ERROR	Red	<ul style="list-style-type: none"> Flashes at high-speed when there is an error.
(3)	MONITOR	A	<ul style="list-style-type: none"> Displays the location and contents of errors when there is an error. (Refer to 8. ERROR CODE for details.)
		B	
		C	
		D	
		E	
		F	

Switch		Function or operation method	Factory setting
SW1	Push	<ul style="list-style-type: none"> For the test run start and stop. For the pump down start and stop. 	—
SET1-1	DIP	<ul style="list-style-type: none"> For selecting cooling or heating during test operation. 	OFF
SET1-2	DIP	<ul style="list-style-type: none"> For switching SW1 operation. 	OFF
SET1-3	DIP	<ul style="list-style-type: none"> For switching the base heater. 	OFF
SET1-4	DIP	(Setting prohibited)	OFF (Do not change)
SET2-1	DIP	<ul style="list-style-type: none"> For selecting outdoor unit low noise operation function. To use this function, the Central remote controller (option) is necessary. 	OFF
SET2-2	DIP	(Setting prohibited)	OFF (Do not change)
SET2-3	DIP	(Setting prohibited)	OFF (Do not change)
SET2-4	DIP	(Setting prohibited)	OFF (Do not change)
SET3-1	DIP	(Setting prohibited)	OFF (Do not change)
SET3-2	DIP	(Setting prohibited)	OFF (Do not change)
SET3-3	DIP	(Setting prohibited)	OFF (Do not change)
SET3-4	DIP	(Setting prohibited)	OFF (Do not change)

Be sure to disconnect the power source or turn off the breaker when changing the DIP switch.

4.2. Base heater forced off function

36 model

The power to the Base heater can be cut off by changing the DIP switch setting.

SET1-3	Setting
ON	
OFF	Forced off setting

4.3. Outdoor unit low noise operation function (option)

Change the Outdoor unit low noise operation by using this setting. The Central remote controller (option) is necessary to use this function.

SET2-1	Setting
ON	Lower
OFF	Low

CAUTION

When the low noise operation function is working, cooling and heating capacity will decrease.
When changing the settings, explain to the customer beforehand that the capacity decreases.

5. TEST RUN

CAUTION

Always connect the power supply 12 hours prior to the start of the operation in order to protect the compressor.

(1) Indoor unit

- ① Is the drain normal?
- ② Is there any abnormal noise and vibration during operation?

(2) Outdoor unit

- ① Is there any abnormal noise and vibration during operation?
 - ② Will noise, wind, or drain water from the unit disturb the neighbors?
 - ③ Is there any gas leakage?
- Do not operate the air conditioner in the test running state for a long time.
 - For the operation method of the test run for indoor unit and central remote controller, refer to the operating manual and perform operation check.

5.1. TEST RUN method

Be sure to temporarily disconnect the power supply or turn off the breaker before changing the DIP switch settings.

- (1) Check the 3-way valves (both at the liquid side and gas side) are opened. Confirm that the DIP switch SET1-2 is switched OFF.
- (2) Set the operation mode to "COOL" or "HEAT". If you wish to change the DIP switch SET1-1 to "HEAT", switch it after temporarily disconnecting the power supply or turning off the breaker switching the power off.

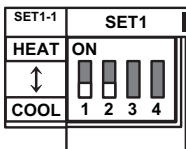

- In the first test run, be sure to set the operation mode to "COOL".
- The operation mode cannot be switched between "COOL" and "HEAT" during the test run. To switch the operation mode between "COOL" and "HEAT", stop the test run, switch the operation mode, and then start the test run again.

- (3) Press "TEST RUN" switch for more than 3 seconds.
The POWER / MODE LED flashes once.

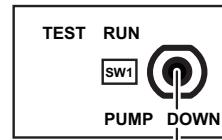

SW1

POWER / MODE	ERROR	MONITOR					
		A	B	C	D	E	F



Blink
(1 time)

- (4) Confirm operating status.
- (5) Press "TEST RUN" switch for more than 3 seconds.

POWER / MODE	ERROR	MONITOR					
		A	B	C	D	E	F



POWER/MODE LED will turn on, and test run stops.

6. FINISHING

6.1. Installing insulation

- Install insulation material after conducting "3.9. Sealing test".
- To prevent condensation and water droplets, install insulation material on the refrigerant pipe.
- Use insulation with heat resistance above 248 °F (120 °C).
- Refer to the following table to determine the thickness of the insulation material.

■ Selection of insulation

[Use an insulation material with equal heat transmission rate or below 0.023 BTU/ft·h·°F (0.040 W/m·k)]

		Insulation material minimum thickness [in (mm)]			
Relative humidity		≤ 70%	≤ 75%	≤ 80%	≤ 85%
Pipe diameter [in (mm)]	1/4 (6.35)	5/16 (8)	3/8 (10)	1/2 (13)	11/16 (17)
	3/8 (9.52)	3/8 (9)	7/16 (11)	9/16 (14)	11/16 (18)
	1/2 (12.70)	3/8 (10)	1/2 (12)	9/16 (15)	3/4 (19)
	5/8 (15.88)	3/8 (10)	1/2 (12)	5/8 (16)	13/16 (20)
	3/4 (19.05)	3/8 (10)	1/2 (13)	5/8 (16)	13/16 (21)

* When the ambient temperature and relative humidity exceed 89.6 °F (32 °C) (DB) and 85% respectively, strengthen the heat insulation of refrigerant pipe.

6.2. Filling with putty

WARNING

Fill the piping holes and wiring holes with putty (supplied locally) to avoid any gap (Fig A). If small animals such as insects enter the external unit, a short circuit may be caused near electrical components in the service panel.

If the outdoor unit is installed at a level that is higher than the indoor unit, the water that has condensed in the 3-way valve of the outdoor unit could travel to the indoor unit. Therefore, use putty in the space between the pipe and the insulation to prevent the entry of water to the indoor units.

Fig. A

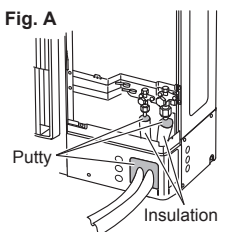

7. CUSTOMER GUIDANCE

Explain the following to the customer in accordance with the operating manual:

- (1) Starting and stopping method, operation switching, temperature adjustment, timer, air flow adjustment, and other remote control unit operations.
- (2) Air filter removal and cleaning.
- (3) Give the operating manual and installation instruction sheet to the customer.

8. ERROR CODE

- If an error occurs, the LED will light up to display the error location and the error code.

8.1. In the event of an error

- The error LED flashes quickly.

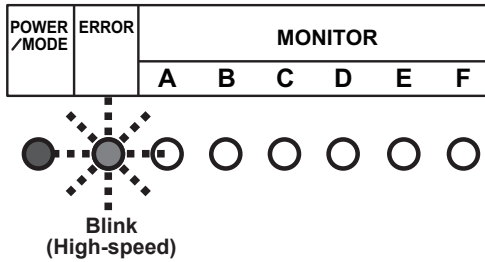

8.2. Error location display

- LEDs A to F of MONITOR light up and display the error location. In the case of an overall error, LEDs A to F of MONITOR do not light up.

Example) Coil error in indoor unit A

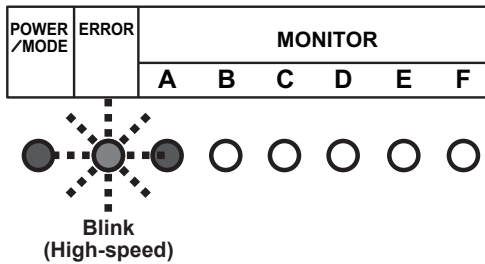

8.3. Error code display

- While the error is occurring, briefly press SW1. The error code is displayed.

Example) Coil error (Error code = 9A.1)

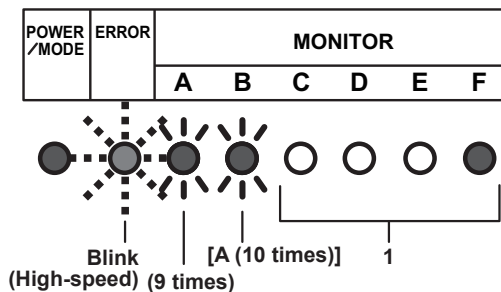

Display mode

LED on: ●

LED off: ○

Blink: (0.5s Light on / 0.5s Light off)

Number of blinking: ()

For MONITOR (A and B)

A: 10 times

C: 11 times

F: 12 times

J: 13 times

P: 14 times

U: 15 times

C	D	E	F	
○	○	○	●	→ 1
○	○	●	○	→ 2
○	○	●	●	→ 3
○	●	○	○	→ 4
○	●	○	●	→ 5
○	●	●	○	→ 6
○	●	●	●	→ 7
●	○	○	○	→ 8
●	○	○	●	→ 9
●	○	●	○	→ A
●	○	●	●	→ C
●	●	○	○	→ F
●	●	○	●	→ J
●	●	●	○	→ P
●	●	●	●	→ U

Error code	Error type
11.3	Serial communication error
11.4	Serial communication error during operation
16.5	Communication error between controller and outdoor unit
22.1	Indoor unit capacity error
5U.1	Indoor unit error
62.1	PCB model information error
62.3	EEPROM access error
62.8	EEPROM data corruption error
63.1	Inverter error
65.3	IPM error (Trip terminal L error)
71.1	Discharge temp. sensor error
72.1	Compressor temp. sensor error
73.2	Heat ex. middle temp. sensor error
73.3	Heat ex. liquid temp. sensor error
74.1	Outdoor temp. sensor error
75.1	Suction gas temp. sensor error
76.1	Valve sensor error
76.2	
77.1	Heat sink temp. sensor error
84.1	Current sensor 1 error (stoppage permanently)
86.1	Discharge pressure sensor error
86.4	High pressure switch 1 error
94.1	Trip detection
95.1	Compressor motor control error (stoppage permanently)
97.3	Fan motor 1 error (Duty error)
98.3	Fan motor 2 error (Duty error)
99.1	4-way valve error
9A.1	Coil 1 (expansion valve 1) error
A1.1	Discharge temperature 1 error (stoppage permanently)
A3.1	Compressor 1 temperature error

9. PUMP DOWN

WARNING

During the pump down operation, make sure that compressor is off before you remove the refrigerant piping. Do not remove the connection pipe while the compressor is in operation with valve open. This may cause abnormal pressure in the refrigeration cycle that leads to breakage and even injury.

■ Pump down operation

When moving or discarding the air conditioner, in order to consider the environment and avoid the discharge of refrigerant to the atmosphere, pump down according to the following procedure.

- (1) Connect the pressure gauge to the charging port.
- (2) Change the DIP switch on the board (SET1-2) to ON*1

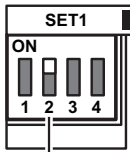

*Be sure the power supply is disconnected on the breaker is turned off when changing the DIP switch.

*1: DIP switch (SET1-2)

- (3) To start operation, press the [PUMP DOWN] switch*2 for 3 seconds or press after the power has been on for 3 min.

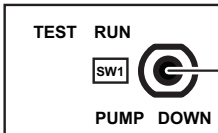

*2: Push switch (SW1)

During pump down, the LED (POWER/MODE) will flash 3 times consecutively.

POWER /MODE	ERROR	MONITOR					
		A	B	C	D	E	F



NOTE:

If the [PUMP DOWN] switch is pressed during compressor operation, the compressor will stop, and the operation will start after about 3 min.

- (4) Close the liquid pipe valve.
- (5) When 7.3 psi ~ 0 psi (0.05 MPa ~ 0 MPa) is shown, close the gas pipe valve.
- (6) Stop pump down by pressing the [PUMP DOWN] switch for 3 seconds.
The LED will light as follows.

POWER /MODE	ERROR	MONITOR					
		A	B	C	D	E	F



- (7) Disconnect the power supply or turn off the breaker.

NOTES:

- If the pump down is not stopped by pressing the switch as in step (6), it will stop automatically after 15 min. and the LED will light as follows. If the pump down is complete, disconnect the power supply or turn off the breaker. If not completed open the liquid pipe valve, and then start again from step (3).

POWER /MODE	ERROR	MONITOR					
		A	B	C	D	E	F

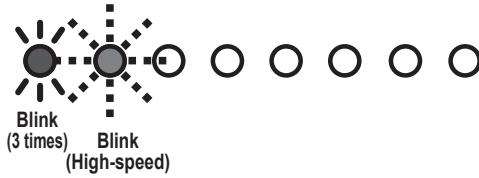

- In order to interrupt the pump down operation, press the [PUMP DOWN] switch again. The LED will return to the original display before starting pump down. (POWER/MODE LED: On)
- The pump down may stop before completion due to error. To complete the pump down, correct the error, open the liquid pipe valve and then start from step (1) again. Otherwise, the refrigerant can be recovered from the service port.

CAUTION

Make sure the refrigerant circuit for any leaks before starting the pump down operation.
Do not proceed with the pump down operation if there is no refrigerant left in the circuit due to bent or broken piping.
During the pump down operation, be sure to turn off the compressor before removing the refrigerant piping.